

# UAC-232

## USB AUDIO CONVERTER

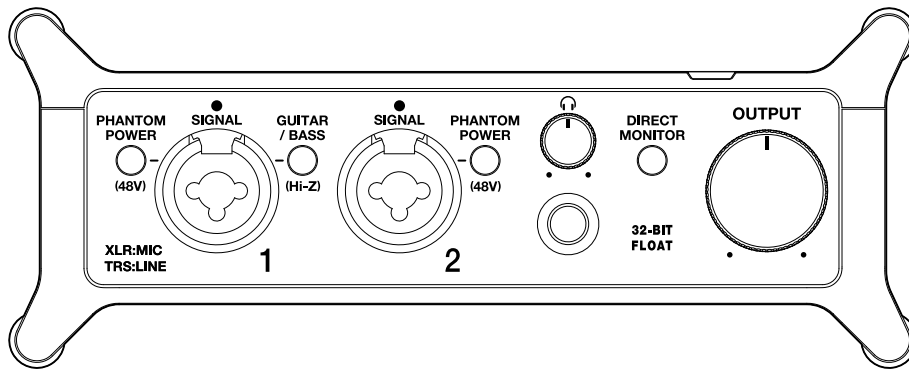

## Operation Manual

You must read the Usage and Safety Precautions before use.

©2023 ZOOM CORPORATION

Copying or reprinting this manual in part or in whole without permission is prohibited.

Product names, registered trademarks and company names in this document are the property of their respective companies. All trademarks and registered trademarks in this document are for identification purposes only and are not intended to infringe on the copyrights of their respective owners.

Proper display is not possible on grayscale devices.

# Notes about this Operation Manual

---

You might need this manual in the future. Always keep it in a place where you can access it easily. The contents of this document and the specifications of the product could be changed without notice.

- Microsoft and Windows are trademarks of the Microsoft corporate group.
- iPadOS, Lightning and Mac are trademarks of Apple Inc.
- App Store is a service mark of Apple Inc.
- IOS is a registered trademark or trademark of Cisco Systems, Inc. and its affiliated companies in the USA and other countries, and it is used under license.
- USB Type-C is a trademark of the USB Implementers Forum.
- Other product names, registered trademarks and company names in this document are the property of their respective companies.
- All trademarks and registered trademarks in this document are for identification purposes only and are not intended to infringe on the copyrights of their respective owners.
- Recording from copyrighted sources, including CDs, records, tapes, live performances, video works and broadcasts, without permission of the copyright holder for any purpose other than personal use is prohibited by law. ZOOM CORPORATION will not assume any responsibility related to infringements of copyrights.

# Contents

---

Notes about this Operation Manual.....	2
UAC-232 overview.....	5
High-quality audio inputs.....	5
Functions of parts.....	10
Connecting to computers.....	13
Preparing for use with a Mac computer.....	14
Preparing for use with a Windows computer.....	15
Connecting to iOS/iPadOS devices.....	18
Using an external power supply.....	19
Connecting instruments and mics.....	20
Connecting instruments.....	21
Connecting mics.....	23
Using direct monitoring.....	25
Adjusting the volume.....	26
Adjusting the output volume.....	26
Adjusting the headphone volume.....	26
Using ZOOM UAC-232 Mix Control.....	27
Installing ZOOM UAC-232 Mix Control.....	27
ZOOM UAC-232 Mix Control Screen.....	28
Adjusting waveform display size.....	30
Overview of Music and Streaming modes.....	31
Adjusting direct monitoring.....	33
Adjusting the streaming mixer.....	34
Enabling the loopback function.....	35
Restoring factory default settings.....	37
Managing the firmware.....	38
Checking the firmware version.....	38
Updating the firmware.....	38
Use example: Making music.....	39
Use example: Web streaming using a computer.....	42
Use example: Web streaming using an iOS/iPadOS device.....	45
Using the included flat cable fasteners.....	48
Mixer diagram.....	49
Terms used in this manual.....	50
Troubleshooting.....	51
Not recognized by computer when connected.....	51
Cannot select or use the UAC-232 device.....	51
The sound of the device connected to the input jack is distorted, too quiet or silent.....	51
Cannot play or record.....	52
Playback sound cannot be heard or is quiet.....	52

Cannot be used with an iOS/iPadOS device..... 52  
Sound breaks up during playback or recording..... 52  
Noise is loud during direct monitoring..... 52  
Specifications.....53

# UAC-232 overview

---

## High-quality audio inputs

Using original dual A/D converter circuits and 32-bit float recording technologies with a maximum sample rate of 192 kHz, the UAC-232 can process input signals as super-high-resolution audio without any need for gain adjustments.

### Audio input with no need for gain adjustment

Dual A/D converter circuits enable recording sound ranging from quiet to loud without making gain adjustments.



## Editing in DAWs and other software

Since 32-bit Float WAV file format is used for recording, the recording audio quality is retained when editing.



# Dual A/D converter circuit overview

The UAC-232 has two A/D converters with different input gains for each input circuit. This design enables high-quality audio recording with a DAW, for example, without the need to adjust input gain settings, a step that is normally indispensable.

## Providing amazing dynamic range

By combining two A/D converters, a wide dynamic range not possible with a single A/D converter has been realized.

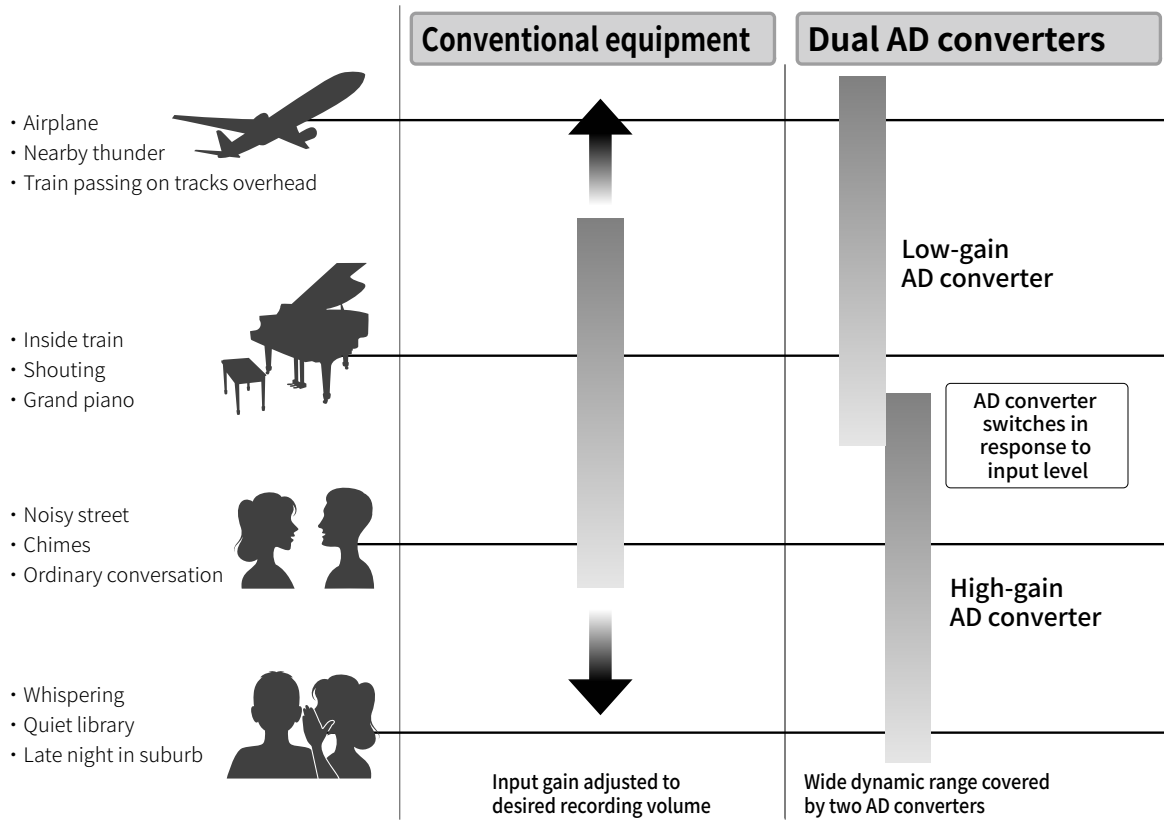

## Switching between two A/D converters

The UAC-232 constantly monitors data from the two A/D converters, and automatically selects the one that provides the best recording results.

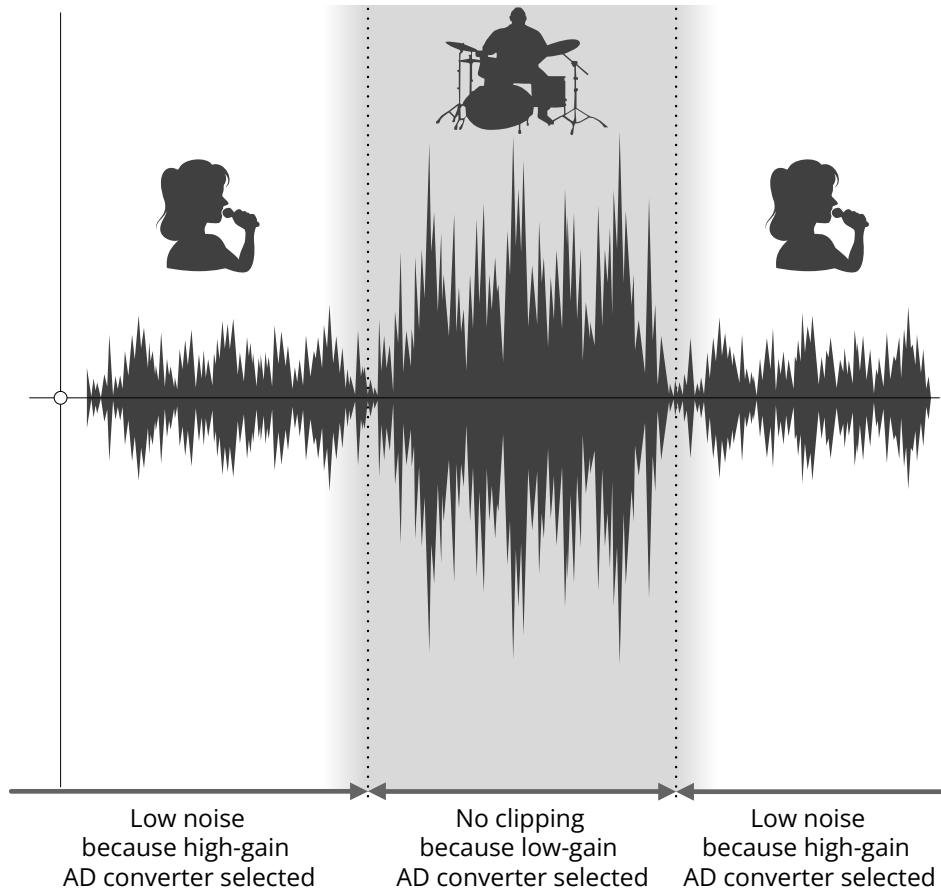



## 32-bit float WAV file overview

32-bit float WAV files have the following advantages over conventional 16/24-bit linear WAV files. These features enable the quality of the sound during recording to be maintained when editing in DAWs and other software.

### Resolution advantage

32-bit float WAV files have the advantage of being able to maintain high resolution even at low volumes. As a result, quiet sounds can be made louder when editing after recording without degrading their quality.

#### ■ 16/24-bit linear WAV

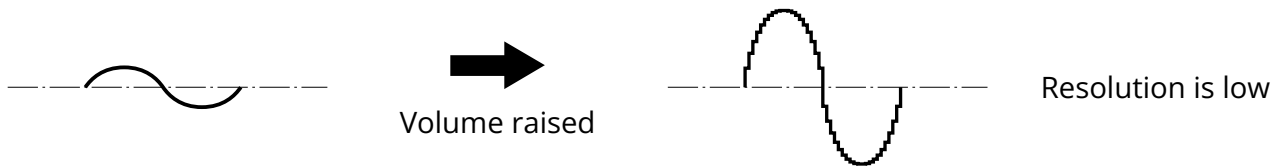

#### ■ 32-bit float WAV

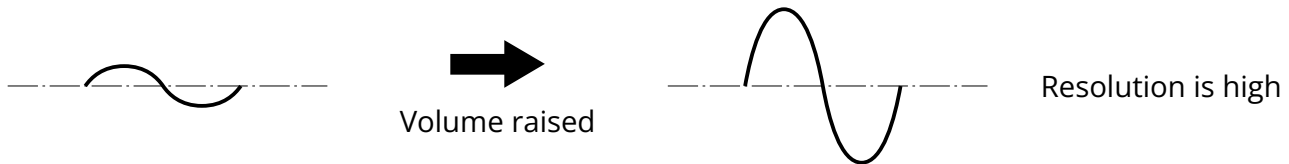

### Clipping advantage

If a waveform sounds clipped when output from the UAC-232 or in a DAW, it can be edited after recording to lower its volume and restore an unclipped waveform because the data in the 32-bit float WAV file itself is not clipped.

#### ■ 16/24-bit linear WAV

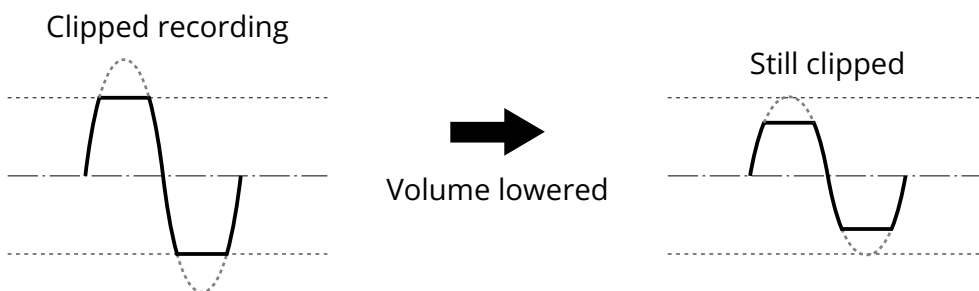

#### ■ 32-bit float WAV

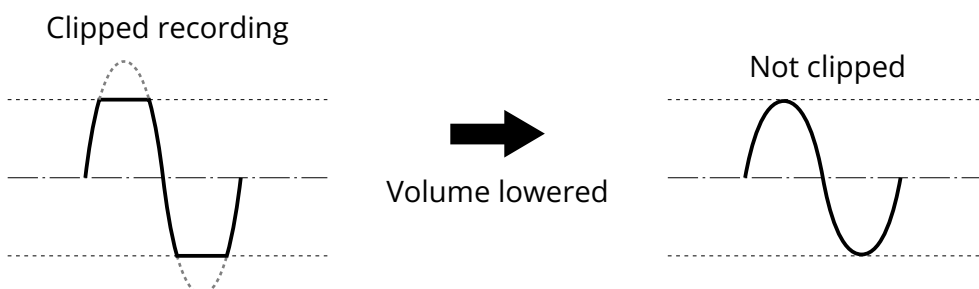

# Functions of parts

## Front

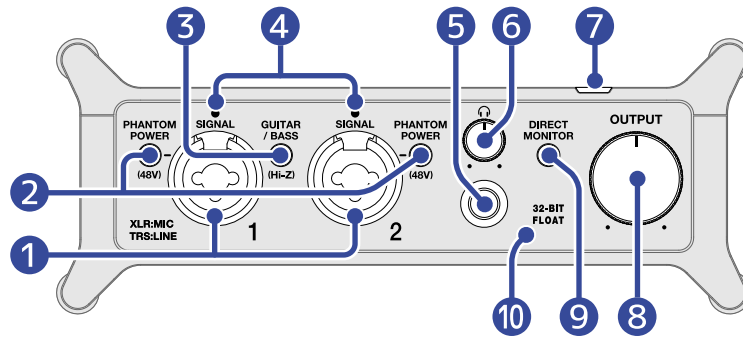

### 1 Input jacks 1-2

These input jacks have built-in mic preamps. Connect mics, keyboards, guitars and other audio sources to them. These can be used with both XLR and standard phone (balanced or unbalanced) plugs. Please use XLR plugs to connect mics and phone plugs to connect keyboards and guitars, for example. (→ [Connecting instruments and mics](#))

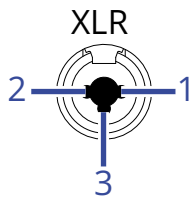

- 1: GND
- 2: HOT
- 3: COLD

### 2 PHANTOM POWER switches

These turn +48V phantom power on/off. Set this to ON when connecting condenser mics.

### 3 GUITAR/BASS switch

Use this to enable Hi-Z support for the Input jack 1 circuit. Turn this on as necessary for the connected guitar or bass.

### 4 SIGNAL indicators

These light when signals are being input.

### 5 Headphone jack

This outputs a stereo signal. Connect headphones here.

### 6 Headphone knob

Use this to adjust the headphone volume. (→ [Adjusting the headphone volume](#))

### 7 Power indicator

This lights when the power is on.

### 8 OUTPUT knob

Use this to adjust the volume of the signals output from the OUTPUT jacks. (→ [Adjusting the output volume](#))

**9** DIRECT MONITOR switch

Turn this on to directly monitor sounds from the input jacks before they pass through the computer.  
(→ [Using direct monitoring](#))

**10** 32-BIT FLOAT indicator

This lights when the UAC-232 is operating in 32-bit float mode.

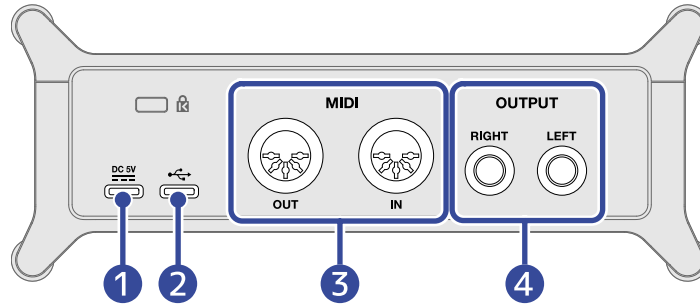

### 1 DC 5V port (Type-C)

Use this power supply USB port to connect an AC adapter or portable battery. (→ [Using an external power supply](#))

### 2 USB port (Type-C)

Use this USB port to connect with a computer or iOS/iPadOS device. (→ [Connecting to computers](#), [Connecting to iOS/iPadOS devices](#))

### 3 MIDI jacks

Use these to connect external MIDI equipment.

- OUT connector: Connect the MIDI IN connector of an external MIDI device here.
- IN connector: Connect the MIDI OUT connector of an external MIDI device here.

### 4 OUTPUT jacks

These output the left (L) and right (R) channels of a stereo signal. Connect these to speakers with built-in amplifiers, for example.

# Connecting to computers

The UAC-232 is compatible with USB bus power, so power can be supplied to it from a computer through a USB cable.

1. Install the dedicated driver before using a UAC-232 to record for the first time with a DAW application on a Windows computer. (→ [Installing the driver](#))

**NOTE:**

A driver is not necessary when using a Mac.

2. If speakers, headphones or other output devices are connected to the UAC-232, minimize their volumes. (→ [Adjusting the volume](#))

3. Use a USB cable to connect the UAC-232 USB port (Type-C) to a USB port on the computer.

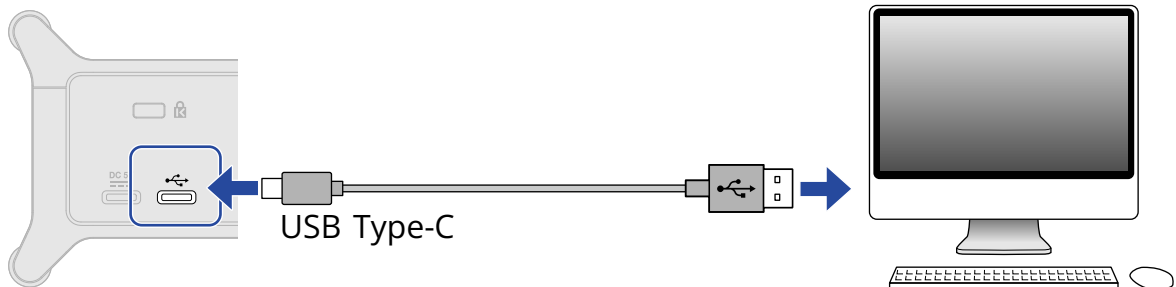

**NOTE:**

Use a USB cable that supports data transfer.

4. Confirm that the power indicator is lit.



# Preparing for use with a Mac computer

A driver is not necessary when using a Mac.

The following settings must be made to use the UAC-232 at 32-bit float with a Mac.

1. Open the Audio MIDI Setup app, which is in the Utilities subfolder of the Applications folder on the Mac.
2. Select ZOOM UAC-232 in the Audio Devices, and set the input and output formats to 32-bit float.

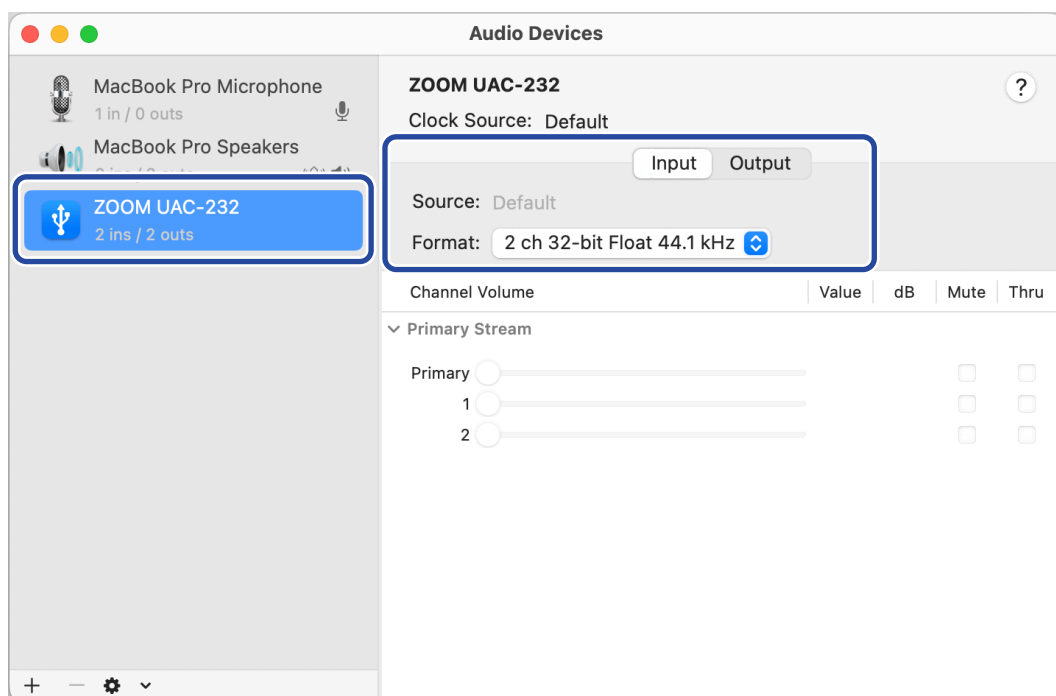

# Preparing for use with a Windows computer

## Installing the driver

---

The dedicated driver must be installed on a Windows computer before using a DAW app on it to record.

1. Download the ZOOM UAC-232 Driver from [zoomcorp.com](http://zoomcorp.com) to the computer.

**NOTE:**

The latest ZOOM UAC-232 Driver can be downloaded from the above website.

2. Launch the installer and follow the instructions to install the ZOOM UAC-232 Driver.

**NOTE:**

- Do not connect the UAC-232 to the computer during installation.
- See the Installation Guide included in the driver package for detailed installation procedures.

# Making driver control panel settings

1. Click the “ZOOM UAC-232 Control Panel” icon in the taskbar notification area to open the Control Panel.

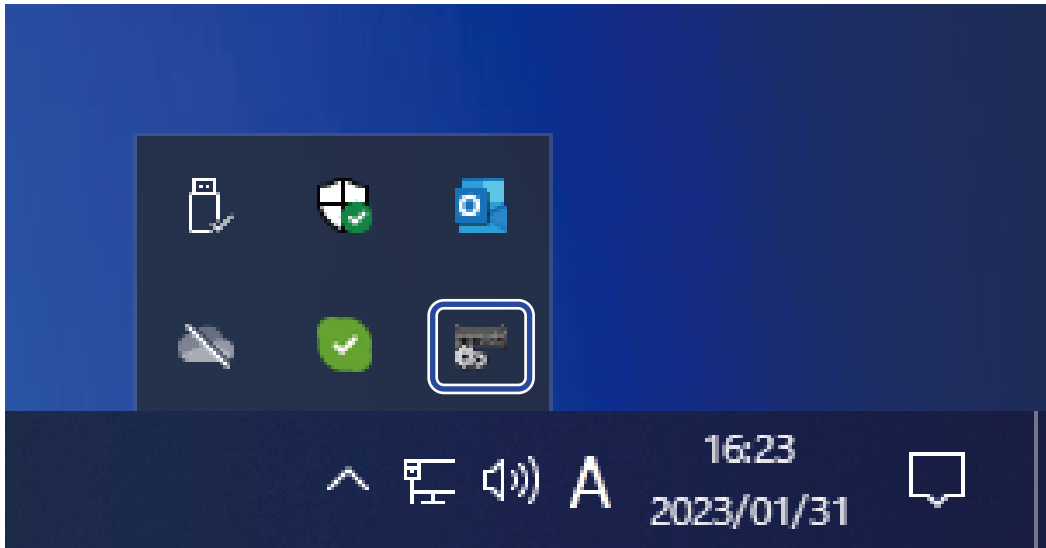

2. Make control panel settings.

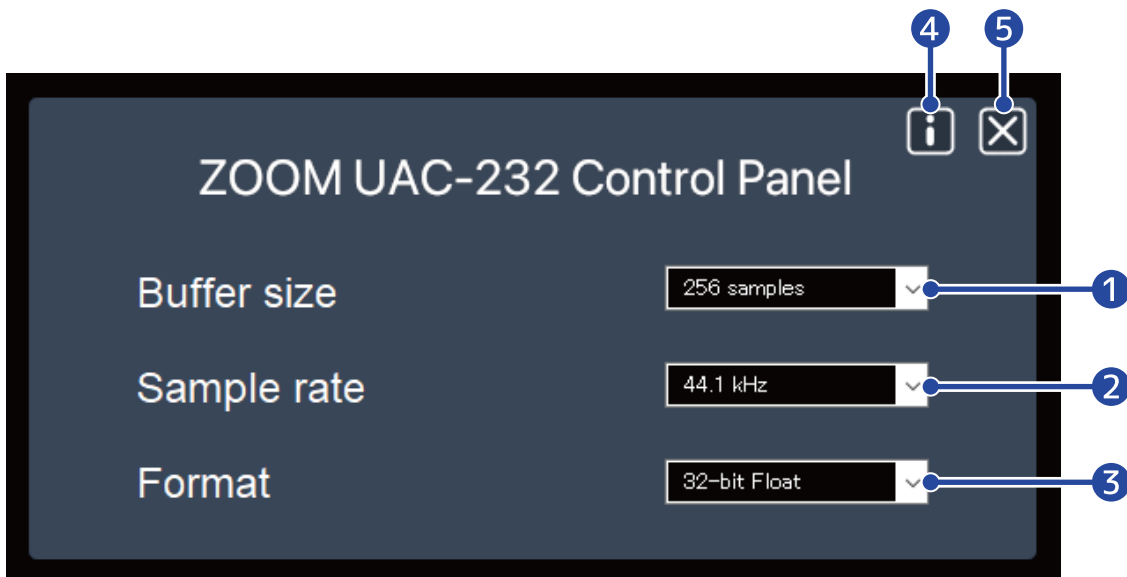

- 1 Buffer size setting**  
This sets the size of the buffer used by the driver. Raising the value makes operation more stable but also increases latency.
- 2 Sample rate setting**  
This sets the sampling frequency used by the UAC-232. If this is also set in the DAW or other application, that setting might be given priority.
- 3 Transmission format setting**  
This sets the format of data sent and received by the UAC-232.



This should normally be left set to "32-bit Float". Try "24-bit", though, if this setting does not work properly with an application.

**4** Open an information dialog

Use this to check the version, for example.

**5** Close the control panel

Use this to close the control panel.

# Connecting to iOS/iPadOS devices

An external power supply must be used during use with an iOS/iPadOS device.

1. If speakers, headphones or other output devices are connected to the UAC-232, minimize their volumes. (→ [Adjusting the volume](#))
2. Connect an external power supply. (→ [Using an external power supply](#))

**NOTE:**

Power must be provided before connecting an iOS/iPadOS device to the UAC-232.

3. Use a USB cable to connect the UAC-232 USB port (Type-C) to the iOS/iPadOS device.

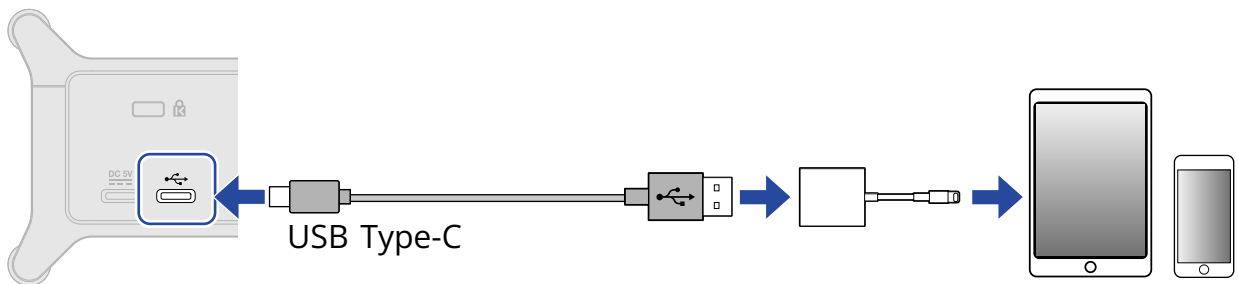

When connecting an iOS/iPadOS device, prepare USB cables and adapters that match its connectors as necessary.

Use a USB cable that supports data transfer.

Connector type	Necessary USB cable/adaptor
Lightning connector	USB Type-A to Type-C cable, Lightning to USB 3 Camera Adapter
Type-C connector	USB Type-C to Type-C cable

# Using an external power supply

---

A dedicated AC adapter (ZOOM AD-17) or a commercially-available USB portable battery can be used.

1. Connect the USB connector of the dedicated AC adapter to the DC 5V port (Type-C), and plug the AC adapter into an outlet.

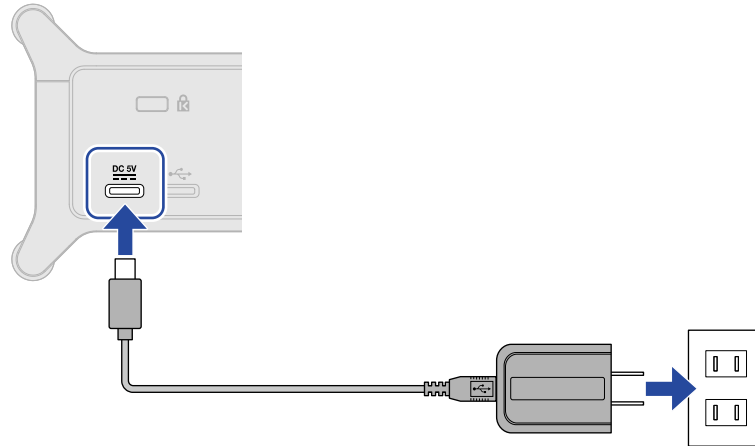

---

## HINT:



To use a USB portable battery, connect its USB cable to the DC 5V port (Type-C).

---

2. Confirm that the power indicator is lit.



# Connecting instruments and mics

Always set  and  to their minimum values and turn off  before connecting instruments and mics.

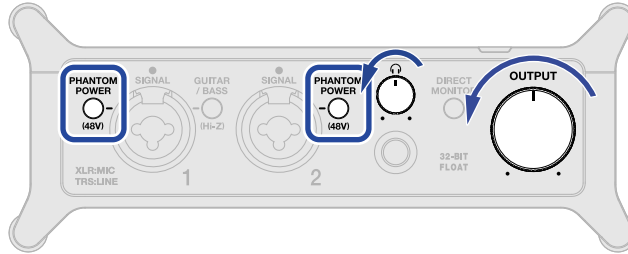

The UAC-232 adjusts the gain (amplification) of input signals according to their sources to raise them to levels that are easy to work with. The default gain amounts are as follows.

Input source	Gain
Dynamic mic (phantom power off)	+45 dB
Condenser mic (phantom power on)	+27 dB
Line (GUITAR/BASS off)	+24 dB
Guitar/bass (GUITAR/BASS on)	+18 dB

**NOTE:**

- Gain settings can be changed by using ZOOM UAC-232 Mix Control. (→ [Using ZOOM UAC-232 Mix Control](#))
- With 32-bit float recording, recording quality will not be degraded by gain settings.

# Connecting instruments

## 1. Connect an instrument to the UAC-232.

- Use an instrument cable to connect a guitar or bass, for example, to the Input 1 jack.

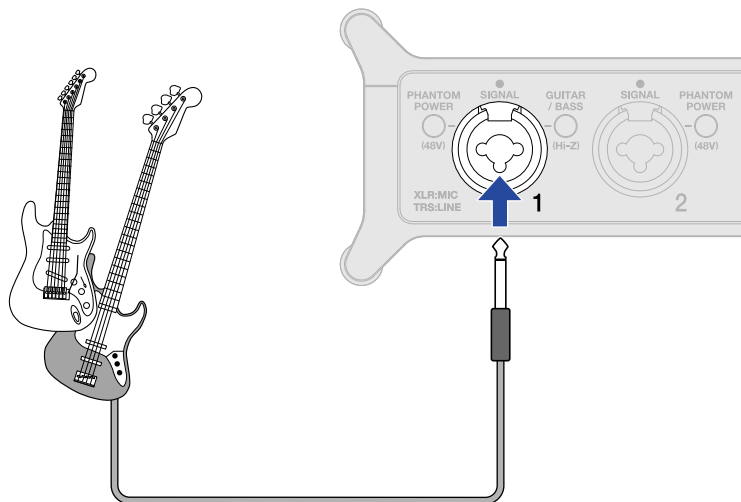

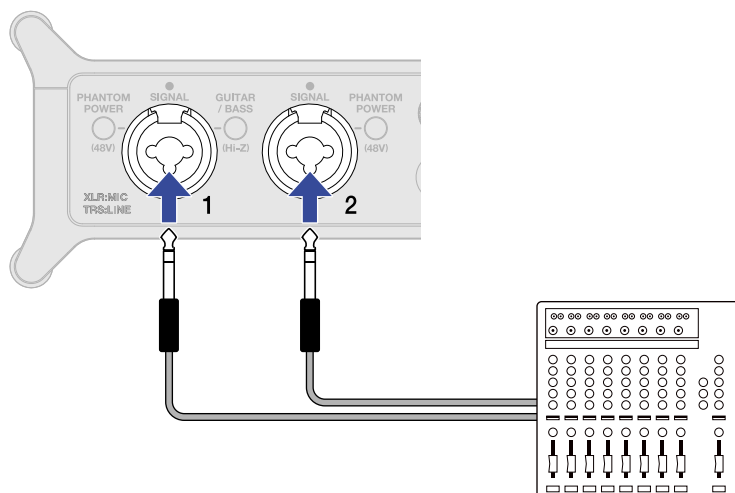
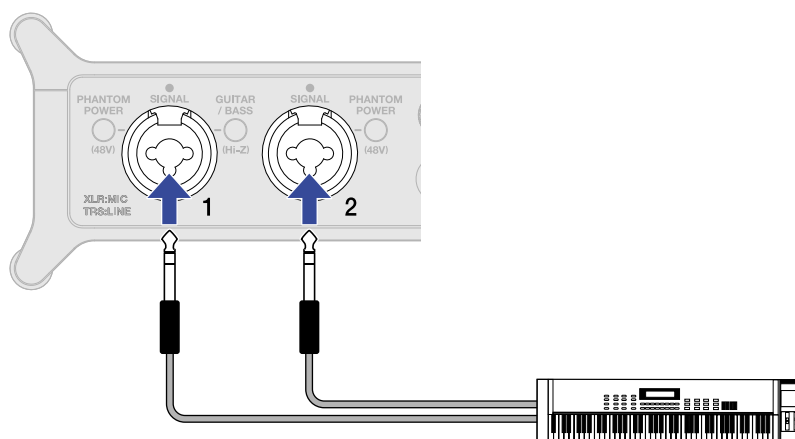

- Use instrument or TRS cables to connect a keyboard or mixer, for example, to the Input 1-2 jacks.



2. When connecting a guitar or bass guitar, press **GUITAR / BASS** so that it lights.



<b>GUITAR / BASS</b>  status	Explanation
On (lit)	Use this setting when connecting a guitar or bass. High-impedance (Hi-Z) input is supported when <b>GUITAR / BASS</b> is lit. 
Off (unlit)	Use this setting when connecting a mic or keyboard, for example.

**NOTE:**

- Please use phone plugs when connecting line-level instruments, for example.
- Phantom power (48 V) is only supplied to the XLR connectors.

# Connecting mics

1. Use mic cables to connect dynamic and condenser mics to the Input 1 and 2 jacks.

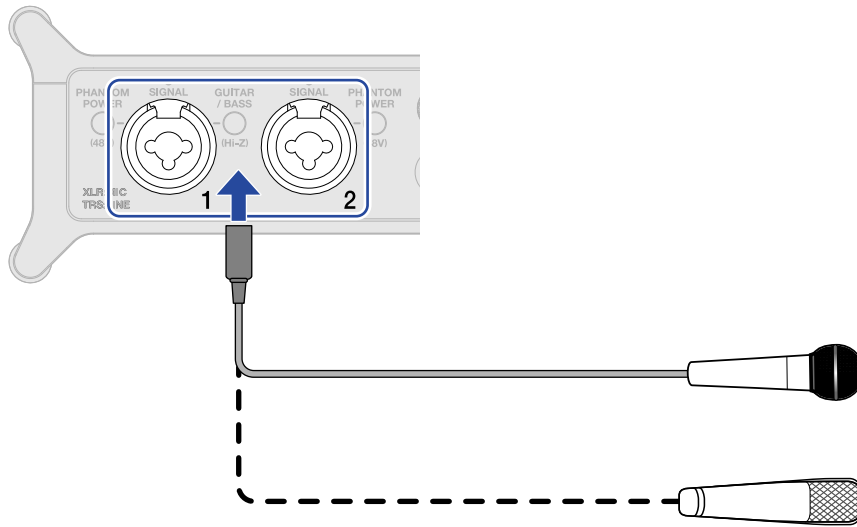

2. When connecting a mic to the Input 1 jack, if **GUITAR / BASS** is lit, press **GUITAR / BASS** to make it unlit.

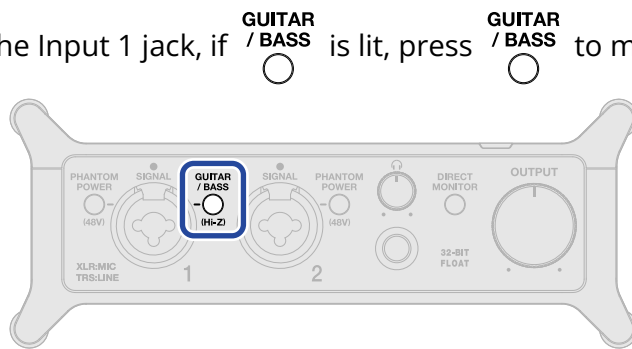

3. Press **PHANTOM POWER** so that they light when connecting condenser mics.



PHANTOM POWER status	Explanation
On (lit)	Use this to supply phantom power to condenser mics.
Off (unlit)	Use this when connecting dynamic mics.

**NOTE:**

- Please use XLR plugs when connecting mics.
- Do not turn on  when connecting equipment that is not compatible with phantom power. Doing so could damage the equipment.



# Using direct monitoring

When direct monitoring is turned on, sound input to the UAC-232 can be directly monitored using headphones, for example, before it passes through the computer. This enables monitoring without latency.

1. Press **DIRECT MONITOR** so that it lights.



---

## HINT:

The direct monitoring mix levels can be adjusted using ZOOM UAC-232 Mix Control. (→ [Using ZOOM UAC-232 Mix Control](#))

---

# Adjusting the volume

The volume output from speakers and headphones connected to the UAC-232 can be adjusted. The connected jacks have different knobs to adjust their volumes.

**NOTE:**

Minimize the UAC-232 volume before connecting speakers or headphones. Failure to do so could result in unexpected loud sounds, causing harm to hearing, for example.

## Adjusting the output volume

Turn  to adjust the volume for the OUTPUT jacks on the back of the unit.

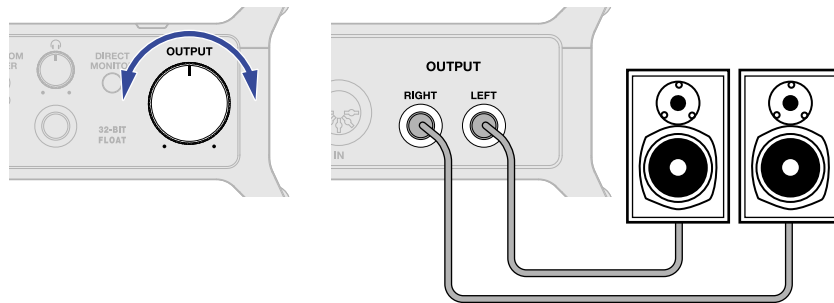

## Adjusting the headphone volume

Turn  to adjust the volume for the headphone jack on the front of the unit.

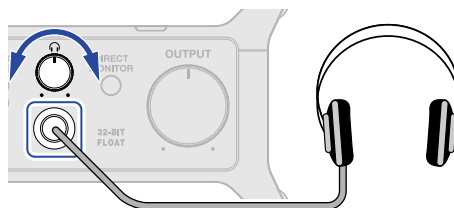

# Using ZOOM UAC-232 Mix Control

---

ZOOM UAC-232 Mix Control is an application designed to control the internal mixer settings of the UAC-232, including levels for direct monitoring and the streaming mixer.

## Installing ZOOM UAC-232 Mix Control

### Windows/Mac computers

1. Download ZOOM UAC-232 Mix Control from the ZOOM website ([zoomcorp.com](https://zoomcorp.com)).
2. Follow the instructions and install ZOOM UAC-232 Mix Control.

---

**HINT:**

- The latest version of ZOOM UAC-232 Mix Control can be downloaded from the above website.
  - Download the version of ZOOM UAC-232 Mix Control for the operating system being used.
- 

### iOS/iPadOS devices

1. Open the App Store on the iOS/iPadOS device and search for “UAC-232 Mix Control”.
2. Tap “GET” on the UAC-232 Mix Control screen.  
This will install UAC-232 Mix Control.

**NOTE:**

If a DAW or another app that uses MIDI ports is already running, the MIDI ports for ZOOM UAC-232 Mix Control will be used and proper connection might not be possible. Either launch ZOOM UAC-232 Mix Control before the other application or change the settings of that application so that it does not use MIDIIN2/MIDIOUT2 (ZOOM UAC-232 MIDI).

# ZOOM UAC-232 Mix Control Screen

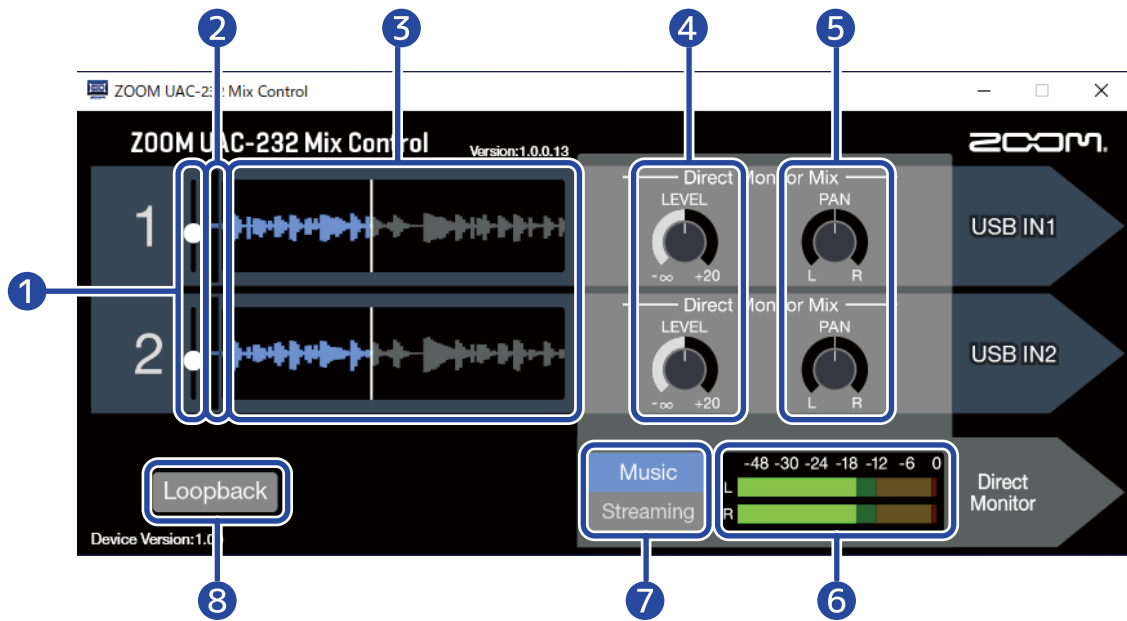

## 1 Input level sliders

Use these to adjust the input signal gain for each channel. (→ [Adjusting waveform display size](#))

## 2 Input signal levels

These show the input signal levels of each channel. (→ [Adjusting waveform display size](#))

## 3 Input signal waveforms

These show the input signal waveforms of each channel. (→ [Adjusting waveform display size](#))

## 4 LEVEL knobs

- Music mode: Use these to adjust the direct monitoring volume of each channel. (→ [Adjusting direct monitoring](#))
- Streaming mode: Use these to adjust the streaming mixer volume of each channel. (→ [Adjusting the streaming mixer](#))

## 5 PAN knobs

- Music mode: Use these to adjust the stereo positions of each channel for direct monitoring. (→ [Adjusting direct monitoring](#))
- Streaming mode: Use these to adjust the stereo positions of each channel for the streaming mixer. (→ [Adjusting the streaming mixer](#))

## 6 Level meters

- Music mode: These show the direct monitoring levels. (→ [Adjusting direct monitoring](#))
- Streaming mode: These show the streaming mixer levels. (→ [Adjusting the streaming mixer](#))

## 7 Music/Streaming switch

Use this to switch between Music and Streaming modes according to the application. (→ [Overview of Music and Streaming modes](#))

## 8 Loopback switch

This turns the loopback function on/off. (→ [Enabling the loopback function](#))

# Adjusting waveform display size

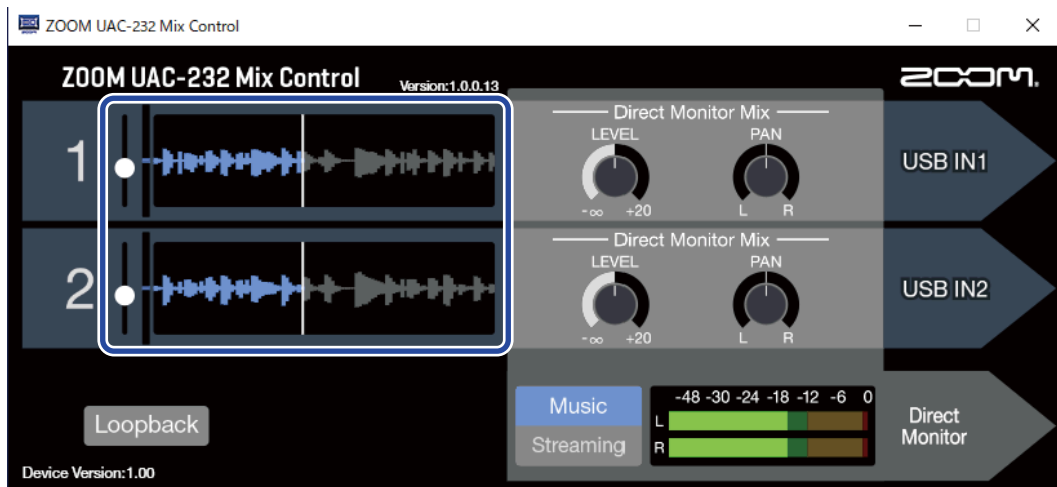

## 1. Adjust the waveform display size.

Use the input level slider for the desired channel to adjust its waveform display size so that the input signal waveform is easy to view.

### HINT:

- The sizes of the recording waveforms shown in DAW applications will be about the same size as those shown here.
- Using the input level sliders will change the amplification of the input signals, but this will not degrade recording quality.

### NOTE:

- When using a DAW app that does not support 32-bit float recording, input exceeding a certain level could cause distortion. If this occurs, the waveform size can be reduced to avoid this.
- A list of applications that have been checked for compatibility with 32-bit float recording is available on the ZOOM website ([zoomcorp.com](https://zoomcorp.com)).

# Overview of Music and Streaming modes

Set this according to the use of the USB audio signal path.



## Music mode

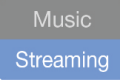

The Music mode setting is good for making music with a DAW, for example.

Set  to Music in ZOOM UAC-232 Mix Control. (Music mode is enabled when the unit is first used after purchase or initialization.)

This mode is useful for recording a guitar and vocals simultaneously to separate tracks, for example. Input sounds are handled as separate signals by the computer or iOS/iPadOS device in the same way as with an ordinary audio interface.

In this mode,  and  can be used to adjust the direct monitoring mix. (→ [Adjusting direct monitoring](#))

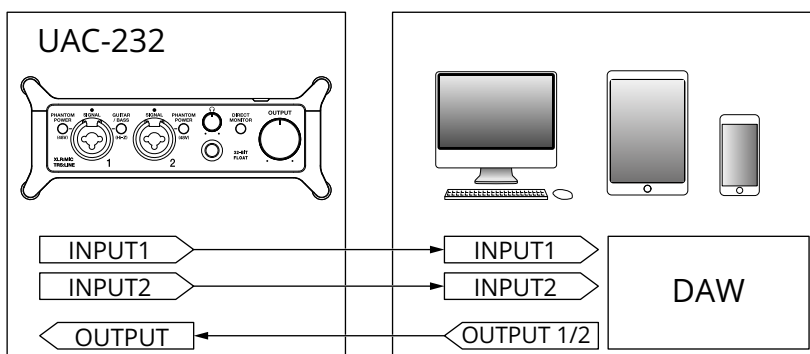

→ [Use example: Making music](#)

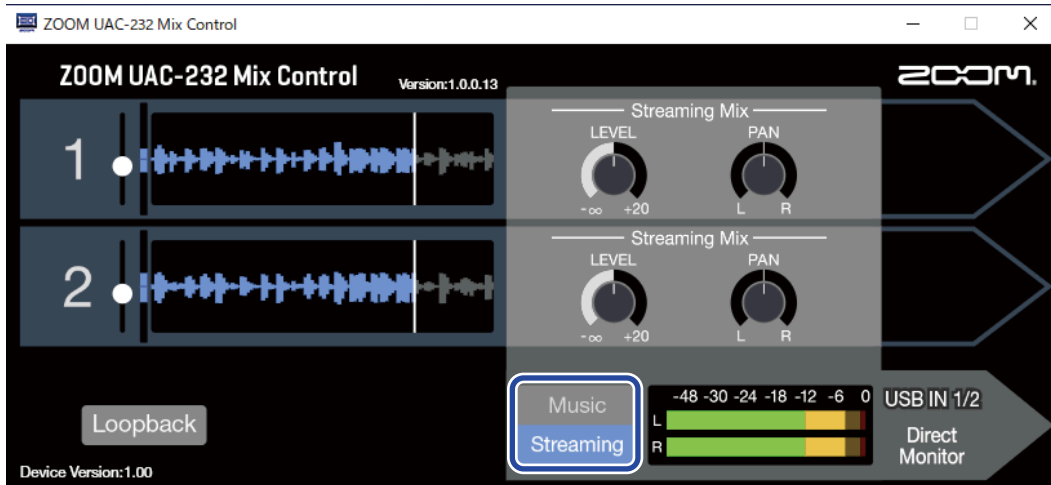

# Streaming mode



The Streaming mode setting is good for web streaming.

Set  Music to Streaming in ZOOM UAC-232 Mix Control.

This mode is useful for streaming solo performances of vocals accompanied by guitar, for example. Input sounds can be mixed like using an audio mixer and then sent to the computer or iOS/iPadOS device.

In this mode,  and  can be used to adjust the streaming mixer levels. (→ [Adjusting the streaming mixer](#))

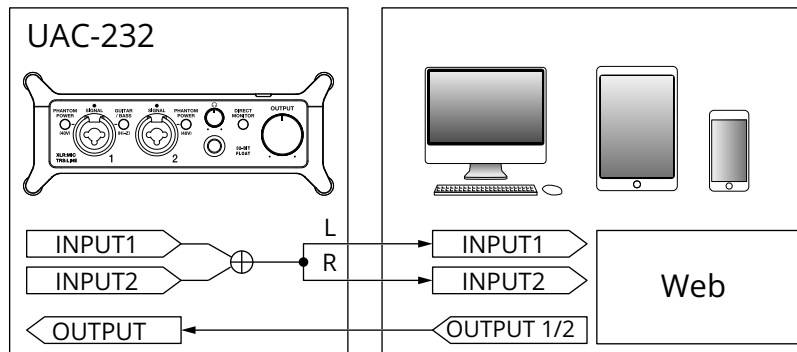

→ [Use example: Web streaming using a computer](#)

→ [Use example: Web streaming using an iOS/iPadOS device](#)



# Adjusting direct monitoring

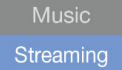

## 1. Enable Music mode.

Press  to enable Music mode.

## 2. Adjust direct monitoring levels.

Turn  to adjust the levels of each channel.

If levels are raised too high using , the output sound could be clipped. Adjust them so that the level indicators do not light red.

## 3. Set stereo positions for direct monitoring.

Turn  to adjust the stereo positions of each channel.

# Adjusting the streaming mixer

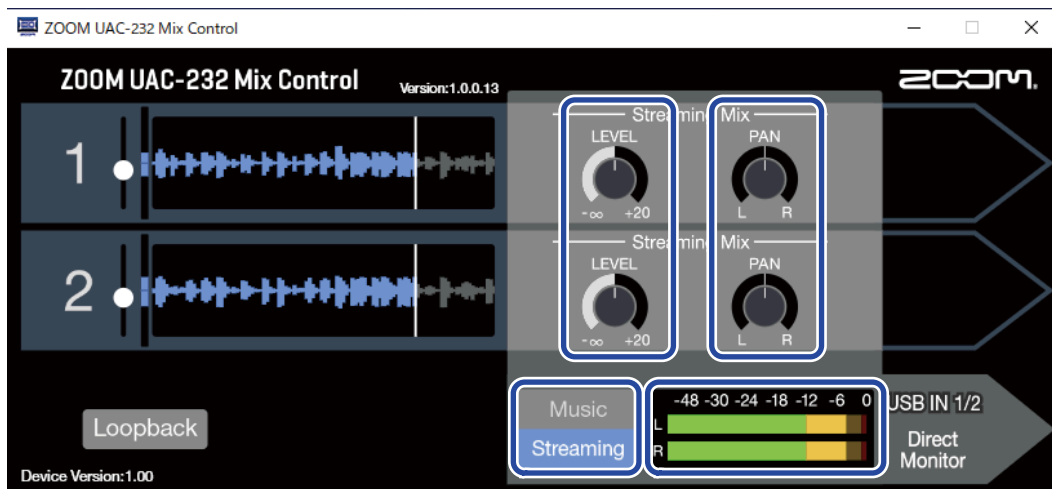

## 1. Enable Streaming mode.

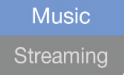
Press  to enable Streaming mode.

## 2. Adjust streaming mixer levels.

Turn  to adjust the levels of each channel.

If levels are raised too high using , the streamed sound could be clipped. Adjust them so that the level indicators do not light red.

## 3. Set stereo positions for the streaming mixer.

Turn  to adjust the stereo positions of each channel.

---

### HINT:

When in Streaming mode, turn on  to enable monitoring the mix levels of the streaming mixer.

---

# Enabling the loopback function

By turning on the Loopback function, sound input through the UAC-232 Input 1–2 jacks and sound output from the computer can be mixed and then input to the computer again (looped back).

This is convenient for mixing background music played on the computer with sound input through the UAC-232 and streaming it live, for example.

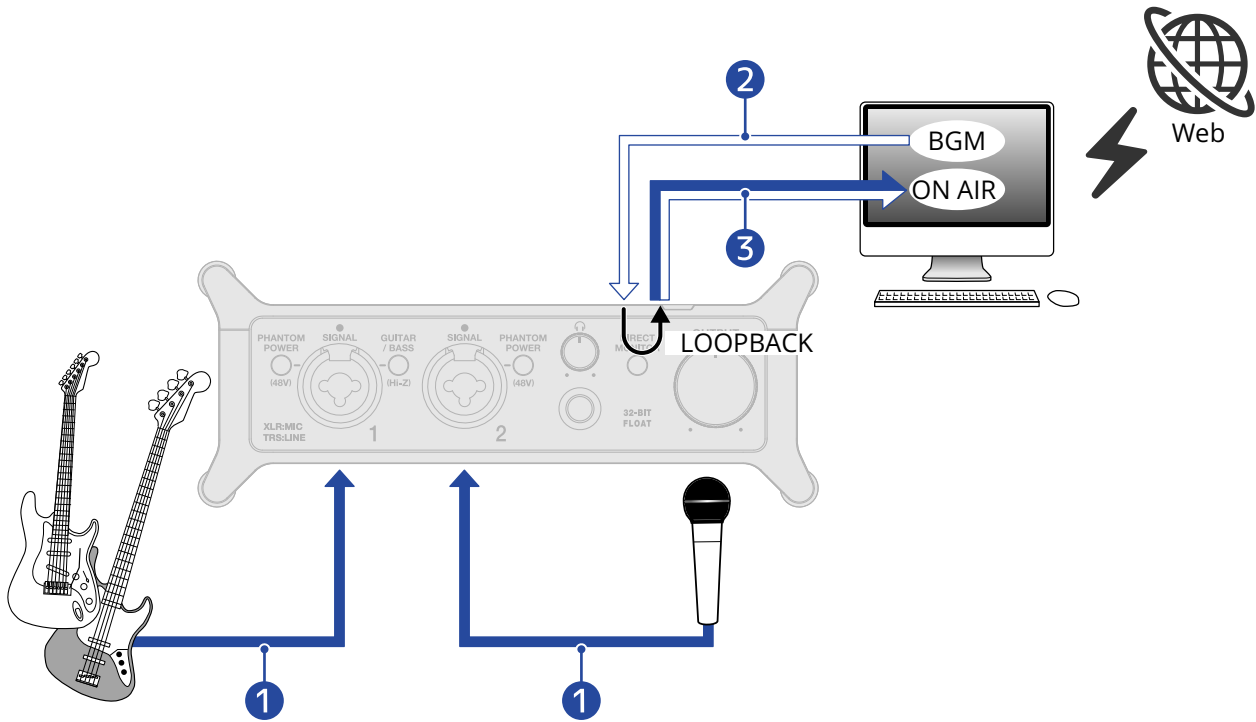

- 1 Mic and instrument sounds are input to the UAC-232.
- 2 BGM from the computer is input to the UAC-232.
- 3 Mic and instrument sounds and the BGM from the computer are mixed and output to the computer.

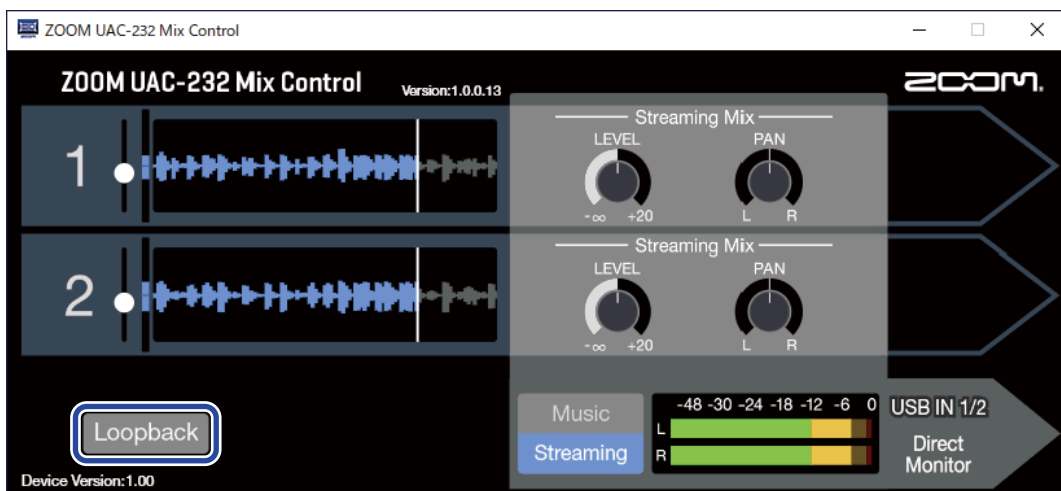

1. Enable **Loopback** in ZOOM UAC-232 Mix Control.

**NOTE:**

When the UAC-232 loopback function is enabled, disable monitoring of the UAC-232 in the DAW or streaming application.

If enabled, a feedback loop could be generated, which might cause loud noise to be output.

# Restoring factory default settings

This will restore the settings of the UAC-232 switches and internal mixer to their factory default values.

1. While pressing **PHANTOM POWER** for Input jack 1, connect a USB cable to power the unit.
2. Initialize the settings.

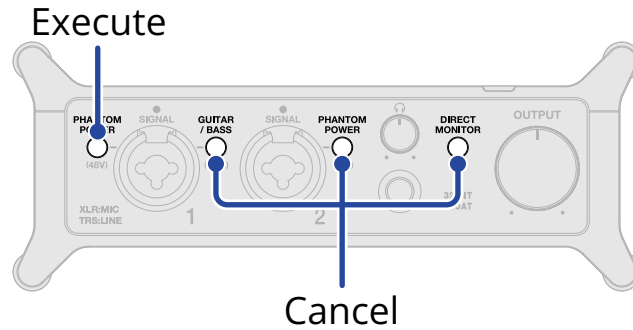

Execute	Press <b>PHANTOM POWER</b> for Input jack 1. <b>PHANTOM POWER</b> for Input jack 1 will blink and initialization will start.
Cancel	Press <b>GUITAR / BASS</b> , <b>DIRECT MONITOR</b> or <b>PHANTOM POWER</b> for Input jack 2.

# Managing the firmware

---

## Checking the firmware version

The firmware version used by the UAC-232 can be checked. The ZOOM UAC-232 Mix Control application is necessary to check the firmware version. (→ [Using ZOOM UAC-232 Mix Control](#))

## Updating the firmware

The UAC-232 firmware can be updated to the latest version. Files for the latest firmware updates can be downloaded from the ZOOM website ([zoomcorp.com](http://zoomcorp.com)).

Follow the instructions in the “UAC-232 Firmware Update Guide” on the UAC-232 download page.

# Use example: Making music

To make music using a DAW app to record guitar and vocals at the same time, for example, use the UAC-232 in Music mode. (Music mode is enabled when the unit is first used after purchase or initialization.) The audio from the guitar and vocals can be recorded to separate tracks.

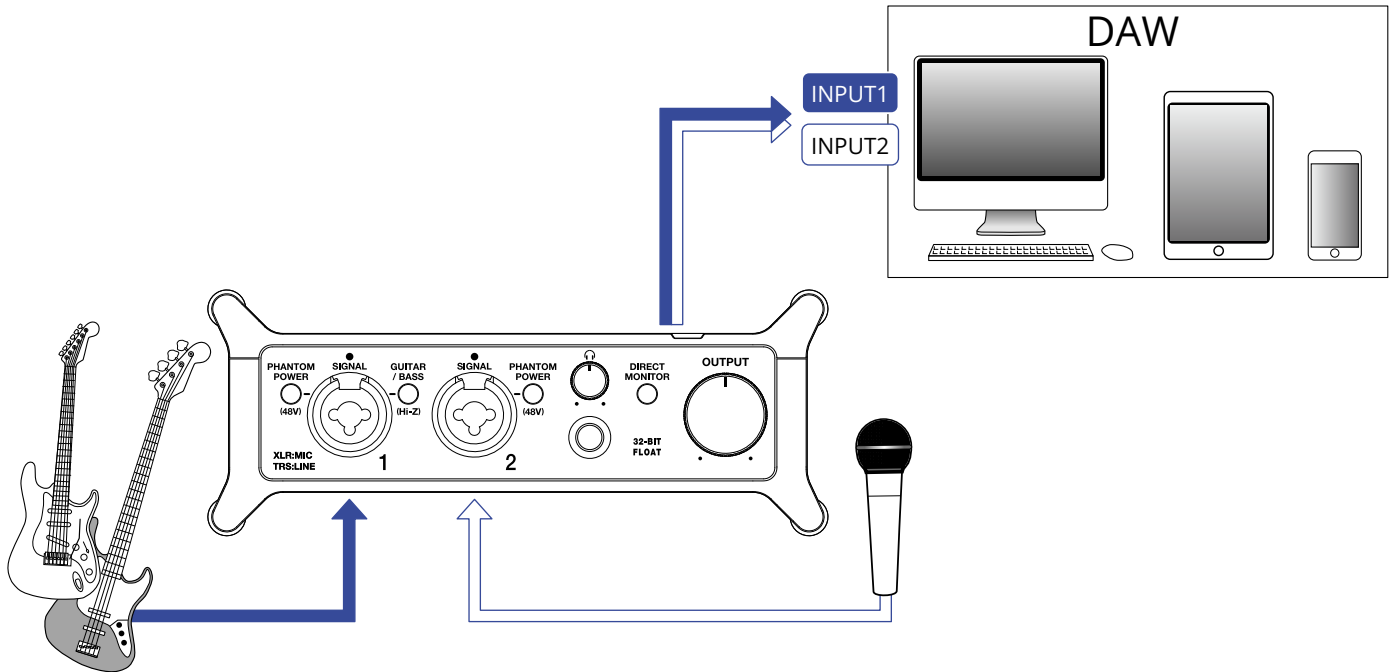

1. Set Music to Music mode in ZOOM UAC-232 Mix Control. (→ [Music mode](#))



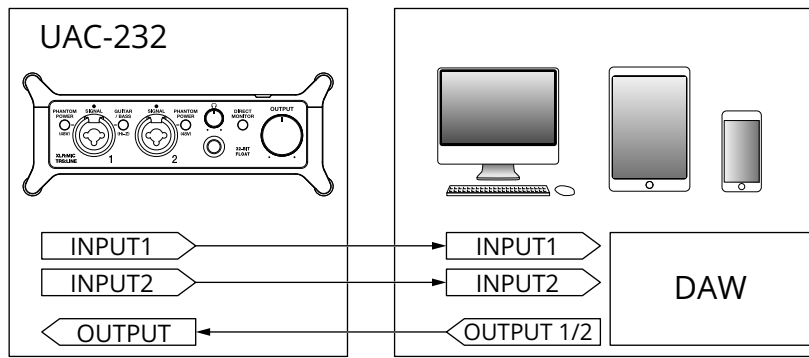

**2.** Supply power if using an iOS/iPadOS device. (→ [Using an external power supply](#))

**NOTE:**

Power must be provided before connecting an iOS/iPadOS device to the UAC-232.

**3.** Connect the UAC-232 and the computer or iOS/iPadOS device. (→ [Connecting to computers](#), [Connecting to iOS/iPadOS devices](#))

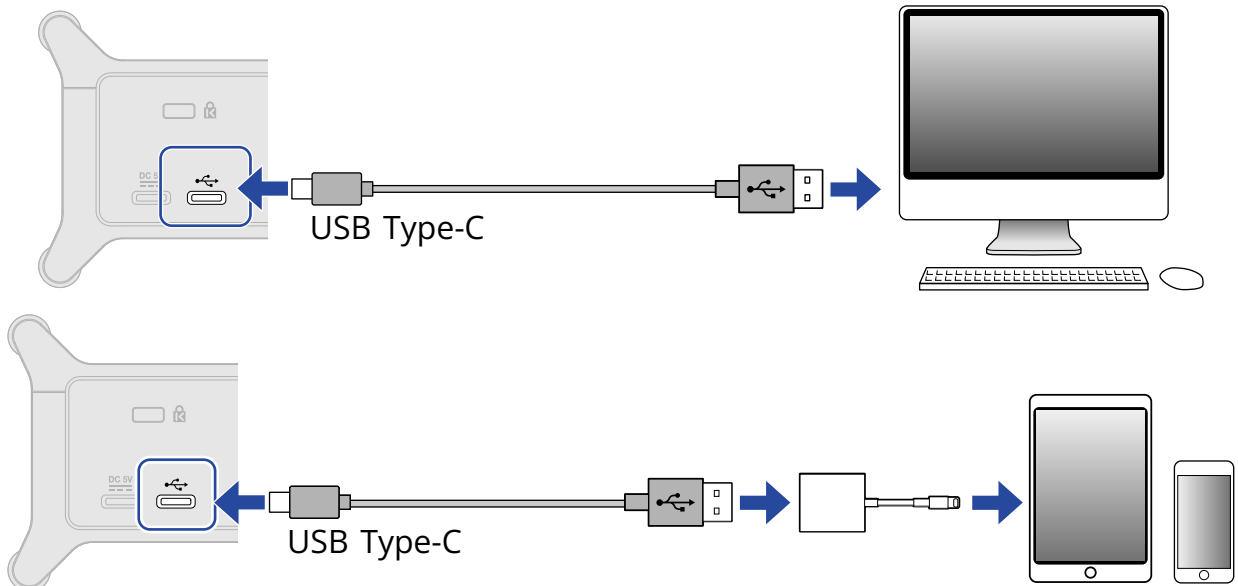

**4.** Connect the mic and instrument and set the switches. (→ [Connecting instruments](#), [Connecting mics](#))



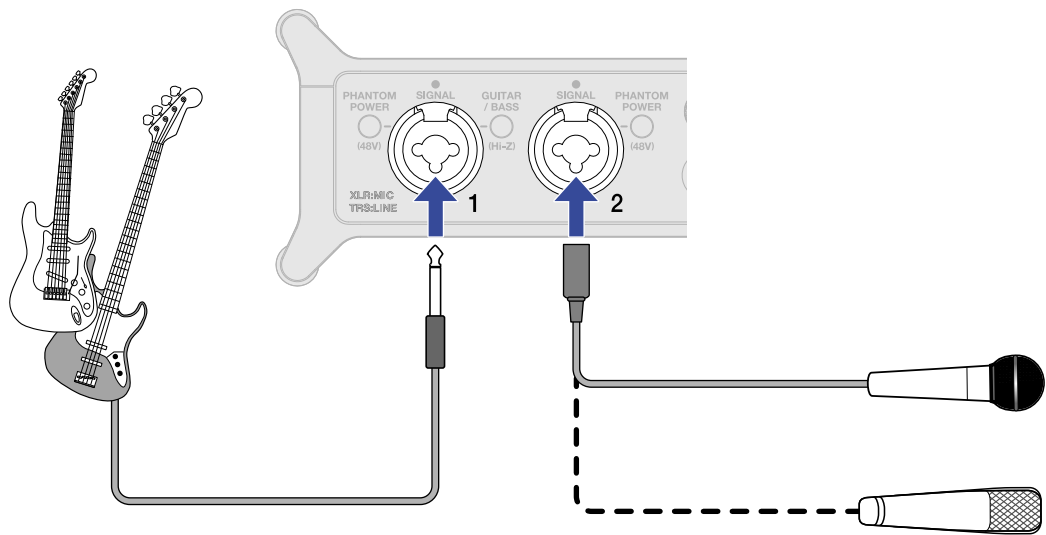

5. Turn **OUTPUT** and  to adjust the output volume. (→ [Adjusting the volume](#))

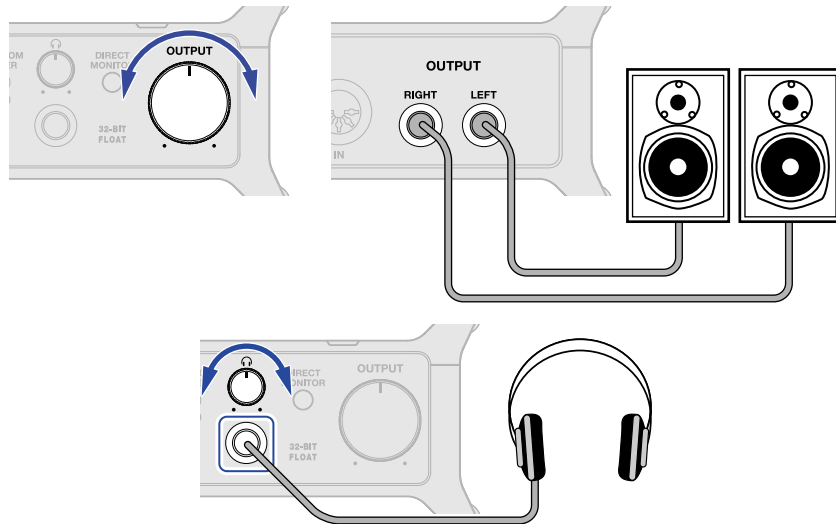

6. Launch the DAW app on the computer or iOS/iPadOS device and select the UAC-232 as the audio device.

7. Create a 32-bit float project and start recording.

**NOTE:**

Refer to the DAW app manual for how to use it.

# Use example: Web streaming using a computer

When connecting with a computer for web streaming, set the UAC-232 to Streaming mode. Using the ZOOM UAC-232 Mix Control app is necessary to switch the UAC-232 to Streaming mode. (→ [Using ZOOM UAC-232 Mix Control](#))

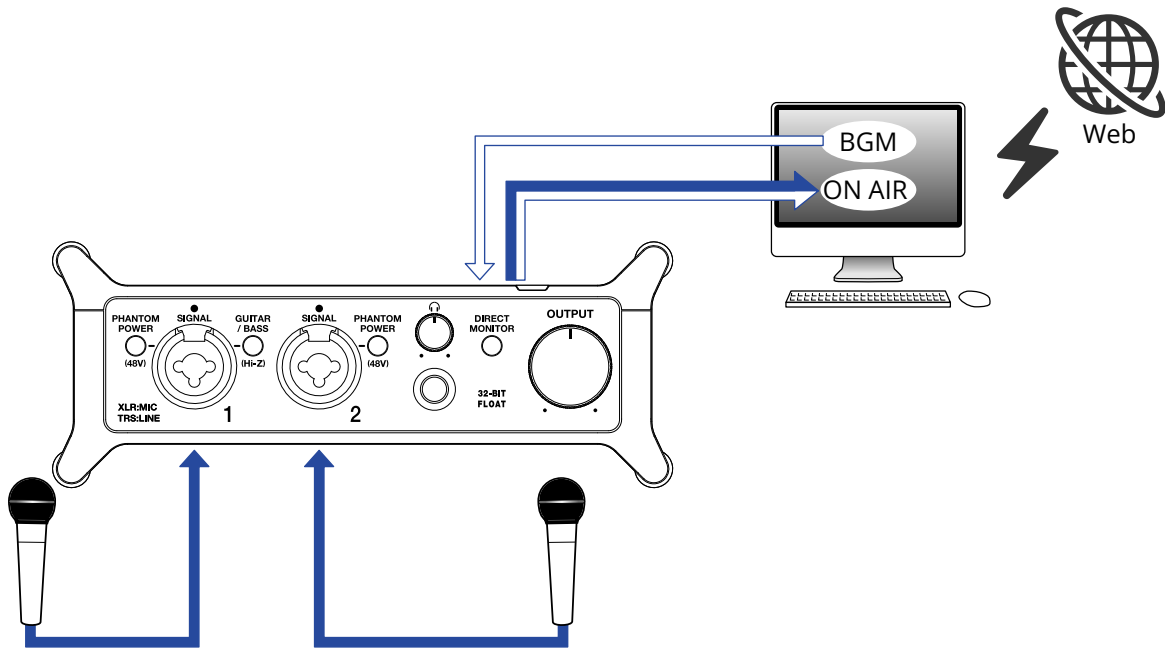

1. Set **Music Streaming** to Streaming mode in ZOOM UAC-232 Mix Control. (→ [Streaming mode](#))



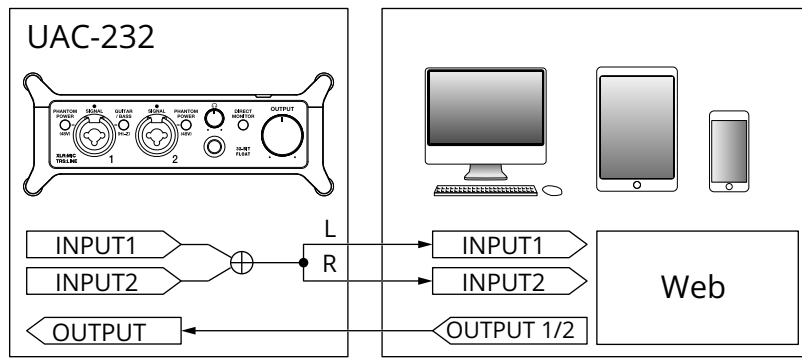

**2.** Connect the UAC-232 and the computer. (→ [Connecting to computers](#))

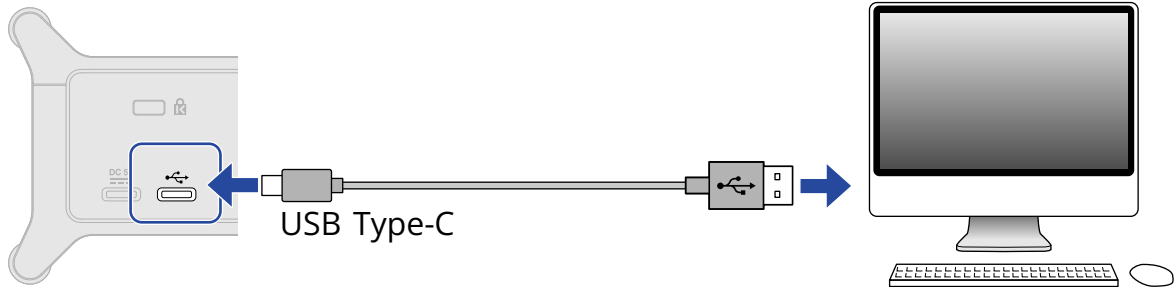

**3.** Connect the mic and instrument and set the switches. (→ [Connecting instruments](#), [Connecting mics](#))

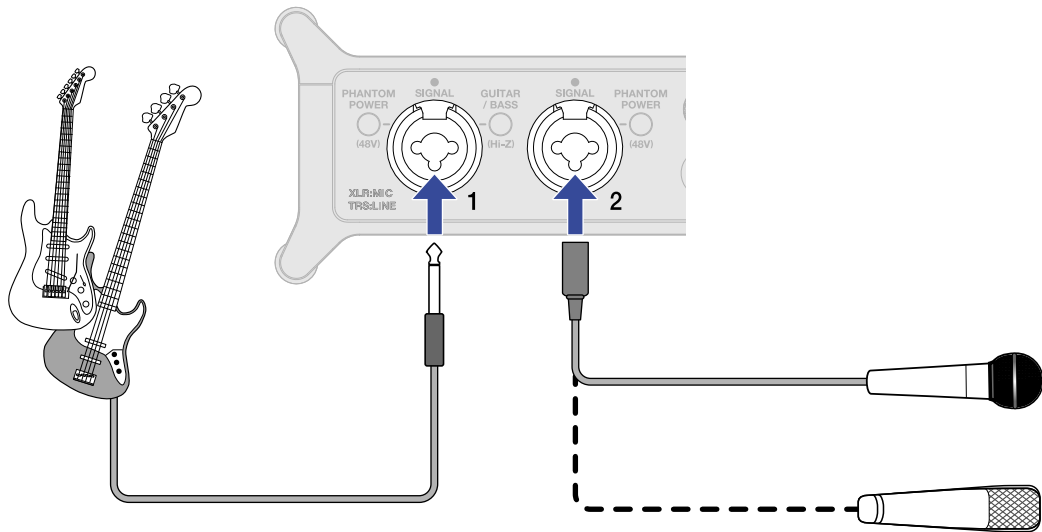

4. Select the UAC-232 as the computer input and output device.
5. To enable the loopback function for sound from the computer, press the **Loopback** switch in ZOOM UAC-232 Mix Control to light it. (→ [Enabling the loopback function](#))

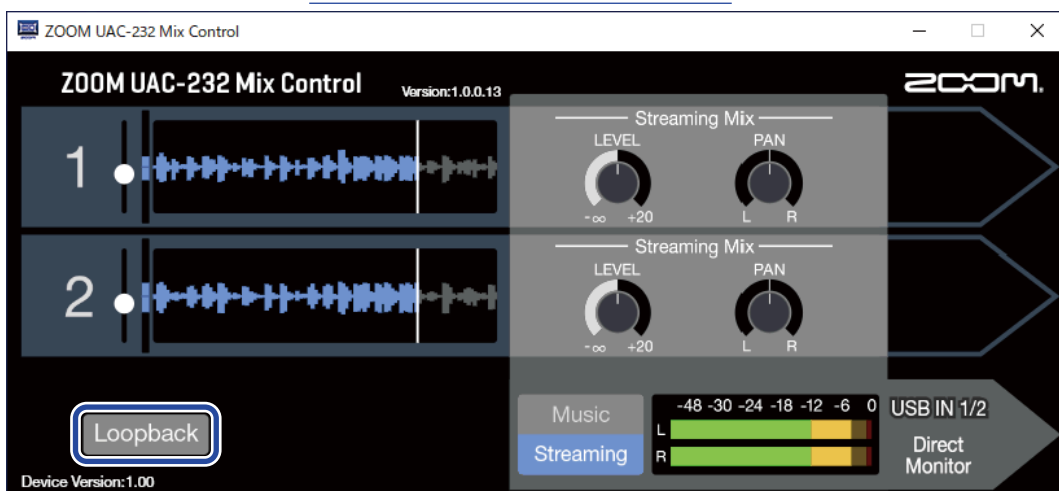

6. Turn **OUTPUT** and  to adjust the output volume. (→ [Adjusting the volume](#))

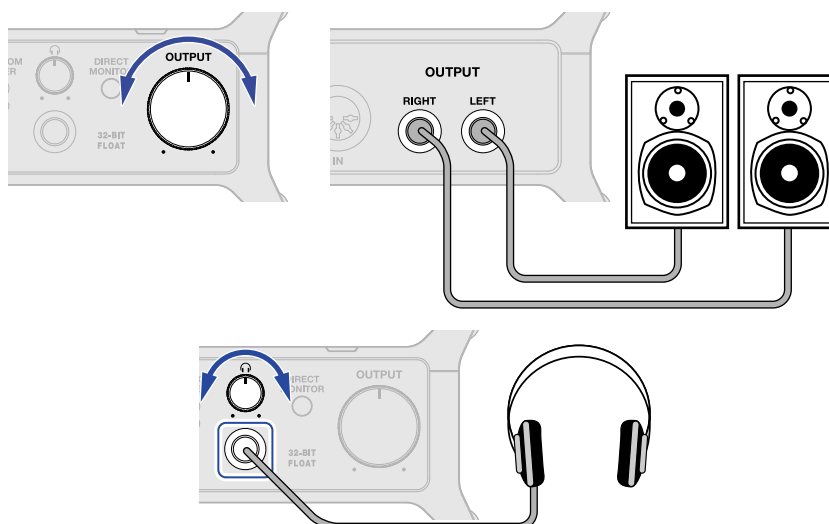

7. Launch the streaming app on the computer, and select the UAC-232 as the “audio” or “input/output” device.
8. Start streaming.

**NOTE:**

- Use BGM with permission from its creators.
- Refer to the streaming app manual for how to use it.

# Use example: Web streaming using an iOS/iPadOS device

When using an iOS/iPadOS device for web streaming, switch the UAC-232 to Streaming mode.

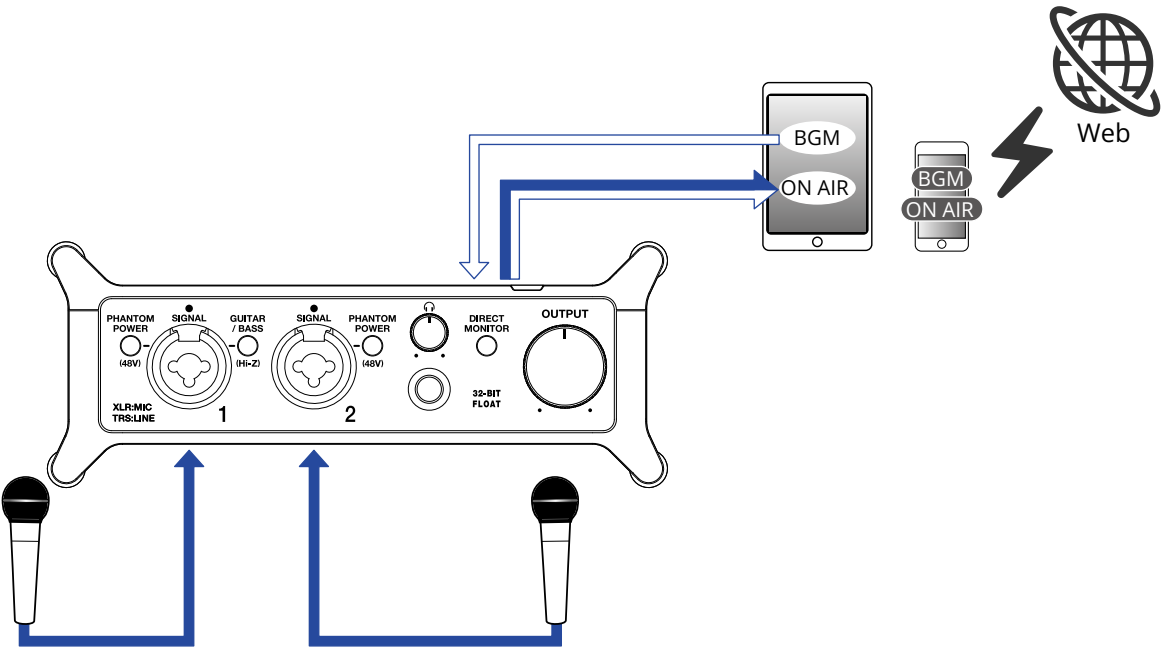

1. Set Music to Streaming mode in ZOOM UAC-232 Mix Control. (→ [Streaming mode](#))



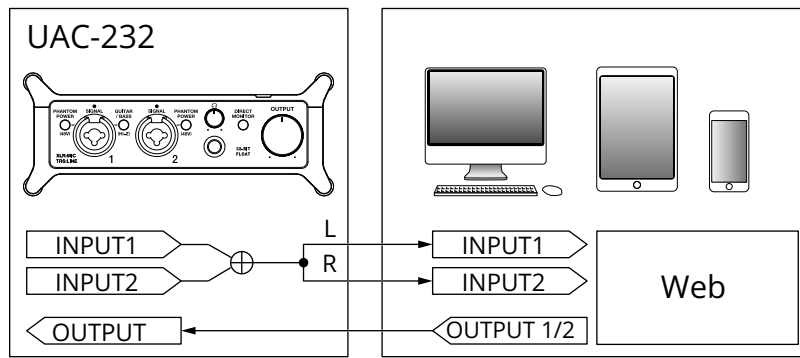

**2.** Supply power. (→ [Using an external power supply](#))

**NOTE:**

Power must be provided before connecting an iOS/iPadOS device to the UAC-232.

**3.** Connect the UAC-232 and the iOS/iPadOS device. (→ [Connecting to iOS/iPadOS devices](#))

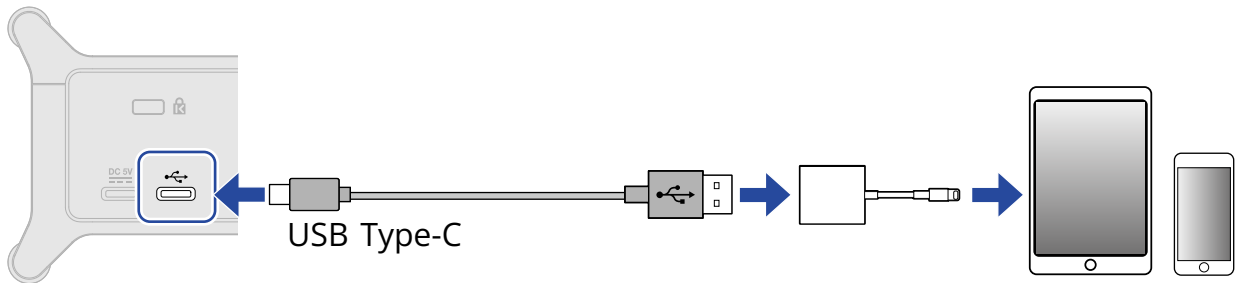

**4.** Connect the mic and instrument and set the switches. (→ [Connecting instruments](#), [Connecting mics](#))

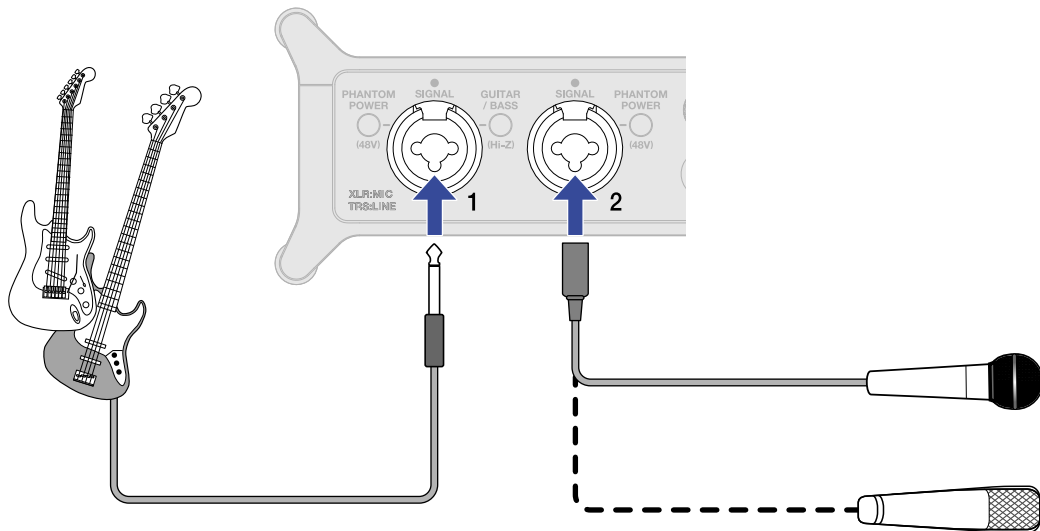

5. Turn **OUTPUT** and  to adjust the output volume. (→ [Adjusting the volume](#))

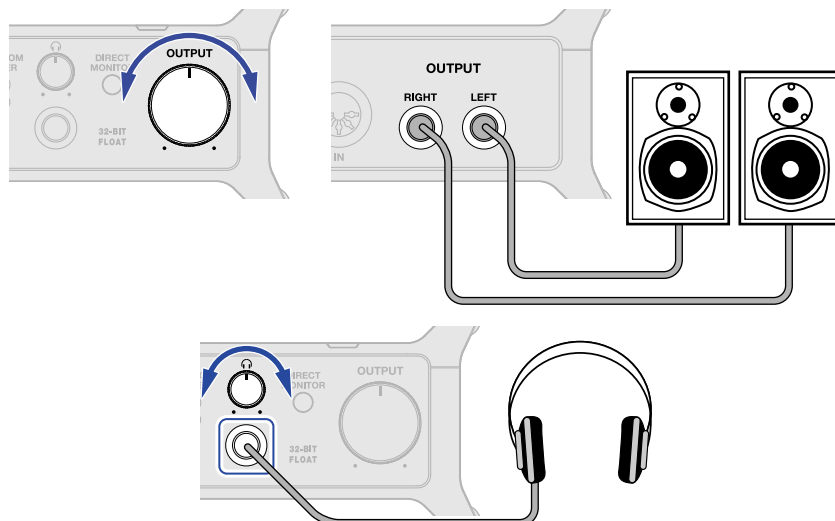

6. Launch the streaming app on the iOS/iPadOS device and start streaming.

**NOTE:**

Refer to the streaming app manual for how to use it.

# Using the included flat cable fasteners

---

The included flat cable fasteners are useful for attaching cables to the handles on the sides, for example.

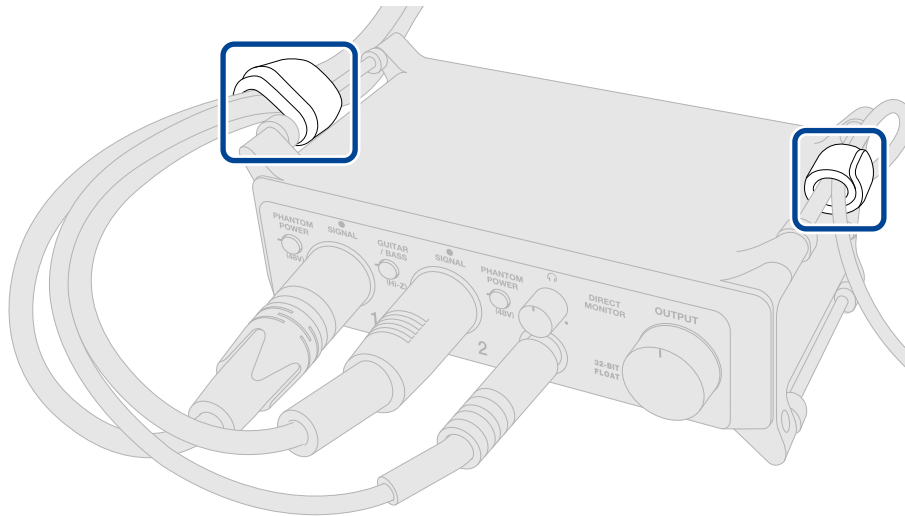

In addition, they can be used to hold the interface in place or to attach it to a mic stand.



# Mixer diagram

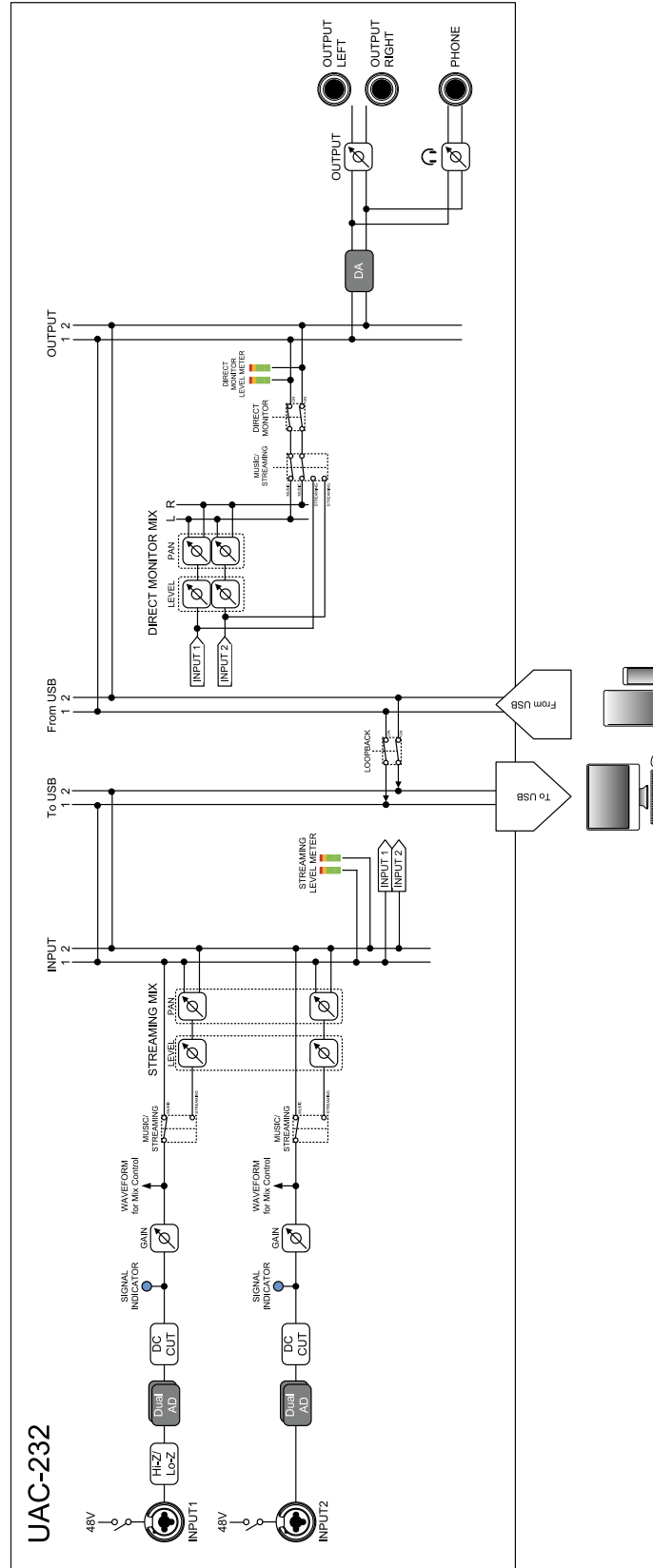

# Terms used in this manual

---

## USB audio interface

This is equipment that can input sound from mics and instruments, for example, to a computer or iOS/iPadOS device and output sound from that device to speakers and headphones.

## Dynamic mic

These mics do not require phantom power and are tough and durable.

## Condenser mic

These mics usually have high sensitivity and can capture sound with high quality. These require phantom power supply for use.

## Phantom power (48 V)

This is a function that supplies power to devices that require an external power supply, including some condenser mics.

+48 V is standard.

# Troubleshooting





## Not recognized by computer when connected

- Use a USB cable that supports data transfer.
- Confirm that the USB cable is connected to the standard USB port on the UAC-232 and not to the DC 5V port.

## Cannot select or use the UAC-232 device

- Confirm that the UAC-232 has been connected correctly to the computer. (→ [Connecting to computers](#))
- Quit all software that is using the UAC-232. Then, disconnect and reconnect the USB cable connected to the UAC-232.
- If using a USB hub, stop using it. Connect the UAC-232 directly to a USB port on the computer.
- When connecting to a Windows computer, installing the dedicated driver could resolve problems with applications other than DAWs. (→ [Installing the driver](#))
- Reinstall the dedicated driver.

## The sound of the device connected to the input jack is distorted, too quiet or silent

- When using a condenser mic, turn on  .
- Use  or  to adjust the volume.
- Use ZOOM UAC-232 Mix Control to adjust the waveform display size.
- If the level meters in ZOOM UAC-232 Mix Control lights red, use  to make adjustments.

## Cannot play or record

- Confirm that “ZOOM UAC-232” is selected in the “Sound” settings of the computer being used.
- Confirm that UAC-232 is set for input and output in the software being used.
- Quit all software that is using the UAC-232. Then, disconnect and reconnect the USB cable connected to the UAC-232.

## Playback sound cannot be heard or is quiet

- Check the connections and volume settings of the speakers.

- Use  or  to adjust the volume.

## Cannot be used with an iOS/iPadOS device

- Confirm that the external power supply is connected correctly. (→ [Using an external power supply](#))

## Sound breaks up during playback or recording

- If the audio buffer size of the software being used can be adjusted, increase it.
- Turn off the automatic sleep function and other computer power saving settings.
- If using a USB hub, stop using it. Connect the UAC-232 directly to a USB port on the computer.
- We provide methods to optimize Windows computer settings for music production on our website ([zoomcorp.com](http://zoomcorp.com)). Try using the settings provided there.

## Noise is loud during direct monitoring

- Use  to minimize channels that do not have connected inputs.

# Specifications

Input and output channels	Number of input channels	Mono (MIC/LINE)	2
	Number of output channels	Stereo (TRS)	1
		Stereo (headphone)	1
Connectors	Inputs 1-2	Type	XLR/TRS combo jack (XLR: 2 HOT/TRS: TIP HOT)
		Input impedance	XLR: 2.7 k $\Omega$ TRS: 4 k $\Omega$ /1 M $\Omega$ (when Hi-Z on)
		Maximum input level	XLR: +6 dBu TRS: +24 dBu / +11.5 dBu (when Hi-Z on)
		Phantom power	+48 V
	Outputs	Type	TRS phone jacks (balanced)
		Maximum output level	+18 dBu (at 0 dBFS)
		Output impedance	100 $\Omega$
	Headphones	Type	Standard stereo phone jack 100 mW + 100 mW (32 $\Omega$ load)
		Output impedance	12 $\Omega$
		MIDI	IN/OUT (5-pin DIN connectors)
	USB	USB Type-C (audio interface function) • Use a USB cable that supports data transfer. USB bus power is supported.	
	DC 5V	USB Type-C (for power supply)	
Frequency response	Inputs	44.1 kHz: 20 Hz – 20 kHz, +0.1 dB / -0.2 dB 192 kHz: 20 Hz – 80 kHz, +0.1 dB / -0.2 dB	
	Outputs	44.1 kHz: 20 Hz – 20 kHz, +0.0 dB / -0.1 dB 192 kHz: 20 Hz – 80 kHz, +0.0 dB / -1.0 dB	

	Headphones	44.1 kHz: 20 Hz – 20 kHz, +0.0 dB / –0.5 dB 192 kHz: 20 Hz – 80 kHz, +0.0 dB / –1.0 dB
	Equivalent input noise	–127 dBu or less (IHF-A)
Audio interface	Input and output channels	Recording: 2 channels Playback: 2 channels
	Sampling frequencies	44.1 kHz, 48 kHz, 88.2 kHz, 96 kHz, 176.4 kHz, 192 kHz
	Bit depth	32-bit float / 24-bit
	Interface	USB 2.0
	Class	USB Audio Class 2.0
Power		AC adapter (ZOOM AD-17): DC 5 V/1 A • USB bus power is supported.
	Rated current	USB / AC adapter (5 V): 293 mA
	Power consumption	5 W maximum
	Dimensions	164 mm (W) × 105.5 mm (D) × 65 mm (H)
	Weight (unit only)	355 g

Note: 0 dBu = 0.775 Vrms



ZOOM CORPORATION

4-4-3 Kanda-surugadai, Chiyoda-ku, Tokyo 101-0062 Japan

[zoomcorp.com](https://zoomcorp.com)