



**KONTAKT 8**

**2**

# Table of Contents

<b>1. Disclaimer</b> .....	<b>1</b>
<b>2. Welcome to Kontakt</b> .....	<b>2</b>
Document conventions .....	3
Further resources .....	3
<b>3. About Kontakt</b> .....	<b>4</b>
<b>4. New in Kontakt 8</b> .....	<b>5</b>
<b>5. Installation and setup</b> .....	<b>6</b>
Installation using Native Access .....	6
Using Kontakt as a plugin in your DAW .....	6
Using Kontakt as standalone application .....	6
<b>6. Overview</b> .....	<b>9</b>
Side pane .....	10
Header .....	14
On-screen keyboard .....	17
Info pane .....	17
<b>7. Browser and presets</b> .....	<b>19</b>
Browser categories .....	21
Using filters .....	22
Using the search field .....	27
Using favorites .....	27
Instrument suggestions .....	28
Info pane .....	28
Managing imported content .....	29
Managing library artwork .....	31
User presets .....	32
<b>8. Instruments and Tools</b> .....	<b>36</b>
Mini Piano instrument .....	36
Leap instrument .....	36
Chords Tool .....	63
Phrases Tool .....	70
<b>9. Classic view</b> .....	<b>80</b>
Building blocks .....	81
Infrastructure .....	82
Instrument Rack .....	82
Instrument Edit Mode .....	88
Loading and Creating Instruments .....	96
Using Snapshots .....	105
Saving and Loading Presets .....	110
Classic View Reference .....	110
<b>10. Using filters and effects in Classic view</b> .....	<b>190</b>
Group insert effects .....	192
Bus insert effects .....	193
Instrument insert effects .....	193
Instrument send effects .....	193
Main effects .....	194



Common parameters .....	195
Adding modules .....	195
Deleting modules .....	195
Editing module parameters .....	196
Signal processors in the Outputs section .....	196
<b>11. Filter reference .....</b>	<b>198</b>
Lowpass filters .....	199
Highpass filters .....	204
Bandpass .....	208
Peak and notch filters .....	210
Multi .....	212
Effect filters .....	214
Equalizers .....	216
<b>12. Effect reference .....</b>	<b>219</b>
Dynamics .....	219
Amplifiers .....	225
Stomps .....	230
Lo-Fi .....	235
Tape .....	236
Modulation .....	238
Mangling .....	247
Delays .....	250
Reverbs .....	254
Spatial .....	259
Utilities .....	264
<b>13. Modulation .....</b>	<b>274</b>
Modulation sources .....	274
Modulation destinations .....	275
Creating modulation assignments .....	275
Deleting modulation assignments .....	276
Assignment controls .....	277
Modulation source reference .....	279
<b>14. MIDI Learn .....</b>	<b>288</b>
Assigning MIDI controllers .....	288
Removing MIDI controller assignments .....	288
<b>15. Options dialog .....</b>	<b>289</b>
Interface .....	289
Engine .....	290
Handling .....	291
Loading .....	293
Libraries .....	294
Memory .....	294
Developer .....	296
Usage data .....	297
Audio .....	297
MIDI .....	298
<b>16. File formats .....</b>	<b>299</b>
Kontakt file formats .....	299
Audio file formats .....	299
<b>17. Keyboard shortcuts .....</b>	<b>301</b>

Global .....	301
Side pane (Classic view) .....	301
Instrument Edit mode .....	301
Group Editor .....	302
Mapping Editor .....	302
Wave Editor .....	302

**18. Version history ..... 303**

Kontakt 7.8 .....	303
Kontakt 7.7 .....	303
Kontakt 7.6 .....	304
Kontakt 7.5 .....	305
Kontakt 7.4 .....	307
Kontakt 7.3 .....	307
Kontakt 7.2 .....	307
Kontakt 7.1 .....	308
Kontakt 7.0 .....	309

# 1. Disclaimer

The information in this document is subject to change without notice and does not represent a commitment on the part of Native Instruments GmbH. The software described by this document is subject to a License Agreement and may not be copied to other media. No part of this publication may be copied, reproduced or otherwise transmitted or recorded, for any purpose, without prior written permission by Native Instruments GmbH, hereinafter referred to as Native Instruments.

“Native Instruments”, “NI” and associated logos are (registered) trademarks of Native Instruments GmbH.

All other trademarks are the property of their respective owners and use of them does not imply any affiliation with or endorsement by them.

Document authored by Adam Hanley, Jan Morgenstern, Nikolas Jeroma, Dinos Vallianatos, Mario Krušelj, Elpiniki Pappa, Hannah Lockwood, Jan Ola Korte, Jonas Körwer

Software version: 8.0 (9/2024)

Special thanks to the Beta Test Team, who were invaluable not just in tracking down bugs, but in making this a better product.



## 2. Welcome to Kontakt

Imagine any sound – Kontakt lets you find it, create it, and transform it. Our instrument platform combines a brand-new set of intelligent tools with countless sound design options, redefining how you generate ideas and make music.

Kontakt hosts the world's largest range of virtual instruments. With thousands of libraries, it's the gateway to quality sound from Native Instruments, our official partners, and scores of indie developers. Plus, everything is completely tweakable, so you can make any sound your own.

Tools add a completely new layer of creative features to get the ideas flowing. And they work with any Kontakt instrument, old and new. Our first Tools, Chords and Phrases, are designed to spark new ideas and get you in the zone fast.

Leap is an ultra-fast and playful way to play and manipulate loops. Spark fresh ideas, sprinkle in expressive performance effects, or just jam. Breathe new life into your sample collection or try something totally fresh with our new Leap Expansions series.

If you want to dive deeper, you can use Kontakt to create sophisticated sample-based virtual instruments, process their audio signals with powerful DSP structures, build complex performance setups with extensive modulation routing, and gain access to a vast range of creative third-party sample libraries.

Get started by learning more [about Kontakt](#), how to [install and setup](#) the software, and all of its features, starting with the [overview](#).

We hope you enjoy Kontakt!

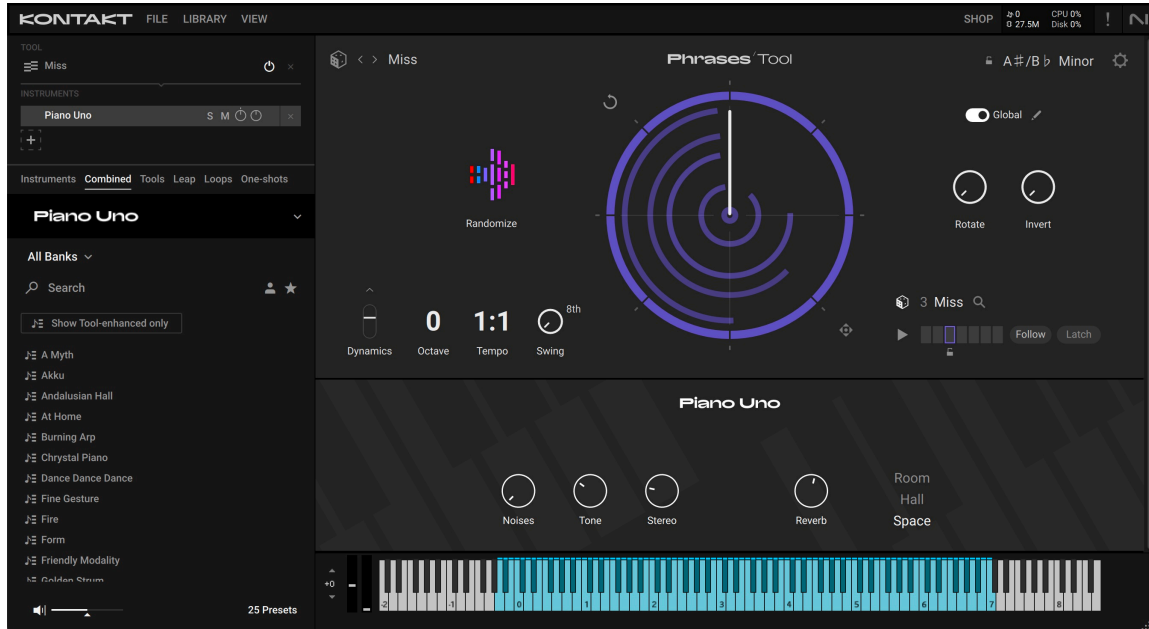

## Document conventions

In this document the following formatting is used to highlight useful information:

<i>Italics</i>	Indicates paths to locations on your hard disk or other storage devices.
<b>Bold</b>	Highlights important names, concepts, and software interface elements.
[Brackets]	References keys on the computer keyboard.
▶	Denotes a single step instruction.
→	Denotes the expected result when following instructions.

The following three icons denote special types of information:



The **light bulb** icon indicates a useful tip, suggestion, or interesting fact.



The **information** icon highlights essential information in a given context.



The **warning** icon alerts you of potential risks and serious issues.

## Further resources

In addition to this user guide, further documentation about Kontakt and its related tools can be downloaded from [the NI website](#). The following documents are available:

- The [Kontakt Factory Library Manual](#) provides an overview of the different features and controls available in each of the Factory Library Instrument collections.
- The [KSP Reference Manual](#) documents the built-in scripting language, which allows instrument creators to embed scripts that can dynamically alter MIDI data and playback parameters in their patches. As such, it is targeted towards advanced users.
- The [Komplete Script documentation](#) provides information on the Komplete UI framework for high-DPI reactive interfaces.
- The [Kontakt Lua API Manual](#) documents the technology enabling programmatic instrument editing.
- The [Creator Tools Reference Manual](#) documents the suite of tools developed to support the instrument creation process within Kontakt. Here you will find scripting and binding references for the Debugger and the Instrument Editor.
- The [Kontakt Factory Library Scripts Manual](#) provides an overview of the different features and parameters available in the Script Editor of the Factory Library Instruments.



When using the Kontakt standalone application you can use the **Help** menu in the application menu bar to access online documentation and our knowledge base.

## 3. About Kontakt

Kontakt is the industry-standard instrument platform for music creators, combining access to thousands of sound libraries with powerful tools for creating your own instruments.

Kontakt comes with 900+ instruments that you can add to your library by downloading the Kontakt Factory Library 2 in Native Access. On the [Native Instruments website](#) you can get hundreds of officially licensed instruments from Native Instruments and other manufacturers.

In addition to hosting instruments, Kontakt enriches them with Tools, a suite of MIDI effects for generating [Chords](#) and [Phrases](#) in real time. Kontakt also features [Leap](#), a sample playground that lets you play and manipulate loops and one-shots to create exciting ideas and performances.

Kontakt integrates seamlessly with popular DAWs and hardware controllers, and the advanced integration with S-Series MK3 keyboards enhances your creative workflow with hands-on control over your Kontakt instruments.

You can choose between different views in Kontakt depending on your goals. The [Default view](#) lets you to quickly play and combine Kontakt Instruments, Tools, and Leap. If you want to build your own instruments, the [Classic view](#) gives you all the features to create instruments from scratch.



As an instrument builder, you will benefit from the Komplete Instrument Building Toolkit, featuring the Komplete Script language and Komplete UI framework. Find relevant documentation linked in [Further resources](#).



## 4. New in Kontakt 8

The following features have been added or improved in Kontakt 8:

- **Tools:** Kontakt 8 introduces Tools, a new framework for creatively manipulating MIDI that works seamlessly with all Kontakt instruments. **Chords** comprises a vast collection of chord sets, letting you play entire chord progressions with the press of a single key. Similarly **Phrases** lets you play melodies by pressing a single key. For more information refer to [Instruments and Tools](#).
- **Leap:** The new Leap framework lets you play and perform loops and one-shot samples. It comes with new perform effects and a streamlined interface to quickly customize samples. For more information refer to [Leap instrument](#).
- **Default view:** Kontakt 8 comes with a new Default view. The new side pane lets you connect Tools to instruments, mix various instruments in your Rack, and quickly load and swap presets for both Tools and instruments. Classic view is still available using the View menu in the Header. For more information refer to [Side pane](#).
- **Mini Piano:** Kontakt 8 now ships with an easy-to-use piano instrument. Great for kickstarting creative ideas, or to just play while installing the Factory Library. For more information refer to [Mini Piano instrument](#).
- **Improved Wavetable module:** The Wavetable module has received a second Form shaper as well as a modulation oscillator, complete with several wave shapes. It allows for phase and frequency modulation and significantly expands Kontakt's synthesis capabilities. For more information refer to [Wavetable](#).
- **Complete UI:** With the release of Kontakt 8 we are introducing a new framework to build high-DPI interfaces, called Complete UI. It features a new language, called Complete Script, and enables instrument builders to efficiently create instruments that not only sound but also look beautiful. For more information refer to [Complete UI docs](#).

## 5. Installation and setup

Learn how to download and install Kontakt using Native Access and get started making music.

### Installation using Native Access

Native Access is your go-to app for downloading, activating, and updating all your NI music creation tools including Kontakt and its libraries. If you are new to Native Instruments, you will first have to create your Native ID user account. To learn more about Native Access, visit our [support page](#).

1. Download and install Native Access [here](#).
2. Open the Native Access application.
3. Create a Native ID, if you do not have one already.
4. Login to Native Access using your Native ID.
5. Click **Library** on the left side of Native Access.
6. Click **Available** at the top of Native Access.
7. Click the **Kontakt** category to only show products related to Kontakt.
8. Click **Install** for the following products:
  - Kontakt 8
  - Kontakt Factory Library 2

→ The software is installed automatically.

### Using Kontakt as a plugin in your DAW

The plugin version of Kontakt lets you use it as an instrument inside your DAW. You can run multiple instances of Kontakt alongside other instrument and effect plugins. When used as a plugin, Kontakt relies on your DAW to receive MIDI. Kontakt's audio output is directly sent to your DAW's mixer.

Kontakt is available in VST3, Audio Units (AU), and AAX plug-in formats. Once installed, Kontakt will appear in the plugin lists of any compatible DAW you have installed on your system. If Kontakt does not show up, refer to [this](#) article in our Knowledge Base for help.

If you want to learn more about how to load and play instrument plugins like Kontakt in your DAW, please refer to the documentation provided by the manufacturer.

### Using Kontakt as standalone application

When you open Kontakt from your system's application folder, it will launch as standalone application independently of a DAW or another plugin host. The Kontakt standalone application receives MIDI from one or more ports of a MIDI interface and sends audio signals directly to your audio interface.

This enables you to use Kontakt as a live performance instrument or as a sampling host on a dedicated computer. If you are creating your own instruments using Kontakt, the standalone application can offer a more focused workflow.

When you open the Kontakt standalone application for the first time, you will need to configure the audio and MIDI settings in the Options dialog to connect Kontakt to your audio interface and MIDI controller.

- To open the **Options dialog**, click the **File** menu in the Kontakt Header and select **Options**. Alternatively, you can press F12 on your computer keyboard.

## Audio configuration

In the **Audio** tab of the **Options** dialog, you can specify which audio device Kontakt should use for playback and adjust global playback parameters.

The Audio tab provides the following options:

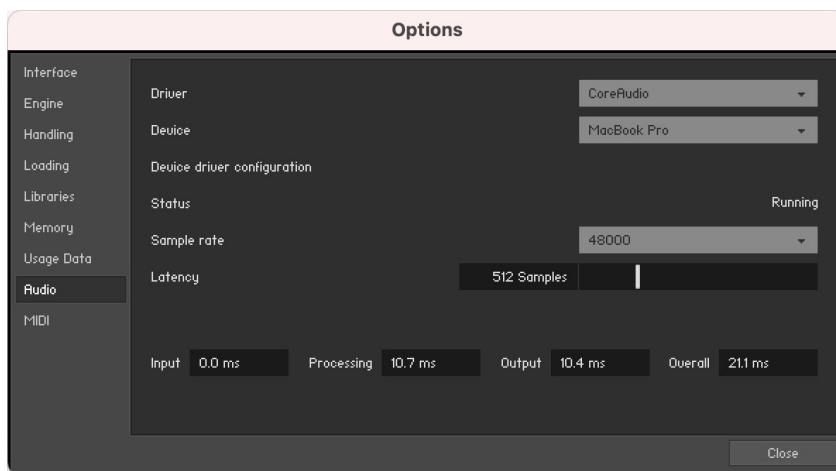

- **Driver:** With this drop-down menu, you can select which of your operating system's device driver architectures Kontakt should use. Most professional audio devices provide ASIO, CoreAudio (Mac) or WASAPI (Windows) drivers.
- **Device:** This menu lists all connected audio interfaces that match the driver architecture chosen above. Use this to select the audio interface that you would like to use for playback.
- **Sample rate:** This drop-down menu allows you to set the global playback sample rate at which Kontakt will operate. Common values are 44100 Hz for music and 48000 Hz for film production. Note that this does not have anything to do with the sampling rate at which your samples have been recorded — if the playback rate does not match a sample's recording rate, Kontakt will handle all necessary conversion steps transparently for you.
- **Latency:** The size of the audio playback buffer in samples. Small values will shorten the delay between pressing a key and hearing the resulting sound (this is called "latency"), but may cause drop-outs and stuttering when playing a lot of voices at the same time. Conversely, setting this to a higher value will make playback more reliable at the cost of more latency. Note that this control is not always available, as sometimes the latency is handled by your hardware drivers.



Learn more about latency and how to optimize your audio settings and system configuration for best performance, refer to [this article](#) in our Knowledge Base.



## MIDI configuration

The **MIDI** tab of the **Options** dialog provides a list of all MIDI inputs and outputs that have been found on your system. These are ports of physical MIDI interfaces connected to your computer, but also any virtual MIDI ports that may be provided by drivers or other applications to facilitate inter-application MIDI usage.

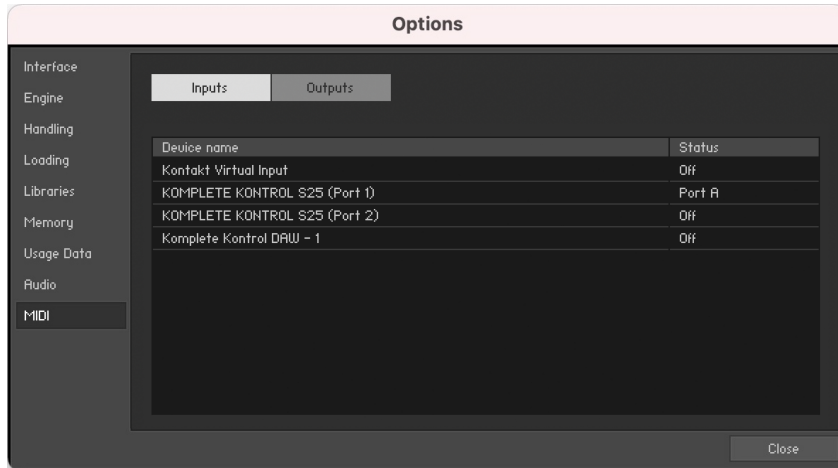

In order to make Kontakt respond to MIDI data from the outside, you have to enable one or more ports that appear in the inputs list of the **MIDI** tab. Make sure the **Inputs** button is highlighted and identify the port(s) that you intend to use for MIDI input in the list. If the **Status** field on the right side of an entry reads **Off**, click that value and assign one of the MIDI port identifiers (A-D). This enables the respective port, which will later be identified by the selected letter throughout the user interface.

## 6. Overview

When you open Kontakt, the Library browser will invite you to load your first preset and start playing. Once you have loaded a preset, the main window lets you tweak instruments, continue browsing, and configure Kontakt.

**i** Learn how to use the Library browser in [Browser and presets](#).

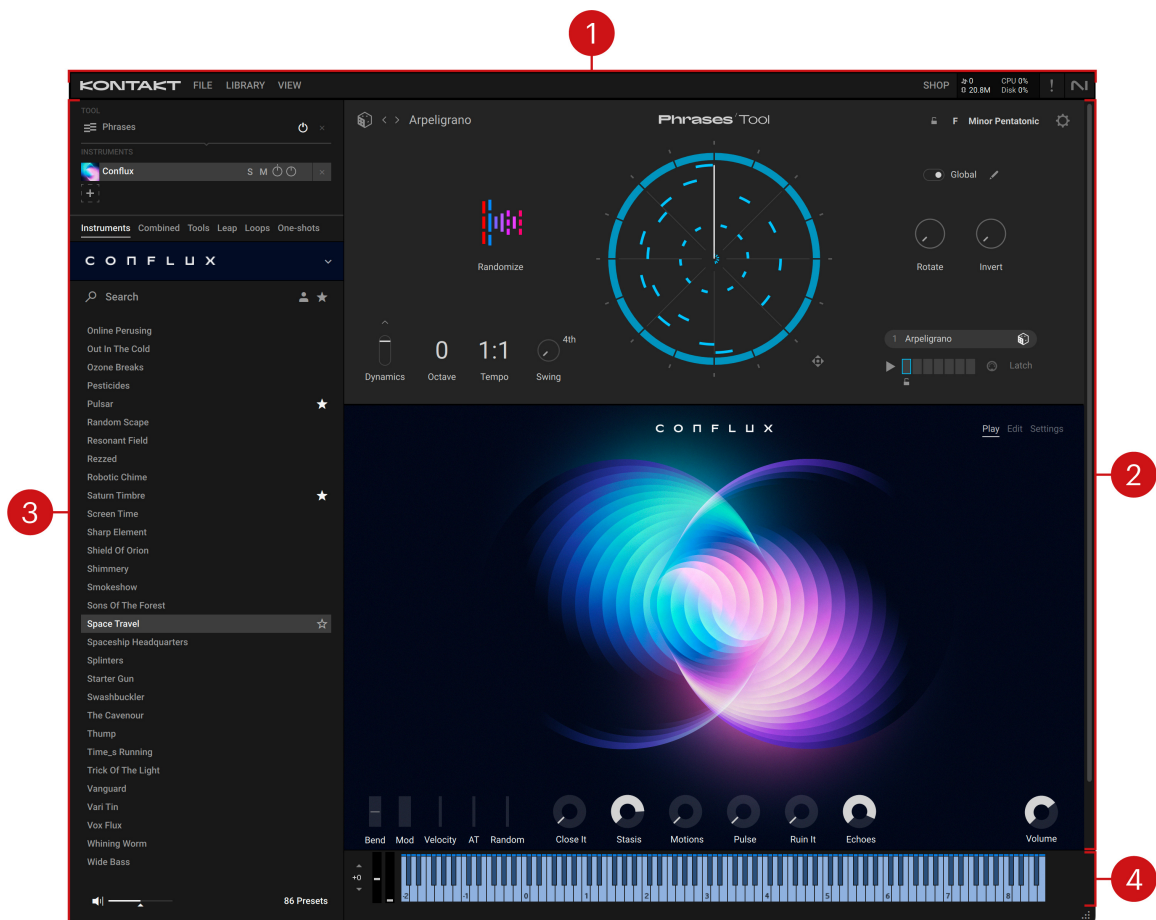

- 1. Header:** Lets you open the Library browser, show or hide elements in the user interface, and access options in the File menu. Additionally, the displays and meters keep you informed about the software status. For more information, refer to [Header](#).
- 2. Rack:** Shows the instruments and tools you have loaded, each letting you tweak and edit your sounds in its own dedicated user interface. To learn more about the included Mini Piano, Leap, and Tools, refer to [Instruments and Tools](#). Information about the instruments included in the Kontakt Factory Library 2 is available in the [Kontakt Factory Library 2 online manual](#).
- 3. Side pane:** Lets you combine tools and instruments, control mixer functions including the volume levels, and show all presets of a loaded instrument in the side pane browser. For more information, refer to [Side pane](#).
- 4. On-screen keyboard:** Enables you to play instruments with your mouse, and shows the instrument's key mapping. You can hide or show the on-screen keyboard using the **View** menu in the Header. For more information, refer to [On-screen keyboard](#).



You can use the View menu in the Header to display the [Info pane](#), which shows brief descriptions of user interface elements when you hover the mouse cursor over them.

## Side pane

At the top of the side pane, the Navigator lets you view and manage the contents of the Rack. Below the Navigator, the side pane browser makes it easy to add or replace a Tool or an instrument in the Rack, and explore presets without switching views in Kontakt.

The side pane consists of the following areas:

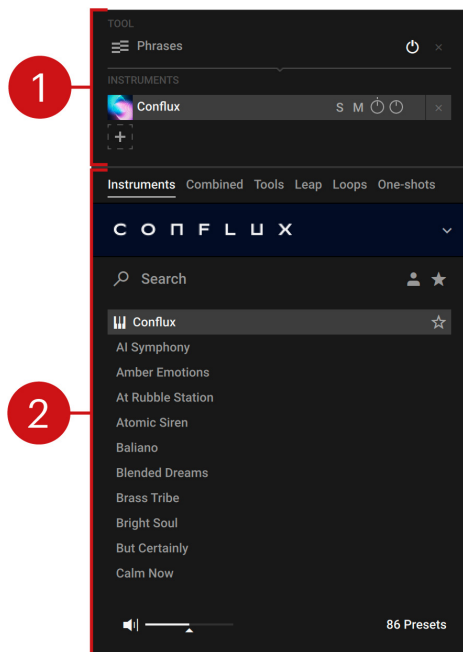

- 1. Navigator:** Shows the Tools and instruments in your Rack, and lets you manage them. For more information, refer to [Navigator](#).
- 2. Side pane browser:** Lets you add a Tool or an instrument to your Rack and browse its presets. For more information, refer to [Side pane browser](#).

## Navigator

The Navigator lets you view, manage, and mix the instruments in the Rack, and connect them to Tools, for example [Chords](#) and [Phrases](#). You can also use it in conjunction with the [side pane browser](#) to add or replace a Tool or an instrument in the Rack.

The Navigator contains the following elements and controls:



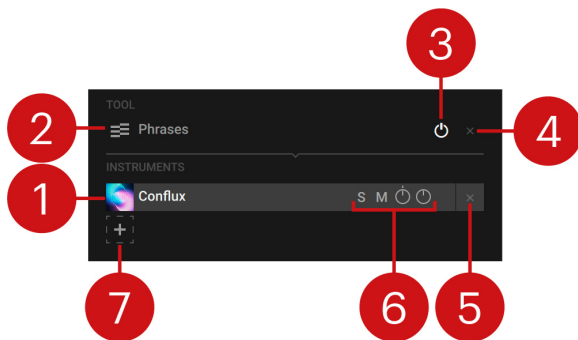

1. **Instrument slot:** Represents a single instrument in the Rack, and its position. Clicking on the entry lets you browse the instrument's preset in the side pane browser, or replace it by loading another instrument. Right-clicking opens the context menu that you can use to clear the slot, save a user preset, and set the MIDI input.
2. **Tool slot:** Represents the Tool loaded in the Rack. Clicking on the entry lets you browse the Tool's presets using the side pane browser, or replace it by loading another Tool. Right-clicking opens the context menu that you can use to clear the slot, save a user preset, and set the MIDI input.

**i** If the slot does not contain a Tool, a **+** icon is shown. Clicking the **+** icon lets you add a Tool to the Rack.

3. **Tool on/off:** Switches the Tool on or off. When switched off, its functionality is bypassed.
4. **Clear Tool slot:** Removes the Tool from the Rack.
5. **Clear instrument slot:** Removes the respective instrument from the Rack.
6. **Instrument controls:** Let you adjust mixer controls for each instrument.
  - **Solo (S):** Solos the respective instrument, muting the audio from all other instruments.
  - **Mute (M):** Mutes the respective instrument's audio.
  - **Pan:** Adjusts the position of the respective instrument in the stereo field.
  - **Volume:** Adjusts the volume level of the respective instrument.
7. **Add instrument:** Adds another instrument to the Rack.

## Navigator context menu

The context menu in the navigator lets you clear a Tool or instrument slot, save a user preset, and set the MIDI input.

- To open the context menu, right-click a Tool or an instrument slot.



The Navigator context menu contains the following entries:

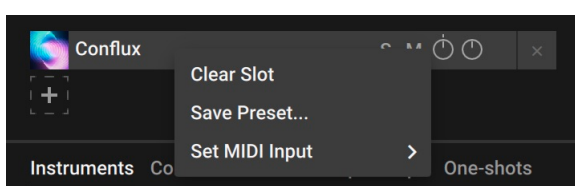

- **Clear Slot:** Removes the Tool or instrument from the Rack.
- **Save Preset...:** Saves a user preset for the Tool or instrument loaded in the slot. For more information, refer to [Saving a User preset](#).
- **Set MIDI Input:** Selects the MIDI input used for the instrument loaded in the slot. This entry is not available in the Tool slot.

## Side pane browser

The side pane browser makes it easy to explore all of the presets for individual products loaded in the Rack without switching views in Kontakt. You can also use it in conjunction with the [Navigator](#) to add or replace a Tool or an instrument in the Rack.

The side pane browser contains the following elements and controls:

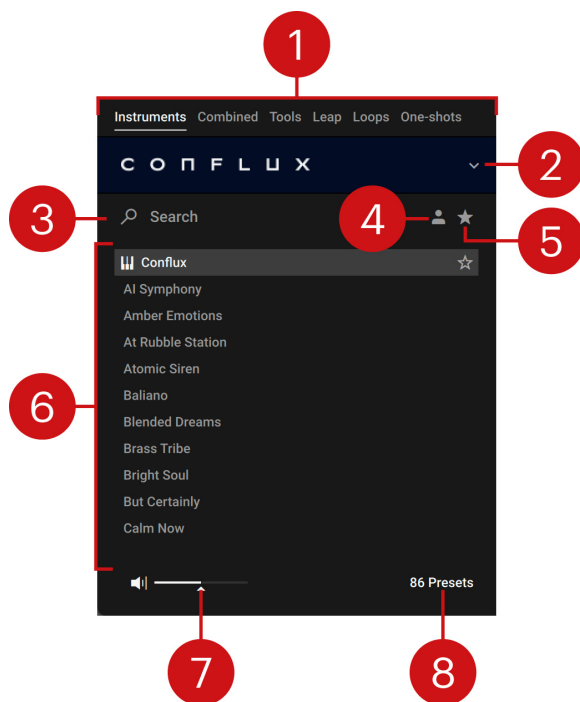

1. **Category selector:** Selects the category of content displayed in the Browser, from instruments to Tools and Leap instruments. For more information, refer to [Browser categories](#).
2. **Product selector:** Opens the Product selector that you can use to add or replace a Tool or an instrument in the Rack. For more information, refer to [Product selector](#).
3. **Search field:** Filters presets according to text entered in the field. The search engine considers the preset name, author, Brand / Character / Sound Type tags, product and bank name. The Results list is filtered according to the terms entered in the Search field. Refer to [Using the search field](#).
4. **User Content:** Filters by user content. When activated, the Browser only shows user presets. When deactivated, the Browser only shows factory presets. For more information on user presets, refer to [User presets](#).
5. **Favorites** (star icon): Displays only your Favorites in the Results list. You can define any presets in the Results list as Favorites, creating quick access to a custom collection of your most beloved presets. Refer to [Using favorites](#).

6. **Results list:** Displays the list of presets corresponding to your search criteria. Presets are listed in alphabetical order and the selected preset is highlighted. Click a preset to audition the sound without loading the preset. Double-click a preset to load it into the current slot. You can also use the up/down arrows on your computer keyboard to select the previous/next preset from the list. You can expand or shrink the list area by clicking and dragging the left border of the Results List.
7. **Audition controls:** Adjusts the volume at which presets are auditioned as you select them in the Results list. Auditioning presets is active by default and can be muted by clicking the speaker icon.
8. **Preset count:** Shows the number of presets in the Results list.

## Product selector

The Product selector lets you add a Tool or an instrument to your Rack, or replace existing ones.

- ▶ To open the Product selector and add a product to the Rack, click the **+** icon for either **TOOL** or **INSTRUMENTS** in the [Navigator](#).

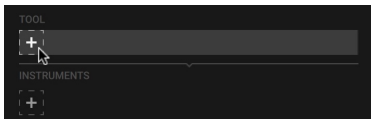

- ▶ To open the Product selector and replace the currently selected product, click the product logo bar in the [side pane browser](#).

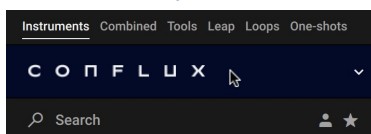

- i** A product will be added or replaced once you load one of its presets from the Results list.

The Product selector consists of the following elements:

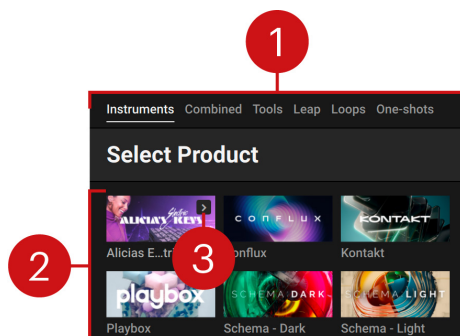

1. **Category selector:** Selects the category of content displayed in the Browser, from instruments to Tools and Leap instruments. For more information, refer to [Browser categories](#).
2. **Product tiles:** Selecting a tile shows the product's presets in the Results list.
3. **First preset:** Loads the first preset of the respective product. This button is only shown when hovering the mouse cursor over the product tile.

## Header

The Header at the top of the Kontakt window lets you access the File menu, the Library browser, and the View menu for configuring the user interface. Additionally, it shows performance information including CPU and hard drive load.

The Header consists of the following menus and elements:



1. **File:** Opens the File menu that contains options related to saving, loading, and creating new presets and instruments. Additionally, it lets you access the Options dialog with software preferences. For more information, refer to [File Menu](#) and [Options dialog](#).
2. **Library:** Opens the Library browser, which lets you explore all of your libraries and user content. For more information, refer to [Browser and presets](#).
3. **View:** Opens the View menu that contains options related to configuring Kontakt's user interface. For more information, refer to [View Menu](#).
4. **Shop:** Links to the Native Instruments web shop where you can find new instruments to add to your library.
5. **System performance information:** Reports key metrics about Kontakt's performance as well as CPU and hard drive load. Additionally, you can use the Engine restart button to initialize the audio engine. Refer to [System performance information](#).

## File menu

The File menu lets you create new Leap presets, load custom instruments from your hard drive, manage your files, and access the Options dialog.

The File menu contains the following options:



- **New Leap preset:** Opens Leap with an empty kit that you can use to combine and play any of the loop and one-shot samples in your library. For more information, refer to [Loading and saving Leap kits](#).

- **Load...:** Opens a file dialog that lets you load compatible files from your hard drive, for example an instrument (.nki), a multi (.nkm), or an instrument bank (.nkb). If samples are missing for the loaded instrument, you can use the [Samples Missing dialog](#) to find them.
- **Load recent:** Shows a list of recently used files and lets you open them.
- **Save as:** Opens a list of all instruments in the Rack. Selecting an entry opens a file dialog that lets you save the respective instrument. In the file dialog, you can define how Kontakt will save sample files that are used by the instrument. For more information, refer to [Saving instruments](#)
- **Save multi as...:** Saves the contents of your Rack as a Multi file (.nkm). The Multi contains all instrument settings as well as the output routing options. You can define how Kontakt will save sample files for all contained instruments using the file dialog as described in [Saving instruments](#).
- **Save as default multi:** Saves the contents of your Rack as default template that Kontakt will load at startup or when you select **Reset multi**.
- **Reset multi:** Restores the default template that is loaded at startup, removing all instruments from your Rack.
- **Options...:** Opens the Options dialog with global preferences, including the audio and MIDI settings. For more information, refer to [Options dialog](#).
- **Batch resave:** Enables you to find missing samples for multiple custom instruments at once. For more information, refer to [Batch resave](#).
- **Collect samples / Batch compress:** Enables you to collect all samples for a number of instruments and compress the files to save hard drive space. For more information, refer to [Collect samples / Batch compress](#).
- **Global purge:** Enables you to free the memory of any unused samples. For more information, refer to [Global purge](#).
- **Controller:** Shows the connected Kontrol keyboard. When a Kontrol keyboard is connected, the corresponding entry is indicated by a checkmark.

**i** When using Classic view, the File menu has additional entries that let you create and save custom instruments. For more information, refer to [Creating Instruments](#) and [Saving instruments](#).

## View Menu

The View menu lets you choose which elements of the Kontakt interface are shown. Depending on whether you are using Default view or Classic view, different options are given.

### View menu options in Default view

In Default view the View menu contains the following options:

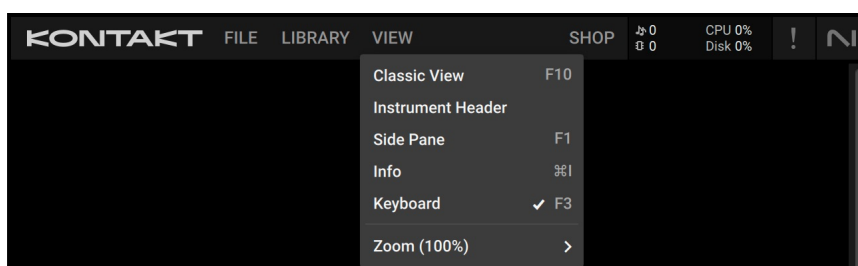

- **Classic View:** Switches Kontakt to Classic view.
- **Instrument Header:** Displays the header for each instrument in the Rack, letting you configure instrument options.
- **Side pane:** Displays the side pane on the left side of the Kontakt window. For more information, refer to [Side pane](#).
- **Info:** Displays the Info pane, which shows brief descriptions of user interface elements when you hover the mouse cursor over them. For more information, refer to [Info pane](#).
- **Keyboard:** Displays the virtual on-screen keyboard, which enables you to play instruments with your mouse, and shows the instrument's key mapping. For more information, refer to [On-screen keyboard](#).
- **Zoom:** Sets the zoom scaling of the Kontakt window and allows switching between three performance modes for the user interface: Best quality, Balanced, and Best performance.

## View menu options in Classic view

In Classic view the View menu contains the following options:

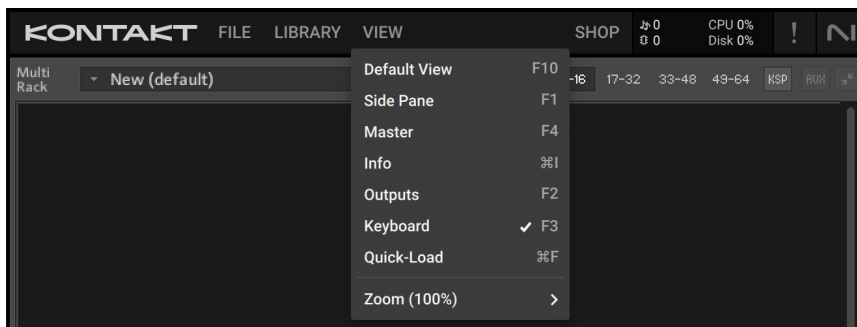

- **Default View:** Switches Kontakt to Default view.
- **Side pane:** Displays the side pane on the left side of the Kontakt window. For more information, refer to [Side Pane \(Classic view\)](#).
- **Master:** Displays the Master Editor panel, which contains a number of global parameters and common utility functions. For more information, refer to [Master Editor](#).
- **Info:** Displays the Info pane, which shows brief descriptions of user interface elements when you hover the mouse cursor over them. For more information, refer to [Info pane](#).
- **Outputs:** Displays the Outputs section at the bottom of the Rack. For more information, refer to [Outputs Section](#).
- **Keyboard:** Displays the virtual on-screen keyboard, which enables you to play instruments with your mouse, and shows the instrument's key mapping. For more information, refer to [On-screen keyboard](#).
- **Quick-Load:** Displays the Quick-Load Catalog, which is a user-defined browser for quick access to your favorite Kontakt files. For more information, refer to [Quick-Load Catalog](#).
- **Zoom:** Sets the zoom scaling of the Kontakt window and allows switching between three performance modes for the user interface: Best quality, Balanced, and Best performance.

## System performance information

The system performance information on the right side of the Header reports key metrics about Kontakt's performance as well as CPU and hard drive load. The values are updated in real time and give you an idea of how Kontakt affects your system's resources.

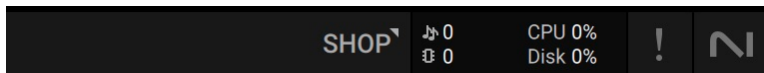

- **Voice count (notes icon):** The total number of voices that are currently being played by all instruments loaded in this instance of Kontakt.
- **Sample memory (memory chip icon):** The total amount of allocated sample memory.
- **CPU:** The CPU load in percent, giving you visual feedback about the available processing resources when adding more instruments.
- **Disk:** The disk load in percent, giving you visual feedback about the available hard drive bandwidth when adding more instruments.
- **Engine restart (! icon):** Initializes the audio engine and all loaded instruments, which is useful when Kontakt instruments get stuck on notes or overload the CPU persistently. Any settings you made in the instruments are preserved.

## On-screen keyboard

Kontakt provides a virtual on-screen keyboard that can be used to play instruments with your mouse when a MIDI keyboard is not available.

- To show the on-screen keyboard, click the **View** menu in the Header and select **Keyboard**. Alternatively, you can press F3 on your computer keyboard.

The on-screen keyboard contains the following features and controls:



- **Keys:** When a key is clicked, the keyboard generates a corresponding note event that will be received by the currently selected Instrument. The note's velocity is relative to where on the key you click: clicking towards the top of the key will produce notes with a low velocity, and clicking towards the bottom of the key will produce notes with a high velocity.
- **Pitch and mod wheel:** Click and drag the Pitch and Modwheel to generate pitch bend and MIDI CC #1 data respectively.
- **Transposition:** Shift the displayed key range up and down in octaves.
- **Key range:** The keyboard uses colors to indicate the key ranges of the current Instrument.
  - **Playable keys:** Keys that produce sound are colored blue.
  - **Keyswitches:** Keys that trigger articulations and other changes in the instrument's behavior are colored red. Keyswitches do not trigger sound by themselves and are played in combination with regular keys.
  - **Special functions:** Some libraries use colors differently to indicate specific use cases, for example keyboard splits or different instrument types.

## Info pane

The Info pane displays a help text when you hover the mouse cursor over a user interface element, like buttons or other controls.

- To show the Info pane at the bottom of the Rack, click the **View** menu in the Header and select **Info Pane**. Alternatively, you can press command + I (macOS) or Ctrl + I (Windows) on your computer keyboard.

Content related to Kontakt's Classic view is translated in English, German, French, Spanish and Japanese. Language preferences are set using the **Language** drop-down menu in the **Interface** tab of the **Options** dialog. When selecting **Automatic**, Kontakt will follow the language selection of your operating system. Language settings only take effect after restarting Kontakt.



## 7. Browser and presets

The Browser provides access to all your Kontakt factory content (Instruments, Loops, One-shots and Effects), as well as your own user content. Sophisticated browser functionality allows you to filter sounds by tags, brand, product, bank, text search, user presets and Favorites, helping you to quickly and intuitively find the right presets for your musical needs.

Player-licensed content will appear automatically in the Browser and you can import non-player content into the Browser.

► To open the Browser, click the Browser icon in the Main Control Panel.

The Browser contains the following features and controls:

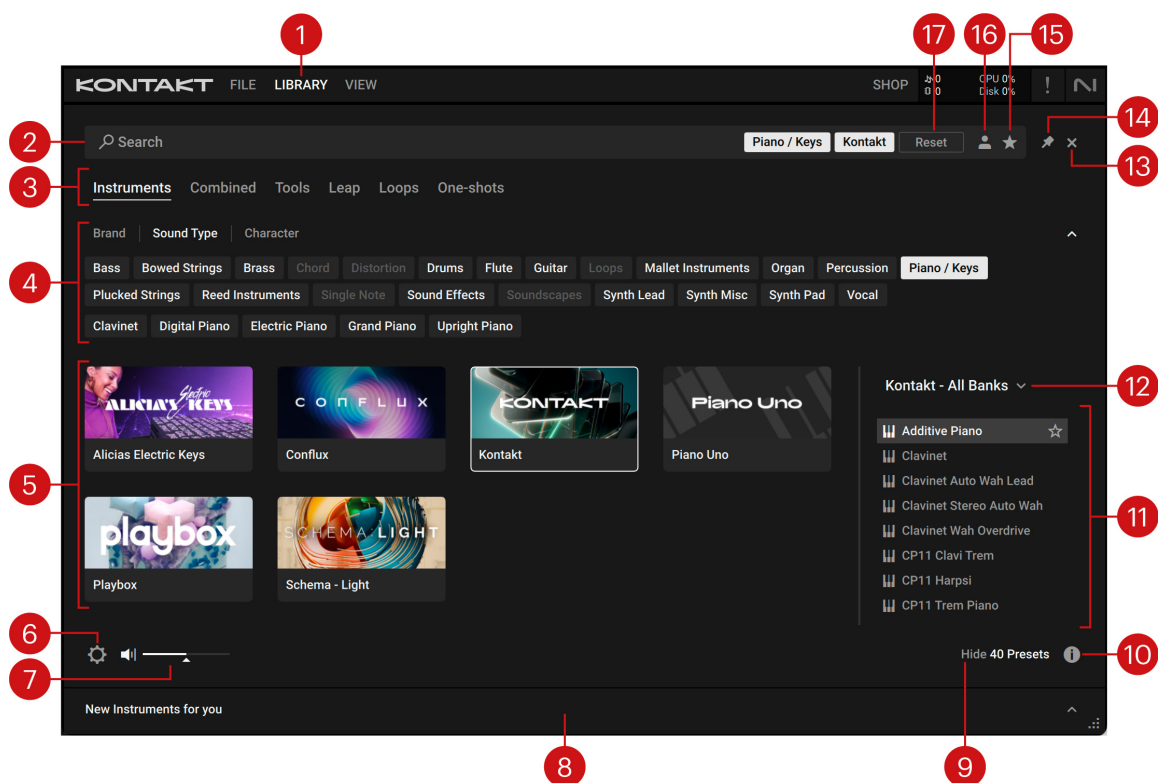

1. **Library:** Opens and closes the Browser.
2. **Search field:** Filters presets according to text entered in the field. The search engine considers the preset name, author, Brand / Character / Sound Type tags, product and bank name. The Results list is filtered according to the terms entered in the Search field. Refer to [Using the search field](#).
3. **Category selector:** Selects the category of content displayed in the Browser, from instruments to Tools and Leap instruments. For more information, refer to [Browser categories](#).
4. **Tag filters:** Contains Brand, Sound Type, and Character filters, which use NKS tagging to enhance the browsing experience. Switch between the three filters interchangeably and explore tags that classify and organize presets based on the manufacturer as well as various musical attributes and functions. You can hide these filters by clicking the arrow icon on the right to minimize the filter section. Refer to [Using filters](#).

5. **Product filter:** Displays your Kontakt Libraries as tiles. Selecting a tile filters the Results list with relevant presets. Hovering over a tile reveals an arrow icon (➤) which when clicked loads the first preset of the associated product. Browsing with tag filters and text search adjusts the Product filter accordingly. Refer to [Filtering by product](#).
6. **Import Content** (cogwheel icon): Opens a dialog that allows you to import, remove and rescan your custom content and non-player libraries. Refer to [Managing imported content](#).
7. **Audition controls:** Adjusts the volume at which presets are auditioned as you select them in the Results list. Auditioning presets is active by default and can be muted by clicking the speaker icon.
8. **Instrument suggestions:** Displays instruments currently not owned but available in the Native Instruments online shop. These suggestions change based on the text input of the search field and the selected Sound Type tag. Clicking on an instrument opens the respective shop website in the internet browser.
9. **Show/Hide Presets:** Displays and hides the Results list. Click **Show Presets** to display the Results list, or click **Hide Presets** to hide it. The number of presets currently displayed in the Results list is also indicated. This useful feature allows you to monitor the effect of your filtering, highlighting the potential need for tag refinement to help narrow down extensive Results lists.
10. **Info (I):** Shows/hides the Info pane, which displays information relating to the properties and tags of the selected preset. You can also assign tags to user presets in this pane. The Info pane is only available when the Results list is displayed. Refer to [Info pane](#).
11. **Results list:** Displays the list of presets corresponding to your search criteria. Presets are listed in alphabetical order and the selected preset is highlighted. Click a preset to audition the sound without loading the preset. Double-click a preset to load it into the current slot. You can also use the up/down arrows on your computer keyboard to select the previous/next preset from the list. You can expand or shrink the list area by clicking and dragging the left border of the Results List.

- The Results List will display this icon next to a list entry if it is an instrument.



- The Results List will display this icon next to a list entry if it is a preset that combines multiple instruments, or instruments and tools.



**i** Loading a sample from the Loops or One-shots category will open a new Leap kit. When using [Classic view](#), a new custom instrument will open instead.

12. **Bank filter:** Contains all banks and sub-banks (if any) of the selected product. Selecting a bank or a sub-bank filters the Results list accordingly.
13. **Close (x icon):** Closes the Browser when clicked.
14. **Pin** (pin icon): Pins the Browser open while you search for presets. By default, Pin is deactivated and the Browser closes automatically when you load a preset. Clicking the Pin button activates Browser pinning, allowing you to audition and load presets without closing the Browser automatically.
15. **Favorites** (star icon): Displays only your Favorites in the Results list. You can define any presets in the Results list as Favorites, creating quick access to a custom collection of your most beloved presets. Refer to [Using favorites](#).

16. **User Content:** Filters by user content. When activated, the Browser only shows user presets. When deactivated, the Browser only shows factory presets. For more information on user presets, refer to [User presets](#).
17. **Reset:** Resets all filters, including the brand, product, bank and sub-bank, as well as the Sound Type and Character tags. In addition, the User Content and Favorites switches are turned off. You end up with the full list of factory presets available.

 **Factory** refers to content created by a manufacturer. **User** refers to content that you or other users have created.

## Browser categories

The Library browser in Kontakt features categories that let you quickly access different types of content, from your instruments to Tools and Leap, as well as all the Loops and One Shots from the Expansions you have installed.

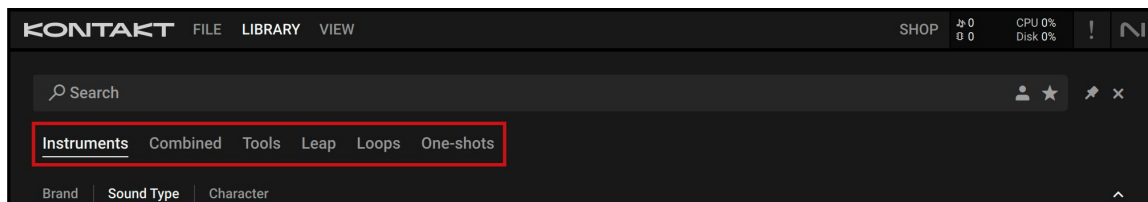

## Instruments

Instruments is where you can browse all the Kontakt instruments you have installed on your computer. Our vast collection on the Native Instruments website includes pianos, drums and percussion, orchestral instruments, synthesizers, and more. Once installed through Native Access they will show up here under Instruments.

 The included Mini Piano will get you started even if you don't have any other instruments installed. Learn more in [Mini Piano instrument](#).

## Combined

Combined gives you access to presets containing multiple instruments, and the brand new Tool-enhanced presets. These combine instruments with Tools that transform your playing in inspiring ways. Included in Kontakt 8 are the Chords Tool and the Phrases Tool. Learn more in [Instruments and Tools](#).

 The option to **Show Tool-enhanced only** lets you browse presets that feature our new Tools, Chords and Phrases.

## Tools

Tools is where you will find our new Tools, Chords and Phrases. The Chords Tool comes with more than 100 chord sets, and the Phrases Tool offers more than 100 phrase sets, covering a wide range of different genres and styles. Both Tools give you exciting features to manipulate the chords and phrases and real time. Learn more in [Instruments and Tools](#).

## Leap

Leap is where you can browse Expansions with kits ready to be loaded in our new Leap sampler. Use its engines to make each sound your own, and create exciting performances with Macro knobs and black keys effect. Get inspired by our Expansions, each dedicated to a certain genre, mood, or style, or use Leap to create your own kits. You can buy more Expansions on the Native Instruments website. Once installed through Native Access they will show up here under Leap. Learn more in [Leap instrument](#).

## Loops

Loops contains all your audio loops, such as riffs, motifs, drums loops, and more. These loops are part of the Expansions you have installed on your computer. You can buy more Expansions on the Native Instruments website. Once installed through Native Access the included audio loops will show up here under Loops, ready to be combined and played using Leap. Learn more in [Loading samples and kits](#).

## One-shots

One-shots contains all your single sound samples, such as drum hits, keys, synths, guitars, basses, and more. These samples are part of the Expansions you have installed on your computer. You can buy more Expansions on the Native Instruments website. Once installed through Native Access the included samples will show up here under One-shots, ready to be combined and played using Leap. Learn more in [Loading samples and kits](#).

## Using filters

Filters enable you to search for sounds using NKS tags and Library tiles. Tags are used to characterize and classify presets based on various musical attributes. All Kontakt Library presets have been tagged in a meaningful way to encourage your sonic exploration and help you find results quickly.

Three main Filters can be used to help enhance your browsing – Library tiles, Sound Type tags and Character tags. Library tiles allow you to search and filter for preset sounds within a specific Library. Selecting a Library tile will display preset results only available to that product, whilst highlighting all relevant tags. Sound Type and Character filters use NKS tags to search for preset sounds. Switch between the two Filters interchangeably by clicking the respective name. Type and Character tags in addition to the Search field can be used to further refine your search results. Hide the Sound Type and Character filters by clicking the arrow icon to minimize the section. A **Reset** button will appear in the search bar when a filter is applied. Click this to reset all filters.

## Filtering by sound type

Sound Type tags are structured into two hierarchical levels, allowing you to search for files based on applied Type and Subtype tags. The Sound Type filter initially displays top-level tags only, whilst selecting a tag will display the related NKS Subtype tags below. The hierarchical structure means that Subtype tags are specific to the respective Sound Type tag. This provides quick access to a range of presets from different Libraries that share similar sonic functions.

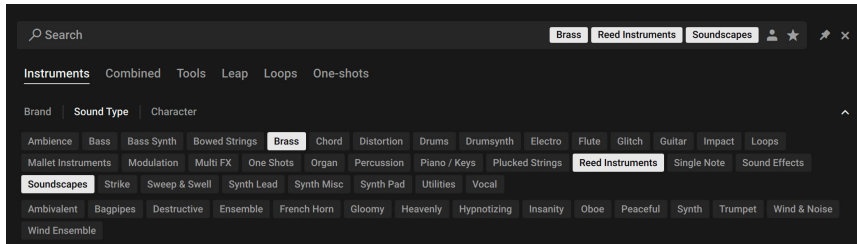

Selecting multiple tags helps you to further refine your search. In the case of multi-selection, repeating Subtype tags are merged into a single tag. When selecting multiple tags, the last item added to the selection is also focused.

To filter by Sound Type tags:

1. Click **Sound Type** in the Filter section on the left pane of the Browser.

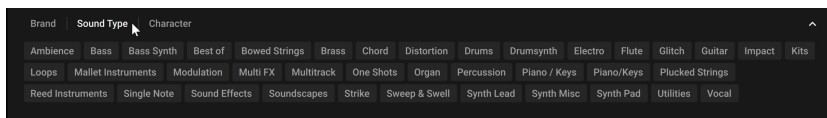

2. Click on a Sound Type tag to select it. You can select multiple Sound Type tags by pressing [Shift] + clicking. Any related NKS Subtype tags will be displayed below.

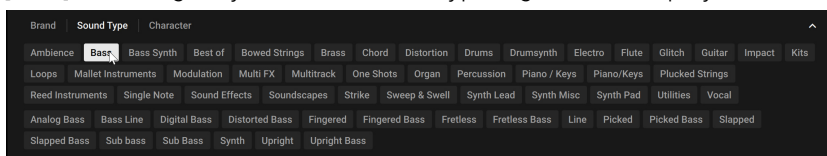

3. Click on a Subtype tag to further narrow down your search.

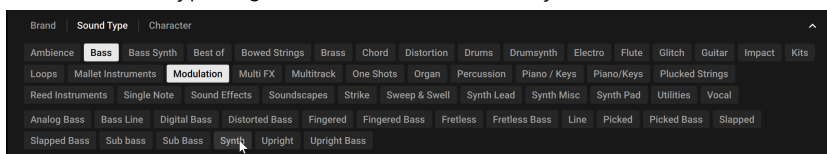

→ The presets in the Results list are filtered by the selected Filter tags. Presets carrying any of the selected Filter tags are displayed.



You can also use [command] (macOS) or [Ctrl] (Windows) + click to select multiple tags.

## Filtering by character

The Character filter provides an additional level that is independent from the Sound Type filter. These tags are used to further categorize sound characteristics that are common between different Instruments and Sound Types. This offers an additional flexible level of tagging that allows you to browse Instruments with similar characteristics to find a range of samples that meet your identified criteria.

Selecting multiple tags helps you to further refine your search. In the case of multi-selection, repeating Subtype tags are merged into a single tag. When selecting multiple tags, the last item added to the selection is also focused.

To filter by Character tags:

1. Click **Character** in the Filter section on the left pane of the Browser.

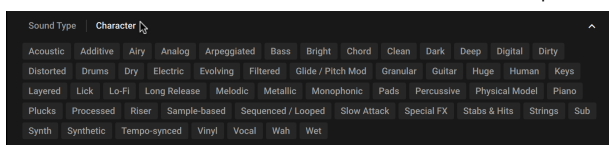

2. Click on a Character tag.

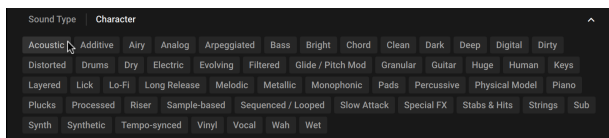

3. Press [shift] + click to select multiple Character tags.

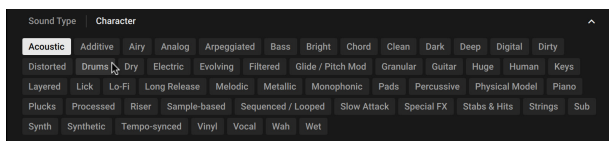

4. As you continue to select Character tags, the Results list will display only relevant presets.

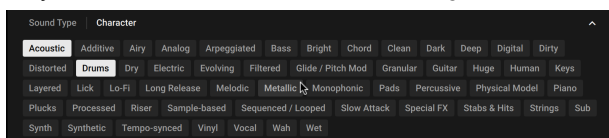

→ The presets in the Results list are filtered by the selected Filter tags. Only presets carrying all of the selected Filter tags are shown.



You can also use [command](macOS) or [Ctrl](Windows) + click to select multiple tags.

## Filtering by product

The Library tiles are located below the Sound Type and Character Filters and display all your available Kontakt libraries and custom content. Clicking a Product tile highlights the selected library and filters the Results list down to its relevant presets. You can further refine your search using the Sound Type and Character Filters, as well as the Search field.

To filter presets using the Product tiles:

1. Open the Browser.

- Select a Library from the Product tiles. The presets of the selected Library are displayed in the Results list.

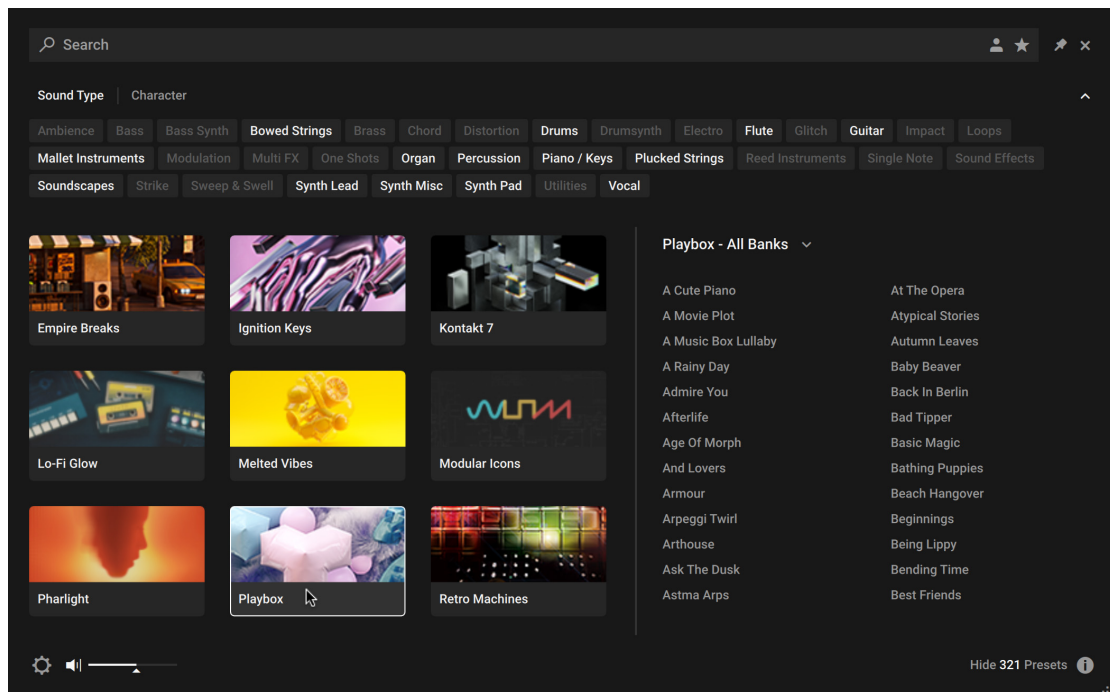

- Click the All Banks button to open the Banks menu.

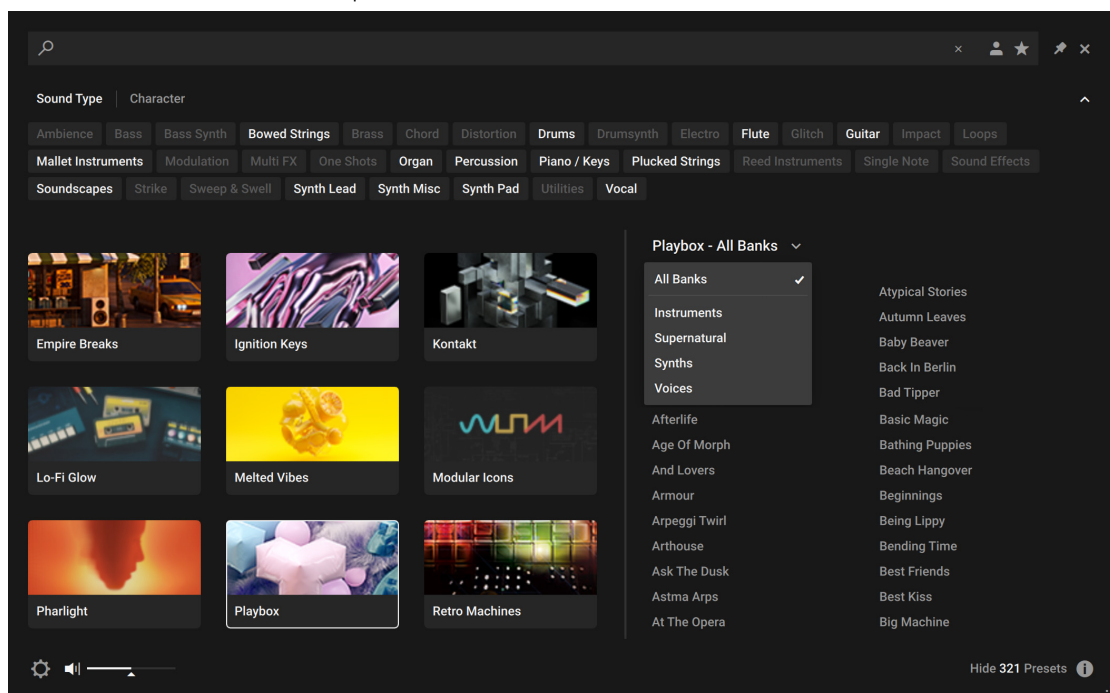



- Select from the drop-down menu to refine your search. The presets in the Result list will update accordingly.

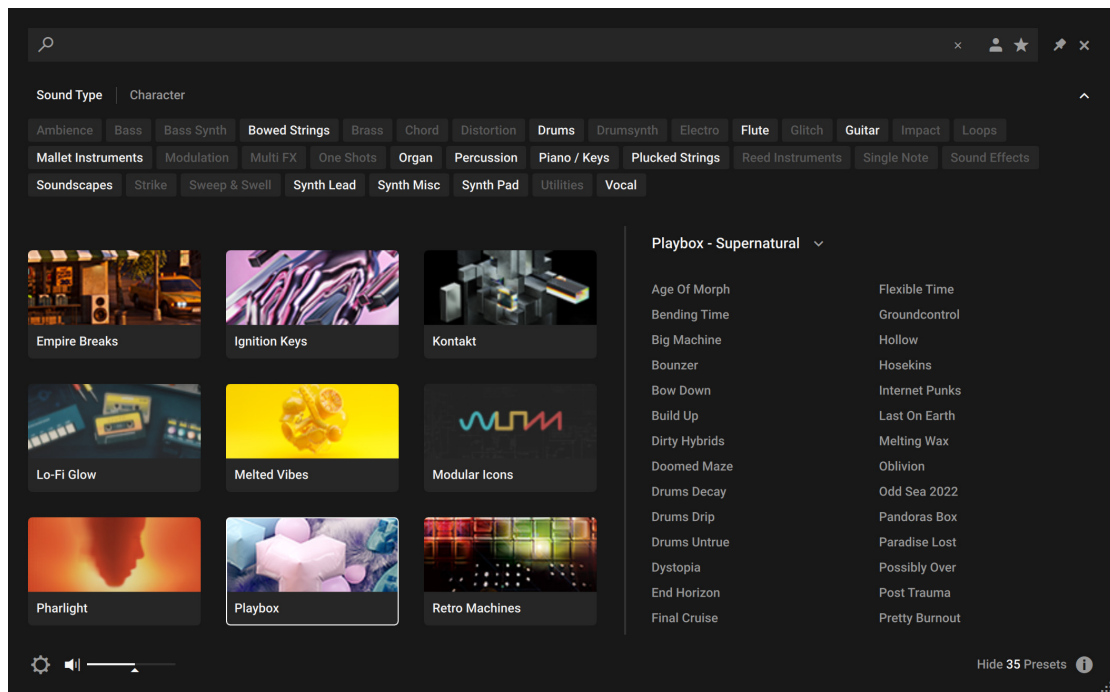

- Additionally, you can use Sound Type and Character tags to filter your search.

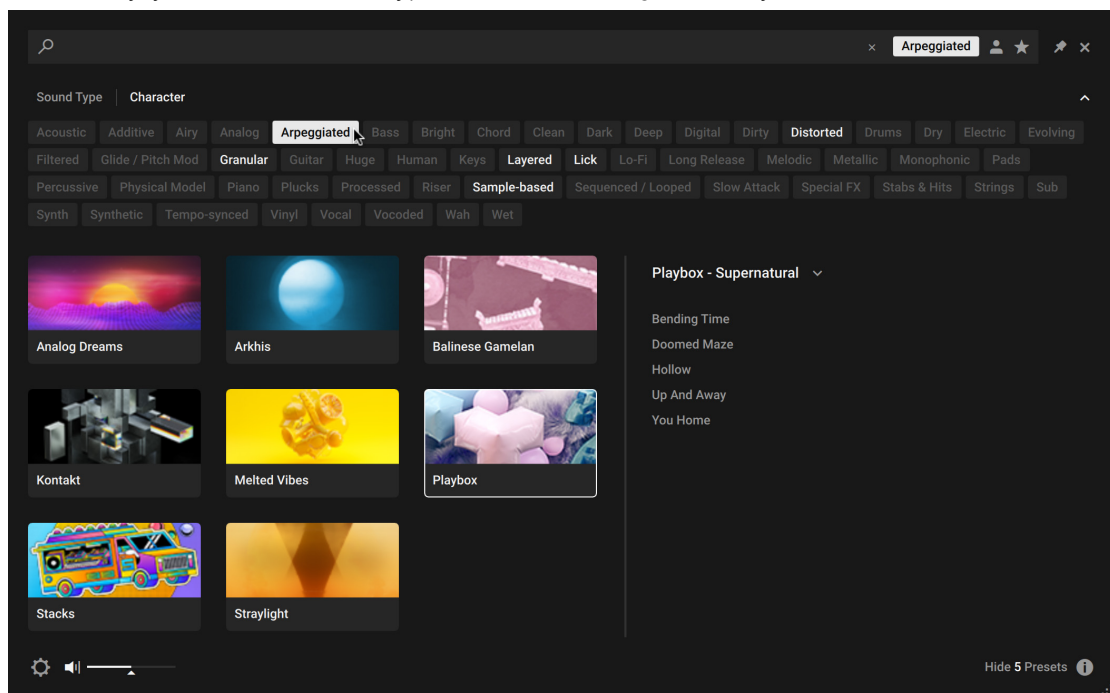

→ The presets in the Result list will update according to the selected Filter tags.



The Browser also enables you to import non-player, legacy and custom content as Library tiles. For more information, refer to [Managing imported content](#).



## Using the search field

The Search field at the top of the Browser interface allows you to filter presets with text entry. The search considers preset names, author, Filter titles, and metadata including Character and Product tags.

To filter presets using the Search field:

1. Activate the Search field by clicking it.

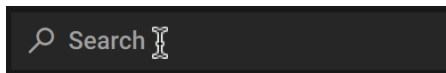

2. Enter your search terms.

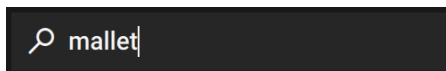

→ The Result list is filtered according to the terms entered in the Search field.

If you are browsing using Filter tags, your search will only display results according to the selected tags. Your search entry remains in the field even when the Browser is closed.

- ▶ To clear the search, click on the cross icon on the right side of the Search field.



## Using favorites

Favorites enable you to quickly find your most frequently used and enjoyed presets, and recall them at any time. By assigning Favorite tags to presets in the Results list you can create a personal collection of sounds that can be easily accessed from the Browser. Once assigned, Favorites serve as an additional filter in the Browser. You can continue to use other filters to refine your search, including the Search field. Favorites can be used for both factory and user presets.

To assign a Favorite tag:

- ▶ Click the star icon that appears when a preset is selected or hovered over.

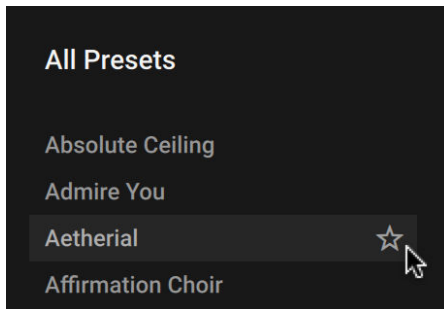

- The Favorite tag is assigned. Clicking the star again removes the tag.

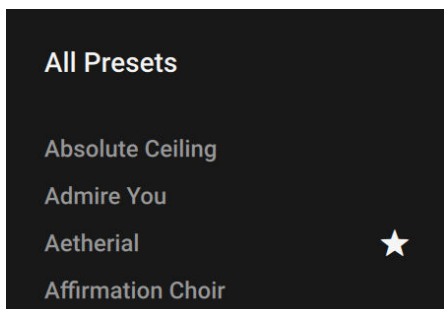

To view your Favorites in the Result list:

- ▶ Click the Favorites icon in the search field.

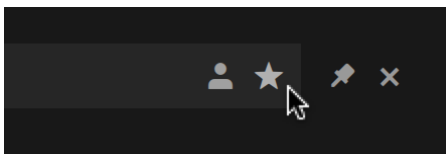

- Only presets that have the Favorite tag assigned are shown in the Result list.

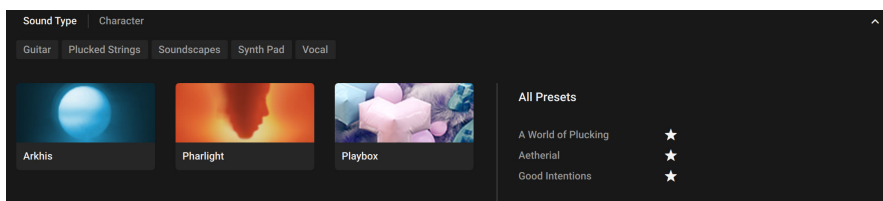

## Instrument suggestions

The **New Instruments for you** panel at the bottom of the Browser offers instrument suggestions not yet part of the local Kontakt library. These suggestions can be filtered using Sound Type & Character tags and respond to text input in the search field of the Browser. Clicking on a suggestion opens the product page of that instrument on the NI website, giving you access to more information and the ability to directly purchase it. The New Instruments for you panel can be deactivated in the Interface tab of the Options.

## Info pane

The Info Pane displays information relating to the properties and tags of the selected preset. You can also use the Info Pane to assign tags to user presets.

The Info Pane provides the following information and controls:

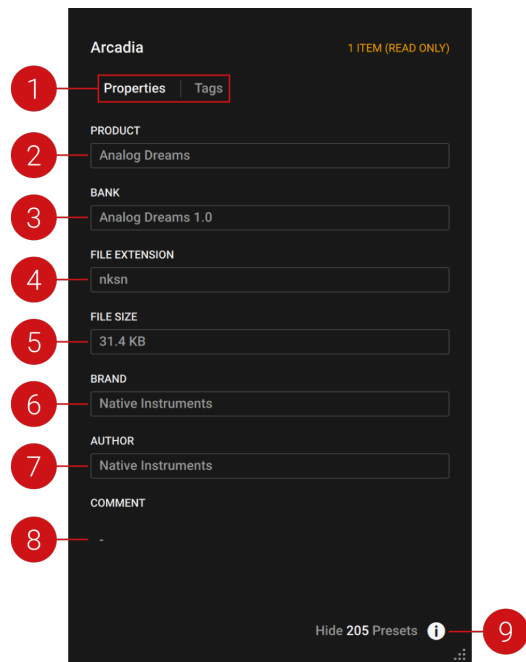

1. **Properties/Tags:** Switches the view between **Properties** and **Tags**. Click the name to display the respective information. For more information about using the **Tags** view, refer to [Managing User tags](#).
2. **Product:** Displays the name of the product that includes the preset.
3. **Bank:** Displays the name of the bank that includes the preset.
4. **File Extension:** Displays the extension of the preset's file format.
5. **File Size:** Displays the file size of the preset on disk.
6. **Brand:** Displays the name of the manufacturer that created the library.
7. **Author:** Displays the name of the author that created the preset.
8. **Comment:** Displays the optional comment embedded in the preset.
9. **Info Pane (i button):** Opens and closes the Info pane.

## Managing imported content

The Browser enables you to import Custom Libraries and User content, adding your imported content as Library tiles in the Browser. You can batch import multiple libraries in give them custom names via the alias field.

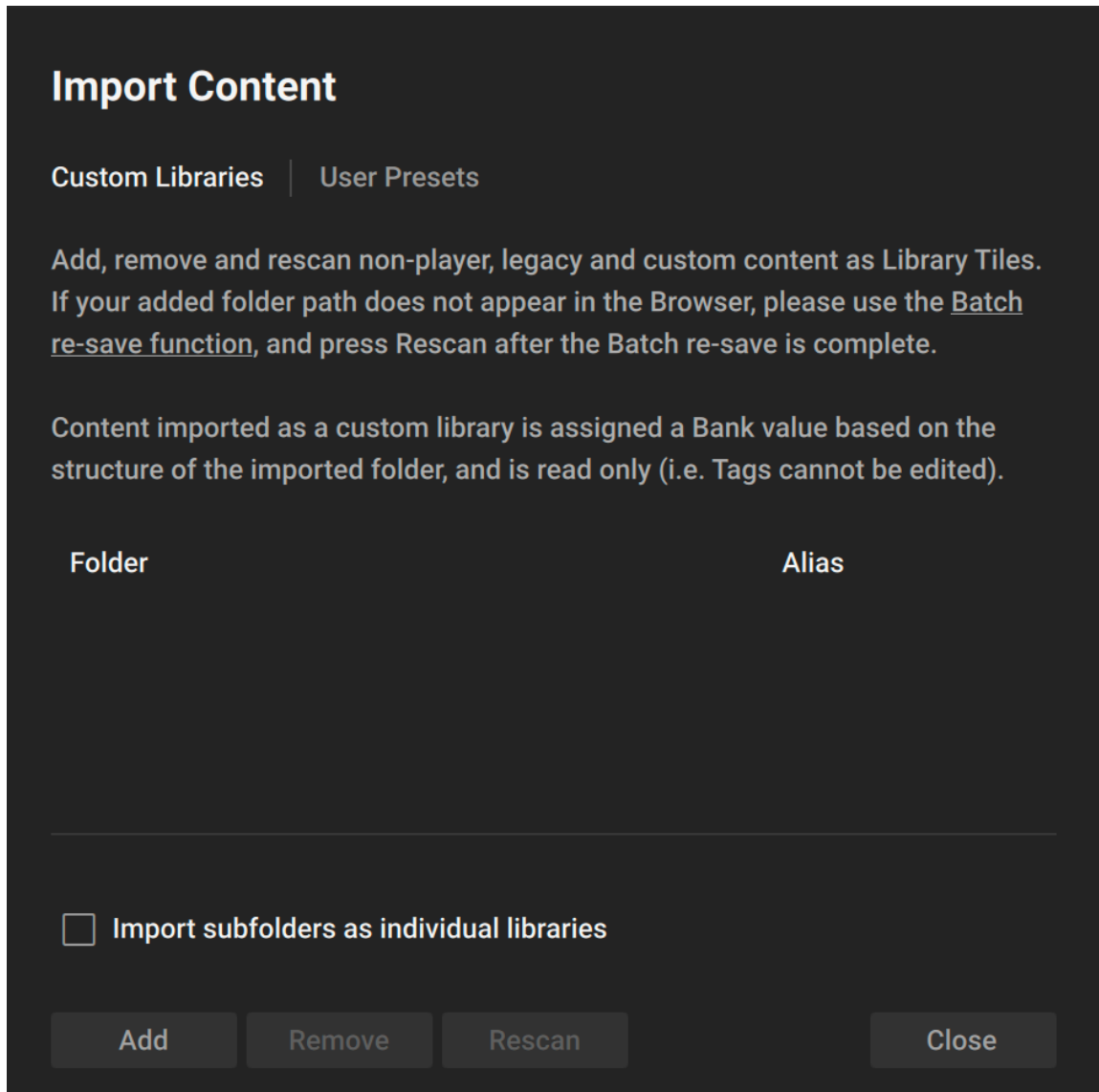

To import content:

1. Click the Browser icon in the Header to open the Browser.
  2. Click the Import Content button at the bottom left of the Browser.
  3. Select **Custom Libraries** or **User Presets**.
  4. Click **Add**.
  5. Locate the content to import and select **Open**.
- The custom content is imported and displayed as a Library tile in the Browser.

To remove custom content from the Browser:

1. Click the Import Content button, at the bottom left of the Browser.
  2. Select **Custom Libraries** or **User Presets**.
  3. Select the content in the dialog and click **Remove**.
- The custom content is removed from the Browser.

## Managing library artwork

Thumbnail icons allow you to quickly identify your Kontakt Libraries. If the library artwork does not display, use the following instructions to reset the thumbnails.

### macOS

1. Navigate to the following location on your hard drive: *Macintosh HD/Users/Shared*.
  2. Locate and delete the folder named *NI Resources*.
  3. Click **Go** in the Finder menu bar.
  4. Hold [option](macOS) or [Alt](Windows) and select the **Library** option that appears in the Go menu.
  5. Navigate to the following location: *Library/Application Support/Native Instruments*.
  6. Locate and delete the folder named *Kontakt 7*.
  7. Navigate to the *Service Center* folder in the same user *Library* folder.
  8. Locate and delete the file named **pal.db**.
  9. Empty the system trash.
  10. Open Native Access and click **Refresh**.
  11. Open Kontakt 7 in stand-alone mode.
- The Library tiles are updated and the thumbnail artwork now displays in the Kontakt Browser.

### Windows

1. Navigate to the following location on your hard drive: *C:\Users\Public\Documents*.
  2. Locate and delete the folder named *NI Resources*.
  3. Navigate to the following location on your hard drive: *C:\Users\“Username”\AppData\Local\Native Instruments*.
  4. Locate and delete the folder named *Kontakt 7*.
  5. Navigate to the following: *C:\Users\“Username”\Documents\Native Instruments\Service Center*.
  6. Locate and delete the file named **pal.db**.
  7. Open Native Access and click **Refresh**.
  8. Open Kontakt 7 in stand-alone mode.
- The Library tiles are updated and the thumbnail artwork now displays in the Browser.

## User presets

A preset recalls a previously saved sound including all individual parameter settings. Presets offer a way of exploring and saving variations of any Kontakt Instruments for easy recall. In addition to the presets included in Kontakt's extensive Factory Library, you can save, load, and import User presets. The following sections explain the basic workflows involved in using presets.

### Saving a User preset

You can save User presets to recall your favorite sounds and settings at any time, share them with others, or create backups.

### Saving a User preset using the Navigator

When using Kontakt's Default view, you can save User presets for both instruments and Tools using the Navigator in the side pane.

1. Right-click the slot in the Navigator you want to save a User preset for.

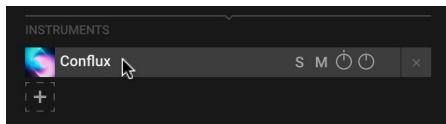

2. Click **Save Preset...** in the context menu to open the Save dialog.

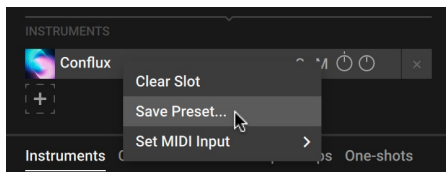

3. Enter a name for your new User preset and click **Save**. If you enter the same name as an existing User preset, you will be given the option to replace it by clicking **Overwrite**.

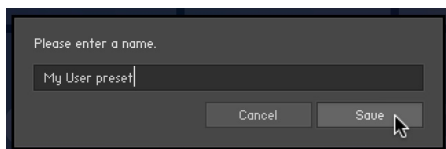

→ The User preset is saved and added to the user content in the Browser.

### Saving a User preset using the Instrument header

User presets can be saved using the Instrument Header. When a sound parameter has been adjusted, that Save button (disk icon) becomes active.

**i** If you are using Kontakt's Default view, the Instrument Header can be shown or hidden from the **View** menu in the Kontakt Header.

1. Click the Snapshot view button (camera icon) in the Instrument Header.

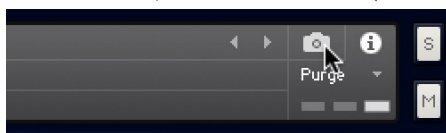

- Click the Save button (floppy disk icon) to open the Save dialog.



- Enter a name for your new User preset and click **Save**. If you enter the same of an existing User preset, you will be given the option to replace it by clicking **Overwrite**.

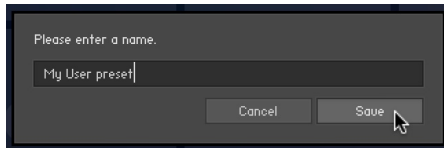

→ The User preset is saved and added to the user content in the Browser.

## User content folder

All User presets are automatically stored in the default User Content folder. You can transfer any of your User presets to another computer by copying the respective files.

The default user content folders are:

**Mac OS X:** *Macintosh HD/Users/<User Name>/Documents/Native Instruments/User Content/*

**Windows:** *C:\Users\<User Name>\My Documents\Native Instruments\User Content\*

**i** Please make sure you include your *Documents / My Documents* folder in your regular data backups.

## Loading a User preset

You can load a User preset from its respective Snapshot menu in the Instrument Header. You can also access all your User presets from one place in the new Browser.

To load a User preset:

- Open the Browser.
- Click the User content button to display all your custom presets.

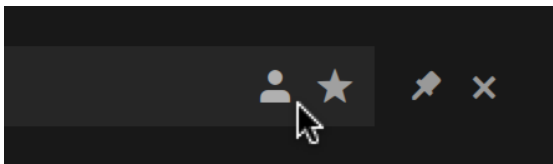

- Click a User preset from the Results list to preview the sound.
- Double-click the preset name to load it.

→ The User preset loads in Kontakt.

## Deleting a User preset

You can delete any of your User presets.

To delete a User preset:

1. Select the desired preset in the Browser.
2. Right-click and select **show in Finder / Explorer**
3. Delete the file from the disk.

→ The file is removed from the Browser on next launch of Kontakt.

## Managing User tags

You can view and edit User preset tags using the Browser's Info pane. Sound Type and Character tags can be assigned and unassigned, allowing you to browse your User presets using filtering and text search. By holding shift and selecting multiple presets, tags can be edited in bulk.

To assign tags to a User preset:

1. Click the User button to display your User presets.

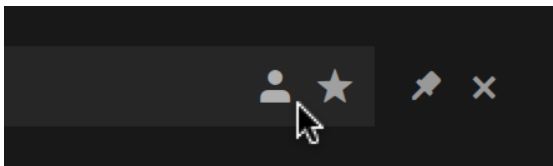

2. Select a User preset from the Results list.

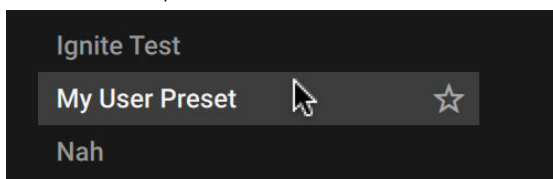

3. Click the Info pane icon.

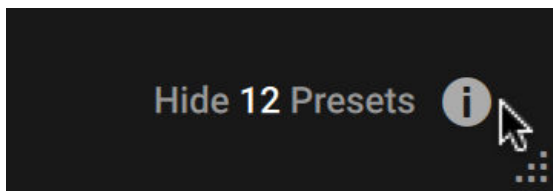

4. Select the **Tags** filter.

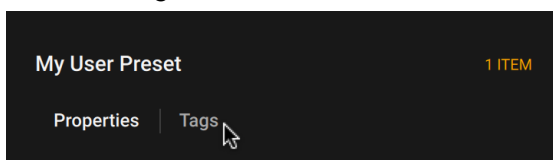

5. Select the Sound Type and Character tags that relate to your User preset.

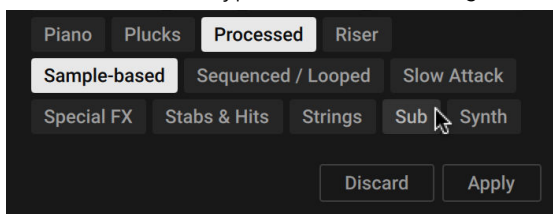



6. Click **Apply**.

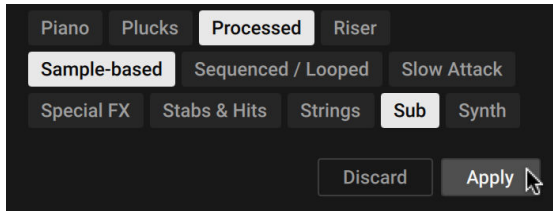

→ The selected tags are saved to the User preset file.

You can also add your own User Filter tags and assign them to a User preset in the Info Pane of the Browser.

To add a User Filter tag:

1. Select the User preset you want to assign your own User Filter tag to in the Results list by clicking on the corresponding entry.
2. Click the Info Pane button in the bottom right corner of the Results list to open the Info pane.
3. Click on the + icon under the Filter type you want to add your User Filter tag to.
4. Type in a name for your User Filter tag.
5. Press [Enter] or click anywhere in the Info pane to confirm the name and save your User Filter tag.

→ Your new User Filter tag is added and assigned to the User preset.

## 8. Instruments and Tools

Kontakt comes with built-in instruments and Tools, ready to be played as soon as you open the plugin or standalone application. **Mini Piano** offers a quick way of playing a sound, and **Leap** is a sample playground that loads Expansions or your own samples, enabling you to create exciting performances. The Tools, **Chords** and **Phrases**, are MIDI effects that transform your playing in inspiring ways.

### Mini Piano instrument

Mini Piano offers a quick way of playing a sound when you open Kontakt, even if you have not installed any other instruments. Its classic sound and immediacy make it a great session starter when you just want to lay down an idea.

Mini Piano contains the following controls:

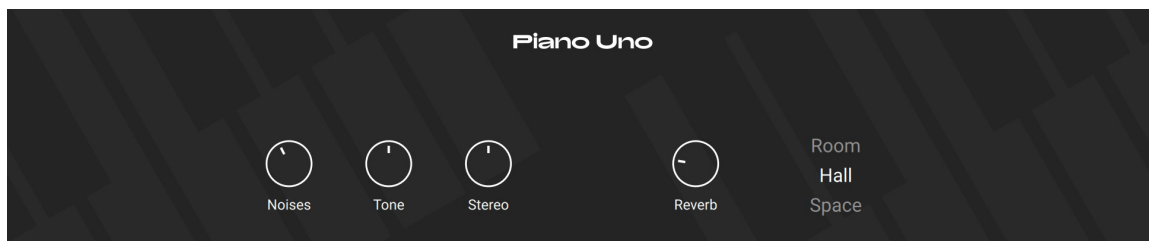

- **Noises:** Adjusts the level of noise produced by the instrument's hammer mechanism.
- **Tone:** Adjusts the timbre of the sound from dark to bright.
- **Stereo:** Adjusts the stereo width of the direct sound produced by the instrument.
- **Reverb:** Adjusts the amount of convolution reverb added to the sound.
- **Reverb type:** Selects the type of reverb by switching between three different impulse responses for the convolution reverb.
  - **Room:** A chamber with a short reverb time for a more intimate reverb effect.
  - **Hall:** A classic concert hall with a long reverb time.
  - **Space:** A supernatural reverb effect with distinct echoes and a very long reverb time.

### Leap instrument

Leap is the standard sampler in Kontakt's Default view. It lets you play exciting combinations of your loops and one-shot samples as well as curated Expansion kits. Use its engines to make each sound your own, and create exciting performances with Macro knobs and black key effects.

#### Loading and saving Leap kits

This section shows you how to [load kits and individual samples](#) in Leap and how to [save your own Leap kits](#).

#### Loading samples and kits

You can load samples and kits into Leap using various methods:

- In the [side pane browser](#) or in the [Library browser](#), double-clicking a factory or user kit from the **Leap** category will load the kit into Leap.
- In the [side pane browser](#) or in the [Library browser](#), double-clicking a sample from the **Loops** or **One-shots** category will open a new empty Leap kit and load the sample into its first sample slot.
- Dragging and dropping samples from the side pane browser's **Loops** and **One-shots** categories, or from a folder on your desktop:
  - You can drop the sample on an empty area of the Rack to open a new empty Leap and load the sample into the first slot.
  - In a Leap instance in [Single mode](#), you can drop the sample anywhere on the [Keyboard section](#) to load it into the selected slot.
  - In a Leap instance in [Group mode](#), you can drop the sample on a specific key of the [Keyboard section](#) to load it into that slot. You can also drag and drop multiple samples at once: The first sample will be loaded into the target slot and the remaining samples into the following slots.
  - In a Leap instance with the [Edit page](#) open, you can drop the sample on the Waveform to load it into the selected slot.
- In a Leap instance in [Group mode](#), you can [Ctrl]-click the desired key in the [Keyboard section](#), select **Browse** from the [context menu](#), and choose a sample to load it into that slot.



In any case, loading a sample into a slot in Leap will replace the sample previously in that slot (if any).

You can also start with an empty Leap kit by double-clicking in the empty space of the Rack, or by selecting **New Leap preset** from the File menu in Kontakt's [Header](#). You can then fill the Leap kit with samples using any of the methods listed above.

## Saving your own kits

You can save the current state of the kit in Leap as a user kit:

1. In the Navigator at the top of the [side pane](#), right-click the Leap's slot to open the context menu.
2. Select **Save Preset...** from the context menu.
3. Enter a name in the dialog and click **Save** to confirm.

→ The kit is saved as a **.nkl** file on your computer and it will appear in your user content within the **Leap** category, both in the side pane browser and in the Library browser.

If your kit is a modified version of a factory kit from a Leap Expansion, it will appear in the user content of that Leap Expansion. If you have instead created the kit from scratch by opening an empty Leap instance and filling it with samples, your kit will appear in the user content of a dedicated Leap Expansion named **Custom Kit**.

## Leap overview

Leap contains the following main elements and controls:

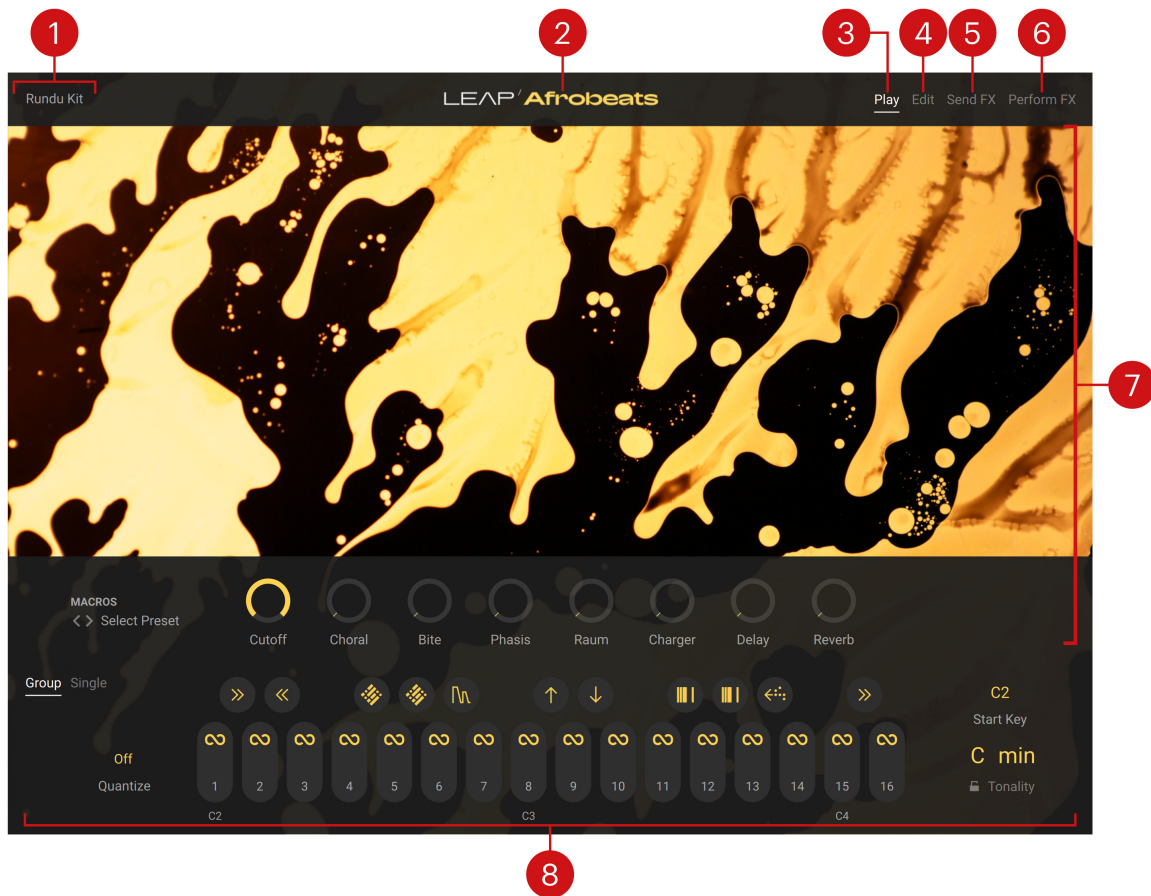

1. **Preset name:** Shows the name of Leap preset currently loaded.
2. **Expansion name:** Shows the name of the Leap Expansion from which the preset is originating. If you have modified a factory preset and save it as a user preset, this user preset will still show the name of the original Leap Expansion. If you create a Leap preset from scratch, it will belong to the dedicated **Custom Kit** Expansion.
3. **Play:** Opens the **Play page**, depicted above. This is the default page that appears when you load Leap in Kontakt.
4. **Edit:** Opens the **Edit page**, where you can configure in detail the sound and the playback behavior of each sample in the loaded kit.
5. **Send FX:** Opens the **Send FX page**, which lets you adjust the parameters of the two available send effects.
6. **Perform FX:** Opens the **Perform FX page**, which lets you assign the desired Perform effects to the black keys on your keyboard and adjust their parameters.
7. **Central area:** This is the biggest part of the interface and it shows the various pages. In the picture above, the central area shows the **Play page**, which includes an artwork specific to each Expansion and the **Macros** below.
8. **Keyboard:** Lets you visualize and modify the key mappings used to trigger the samples and the Perform effects from your MIDI keyboard. You can also switch your keyboard between **Group** and **Single** modes. For more information, refer to **Keyboard section**.

## Macros

The Macros are a set of eight controls displayed on the Play page below the artwork of the Leap Expansion:

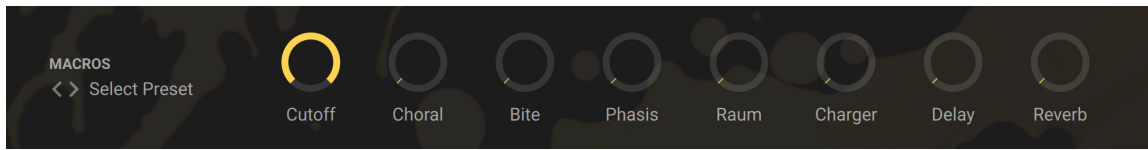

- **Macro preset selector:** Selects a set of eight Macros. You can click the preset name to open a menu where you can select another Macro preset, or you can click the little left and right arrows to quickly switch to the previous or next preset from the list. Each Leap Expansion provides its own Macro presets. The Macro preset selector will collect the Macro presets available in every Leap Expansion installed on your computer.
- **8 Macro controls:** Adjust the various effects available in the selected set. The first six Macros adjust six curated effects made for live performance. The last two Macros adjust your kit's global send levels to the [delay and reverb send effects](#), respectively.



The eight Macros are also available on the first page of the Performance view on the Kontrol S-Series keyboards.



The last two Macros (Delay and Reverb) control the global send levels for your kit. You can also configure individual send levels for specific samples in your kit by using the **Delay** and **Reverb** controls in the [Master section](#) located in the Sound panel of the Edit page.

## Keyboard section

The Keyboard section is always visible at the bottom of the Leap interface. It represents the key mappings on your MIDI keyboard, lets you switch Leap between Group mode and Single mode, and provides important keyboard-related settings.

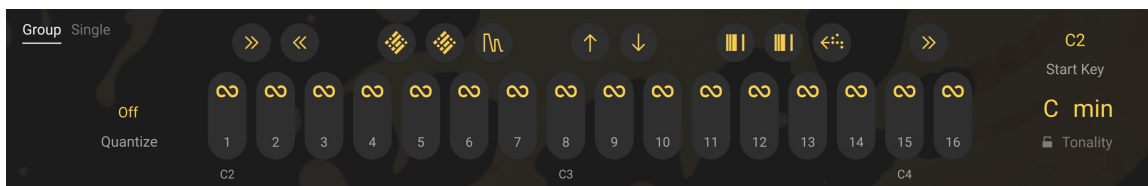

In the top left corner of the Keyboard section, you can choose from the two operating modes available in Leap:

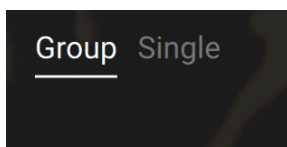

- **Group** (default mode): In Group mode you can play the entire kit (up to 16 samples) with the 16 white keys (by default from C2 to D4), and use the 11 black keys in between to trigger the Perform FX. For example, this mode is well suited for drum kits or loop sets. For more information, refer to [Group mode](#).
- **Single:** The Single mode allows you to play one sample from the kit chromatically on all the keys (both white and black). For example, this mode can be handy for samples of melodic instruments. For more information, refer to [Single mode](#).

## Group mode

The Group mode is the default Leap operation mode. In Group mode you can play the entire kit (up to 16 samples) with the white keys and use the black keys to trigger the Perform FX. Each sample is played monophonically and all 16 samples are by default time-stretched and tuned to play well together. For example, this mode is well suited for drum kits or sets of rhythmic loops.

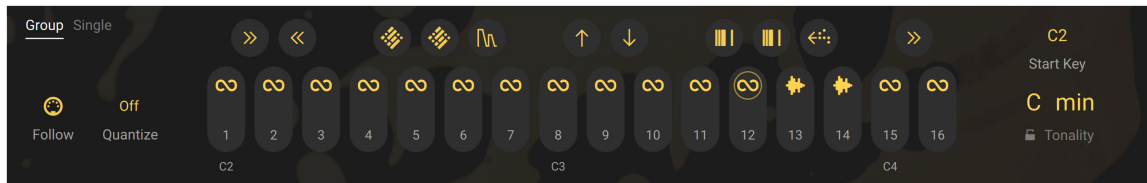

In Group mode the Keyboard section contains the following elements and controls:



- **Group/Single Mode switch:** Switches between the Group mode and the [Single mode](#).
- **Follow:** Available only when the [Edit page](#) is displayed. If **Follow** is turned on, you can select each sample by playing its corresponding key on your keyboard. For example, this can be useful when adjusting the same parameter for multiple samples: you can quickly select the samples in a row using your keyboard, and for each sample adjust the desired parameter.
- **Quantize:** Quantizes the start time of the triggered samples to the next time division. By clicking the displayed value you can select another time division to which the incoming notes should be quantized. Or you can deactivate the input quantization by selecting **Off** from the menu. This input quantization applies both to incoming MIDI notes and to your clicks on the sample slots, but does not affect the black keys (Perform effects) nor the Single mode. For the quantization to work, the playback must be active in your DAW (if Kontakt is running as a plug-in) or in the Master Editor (if Kontakt is running as a standalone application).
- **Black keys** (upper row): Each key represents a Perform effect. The effect is turned on as long as you hold the key depressed (either in this Keyboard section or on your MIDI keyboard). You can configure the Perform effect assigned to each key on the [Perform FX page](#).
- **White keys** (lower row): Each key represents a sample slot. Each sample can be triggered by clicking the slot or pressing the corresponding key on your MIDI keyboard. The slots are numbered from **1** to **16**. As a reminder, the first key of each octave is indicated below the keys (by default **C2**, **C3**, and **C4**). Various icons and actions are available on the slots depending on their content and playback mode.
- **Start Key:** Adjusts the lower end (or start key) of the key range used by Leap. This allows you to adapt Leap to the physical key range available on your MIDI keyboard. You can set the Leap range to start either on the C or on the F key in any octave from 0 to 4.
- **Tonality:** Specifies a global tonality for both Group mode and Single mode. In Group mode, the samples for which the **Global** switch is turned on in the [Tuning section](#) of the Engine panel will be transposed to match this global tonality. You can adjust the tonality using two menus: the **Key menu** on the left sets the root note of the scale, and the **Mode menu** on the right selects its scale mode between **Major** and **Minor**. Click either menu to select the desired value.
- **Tonality Lock:** When the Lock is active, the **Tonality** values remains untouched when you load another kit.

## Icons and actions on the sample slots

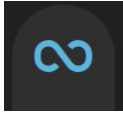
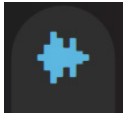
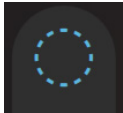
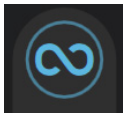
In Group mode the **slot icons** indicate its contents and states:

Icon	Description
	Slot containing a looped sample ( <b>Loop</b> switch turned on in the <a href="#">Playback section</a> of the Engine panel on the <a href="#">Edit page</a> ).
	Slot containing a one-shot sample ( <b>Loop</b> switch turned off in the <a href="#">Playback section</a> of the Engine panel on the <a href="#">Edit page</a> ).
	Empty slot.
	Selected slot (indicated by the circle). This icon is visible only on the <a href="#">Edit page</a> and it is displayed in addition to the loop/one-shot/empty icon.
	Playing slot. The progress bar is displayed in addition to the other icons. When the sample is triggered, the bar starts from the top and runs clockwise along the slot border. A full cycle around the slot corresponds to a full play range or loop range of the sample.

In addition, in Group mode the following **slot actions** are available:

- Clicking the icon of the selected slot switches between the Play page and the Edit page.
- Clicking the icon of an unselected slot selects the slot and opens its Edit page.
- Clicking a slot outside its icon triggers the sample.
- If the Edit page is open and **Follow** is on, clicking a slot outside its icon triggers the sample and selects the slot, the slot details showing up in the Edit page above.
- When hovering over a slot with the mouse, a little keyboard icon appears below the slot: Clicking the keyboard icon selects this slot and directly switches to Single mode so that you can play that sample chromatically.

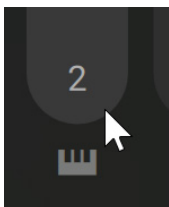

- [Ctrl]-clicking (Windows) or [command]-clicking (Mac) a slot outside its icon opens a context menu with the following editing commands:

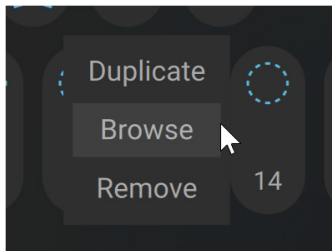

- **Duplicate:** Copies the sample and all its settings into the next free slot on the right. The duplicate is automatically selected and its [Edit page](#) opens up. If there is no free slot on the right, nothing happens.
- **Browse:** Opens a **Locate Sample** dialog that lets you browse your file system and select another sample. When you click **Open** in the dialog, the selected sample is loaded into the slot, replacing its previous sample, if any.
- **Remove:** Removes the sample from the slot, leaving the slot empty.

## Single mode

In Single mode you can play the sample from the selected slot chromatically across the entire key range of your external keyboard.

In Single mode the Keyboard section contains the following elements and controls:

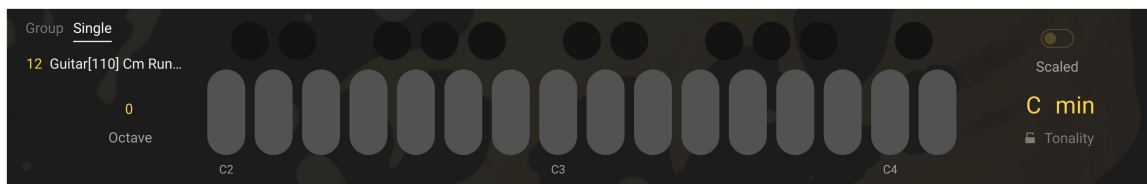

- **Group/Single Mode switch:** Switches between the [Group mode](#) and the Single mode.
- **Sample info:** Shows the number (**1 – 16**) of the selected slot and the name of its sample.
- **Octave:** Transposes the key range available in the Keyboard section by octaves (from -2 to +3 octaves). This key range is indicated by a different color on Kontakt's on-screen keyboard and on the Light Guide of the Kontrol S-Series keyboards.
- **Black and white keys:** Trigger the sample at different pitches. As a reminder, the first key of each octave is indicated below the white keys (by default **C2**, **C3**, and **C4**).
- **Scaled:** When activated, all the played keys will be quantized to the scale defined by the **Tonality** control: If you play a note outside that scale, it will be quantized to the nearest note within the scale.
- **Tonality:** Specifies a global tonality for both Group mode and Single mode. In Single mode, this global tonality serves as a reference when quantizing the pitch of the played notes using the **Scaled** switch. You can adjust the **Tonality** parameter using two menus: the **Key menu** on the left sets the root note of the scale, and the **Mode menu** on the right selects its scale mode between **Major** and **Minor**. Click either menu to select the desired value.
- **Tonality Lock:** When the Lock is active, the **Tonality** values remains untouched when you load another kit.

## Edit page

The Edit page lets you adjust the settings of the sample in the selected slot in detail.



- ▶ Click **Edit** at the top right of the instrument to display the Edit page.

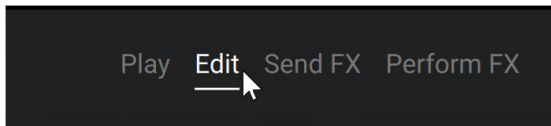

The Edit page contains the following elements:



1. **Sample info:** Shows the sample name, length, tempo, and key.
2. **Grid settings:** Adjust the beat grid, which defines the position of the beats in the sample. The beat grid can be used, for example, to position the loop markers precisely on the beats. For more information, refer to [Grid settings](#).
3. **Stripe:** Shows a minimized version of the sample waveform. The Stripe also indicates the position of the beat grid of the white start/end markers and green loop markers (if any). The Stripe provides a frame defining the part of the sample that is displayed in the Waveform below. You can click the left or right end of the frame and drag it horizontally to shrink or extend the displayed portion. You can also click inside the frame and drag your mouse horizontally to move the displayed portion across the timeline, or vertically to zoom in/out in the sample waveform. A double-click anywhere in the Stripe will reset the frame and show the entire sample.
4. **Waveform:** Shows a detailed version of the sample waveform. The time grid is indicated by vertical dark gray lines. A pair of white markers labeled **S** and **E** define the start and end points of the playback range, respectively. The portions of the waveform outside the playback range are grayed out. When the sample is triggered, the playback starts from the **S** marker. If the looped playback is off, the playback will stop on the **E** marker. If the looped playback is on, a pair of green markers define the loop range (the sample end marker is then ignored). You can move all these markers to the desired positions by clicking them and dragging the mouse horizontally.
5. **Sample settings:** Lets you adjust the settings of the sample in detail. The sample settings are split into two panels: the settings on the [Engine panel](#) affect the playback engine, while settings on the [Sound panel](#) control the sound character of the sample.

6. **Voice settings:** Adjust the polyphony of the selected sample. The Voice settings affect only the **Single mode**. In Single mode, the selected sample can be played back multiple times simultaneously, for example by pressing multiple keys at the same time on your keyboard. Each time that the sample is played, it uses one “voice.” The **Voices** selector specifies the maximum number of voices (from 1 to 16) available at any time for the sample playback, that is, it defines how many times the sample can be played back simultaneously. If this maximum number of simultaneous voices has been reached and the sample is triggered one more time, the oldest sounding voice will be cut to make room for the new one. You can adjust the **Voices** value by clicking the value and dragging your mouse vertically, or by clicking the little up and down arrows next to it. The **Mono** button lets you directly switch to a maximum of one single voice only. In Group mode, the Voice settings are grayed out and inactive.

## Grid settings

The grid settings let you configure the beat grid, which defines the position of the beats on the timeline. Once the beat grid has been set, you can move the sample’s start, end, and loop markers precisely onto the beats. The beat grid is displayed in the Stripe and in the Waveform using vertical dark gray lines. As you change the grid settings, the beat grid is automatically updated in both displays.

The grid settings contain the following elements and controls:



- **GRID:** Selects the mode used to set the beat grid. Selecting **Off** deactivates the grid completely. In **Fix** mode the grid uses a fixed time duration between beats throughout the sample. In **Auto** mode Kontakt sets the beats automatically by detecting the transients in the sample. If you have loaded a REX file, an additional **REX** mode lets you use the grid information stored in the REX file.
- **WIDTH** (grid in **Fix** mode only): Selects the duration between beats, measured in fractions of the sample duration according to its playback speed. The available values go from **1/1** to **1/64**. For example, selecting **1/8** will create by default 8 beats across the sample.
- **THRESHOLD** (grid in **Auto** mode only): Adjusts the sensitivity of the transient detection. Increasing **THRESHOLD** will result in detecting more beats.
- **SNAP TO:** Selects what the start, end, and loop markers should snap to when you move them across the sample. Selecting **Off** deactivates snapping completely. Selecting **Grid** will let the markers snap to the beats, which allows rhythmic samples to start and loop perfectly on the beat. Selecting **Zero-X** will let the markers snap to the nearest position where the audio signal crosses the zero value, which reduces possible clicks between samples or at the looping transition.

**i** When **Sync** is on in the **Tempo section** of the Engine panel, the number of beats appearing in the Waveform will depend not only on the **Width** value but also on the **Speed** value (also in the Tempo section): For example, if **Speed** is set to **x 2** the sample will play at double speed, effectively playing twice in the time of the original sample: As a result, the **Width** value of **1/8** will create 8 beats over two samples, which makes only four beats across one sample: The Waveform, which always shows one sample, will display only these four beats.

## Engine panel

The Engine panel lets you choose a playback engine and configure the playback details for the selected sample.

- ▶ Click **Engine** at the bottom left of the Waveform to display the Engine panel.

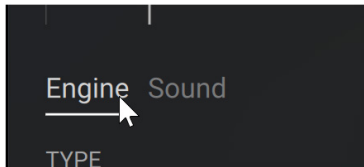

The Engine panel contains the following sections:

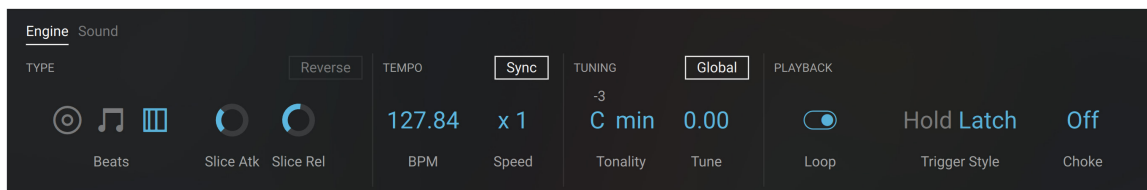

- **Type section:** Selects a playback engine and configures its dedicated parameters. Refer to [Type section](#) for more information.
- **Tempo section:** Adjusts the tempo-related settings of the sample. Refer to [Tempo section](#) for more information.
- **Tuning section:** Adjusts the tonality of the sample. Refer to [Tuning section](#) for more information.
- **Playback section:** Adjusts how the sample should be played. Refer to [Playback section](#) for more information.

### Type section

The first control in the Type section of the Engine panel is the **Engine selector**, which lets you select the playback engine to use with the selected sample:

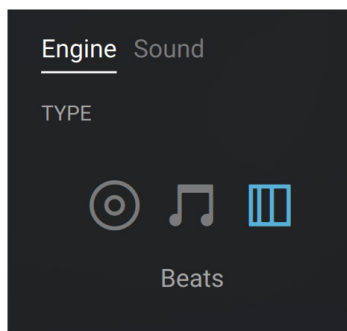

The remaining parameters in the Type section will vary depending on the selected engine: [Classic](#), [Melody](#), or [Beats](#).

### Classic engine

The Classic engine offers true old school polyphonic synth vibes. With this engine the sample cannot be synchronized with the tempo. Based on Kontakt's original Sampler engine, the Classic engine provides the following controls:

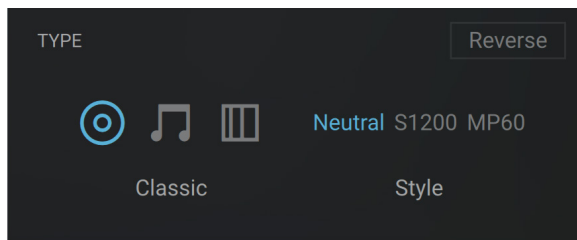

- **Reverse:** Plays the sample in reverse. Note that when this button is activated, the playback will start at the end marker (**E**) of the sample, so if there are a few seconds of silence at the end of the sample, the sound will be delayed.
- **Style:** Selects from three engine modes. The **Neutral** mode is the default, unaltered engine mode. The **S1200** and **MP60** are two “vintage machine” modes. They emulate two classic samplers of the 80s, degrading the playback quality of the sample and changing how Kontakt changes the pitch and basic handling of the sample playback engine.

### Melody engine

The Melody engine is based on Kontakt’s Time Machine Pro engine. This engine allows a high quality real-time time-stretching of your sample without affecting its pitch. It provides the following controls:

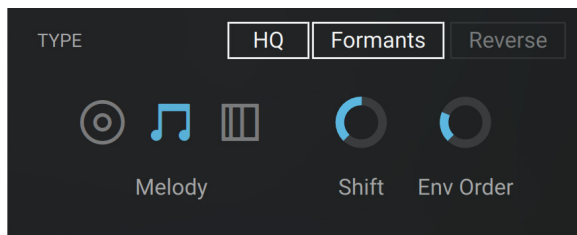

- **Reverse:** Plays the sample in reverse. Note that when this button is activated, the playback will start at the end marker (**E**) of the sample, so if there are a few seconds of silence at the end of the sample, the sound will be delayed.
- **HQ:** Turns the high quality mode on or off. When **HQ** is on, you can adjust the advanced parameters described below.
- **Formants:** When this is on, the formants are preserved when pitch-shifting or time-stretching the sample.
- **Shift** (Formant Shift): Sets the spectral envelope’s shift factor. The default is set to **100 %**, which works fine for most material. This spectral shift is performed before the overall pitch shifting.
- **Env Order** (Envelope Order): Sets the order of the spectral envelope (formant) estimation. The default is set to **128**, which works fine for most material. If the input audio is really high pitched the order should be lowered, similarly, if the input audio is low pitched the value should be raised.

**i** The Melody engine uses more CPU resources than the other engines.

### Beats engine

The Beats engine is based on Kontakt’s Beat Machine engine. This engine allows automatic slicing of your sample for tempo-synchronized playback, which makes it well-suited for rhythmic materials like drum loops. It provides the following controls:

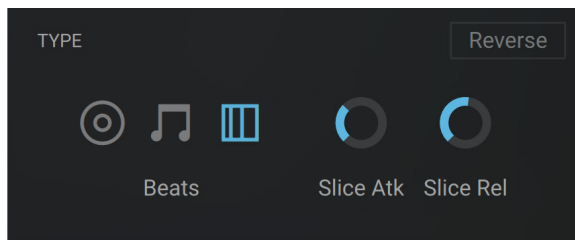

- **Reverse:** Plays the sample in reverse. Note that when this button is activated, the playback will start at the end marker (**E**) of the sample, so if there are a few seconds of silence at the end of the sample, the sound will be delayed.
- **Slice Atk** (Slice Attack): Since slicing can occur at spots in your sample that can cause clicks when played back in isolation, slices are being crossfaded into each other instead of just played back in succession. This control adjusts the attack time of the crossfade envelopes. As large values can weaken your transients, you should generally adjust this control to the lowest possible value that just avoids clicking.
- **Slice Rel** (Slice Release): Adjusts the release time of the crossfade that occurs between slices.

### Tempo section

When a sample is loaded into Leap, its tempo is automatically detected. This tempo is the foundation of the tempo synchronization. The Tempo section of the Engine panel lets you adjust the detected tempo and define how this tempo should be used. The section contains the following controls:

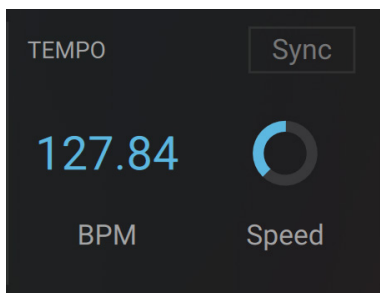

- **BPM:** Lets you manually correct the tempo of the sample. Most of the time you will not have to use it, since the tempo is detected automatically. The **BPM** control rather serves as a backup if the tempo detection algorithm does not provide satisfying results. You can adjust the tempo by clicking the displayed value and dragging your mouse vertically. Holding [Shift] while dragging allows for finer adjustments. Alternatively you can double-click the value and enter a new value using your computer keyboard.
- **Sync** (Melody and Beats engines only): When this is on, the sample's playback speed is changed to match Kontakt's global tempo (which is the tempo of your DAW if Kontakt is running as a plug-in).
- **Speed** (Melody and Beats engines only): If **Sync** is on, the **Speed** control lets you double or halve the playback speed of the sample, which can help quickly correct the detected tempo. If **Sync** is off, the **Speed** control lets you freely adjust the playback speed of the sample relative to its original tempo as set by the **BPM** control.

**i** If the Classic playback engine is selected in the [Type section](#) on the left, the sample cannot be synchronized to the tempo of your DAW, and the **Sync** and **Speed** controls are grayed out and inactive. To make them available, first switch to another playback engine.

## Tuning section

When a sample is loaded into Leap, its tonality is automatically detected. This tonality is the foundation of the tonality matching between samples. The Tuning section of the Engine panel lets you adjust the detected tonality. It contains different controls depending on whether Leap is in Group mode or in Single mode.

In **Group mode** the Tuning section contains the following controls:



- **Tonality:** Lets you manually correct the tonality of the sample. Most of the time you will not have to use it, since the tonality is detected automatically. The **Tonality** control rather serves as a backup if the tonality detection algorithm does not provide satisfying results. You can adjust the **Tonality** parameter using two menus: the **Key menu** on the left sets the root note of the scale, and the **Mode menu** on the right selects its scale mode between **Major**, **Minor**, and **No Mode**. Click either menu to select the desired value. If you select **None** from the left Key menu, no tonality is assigned to the sample, and no tonality matching can be applied.
- **Global:** When this is on, the sample is transposed to match the global **Tonality** value defined in the [Keyboard section](#). The amount of transposition is indicated by a number appearing above the sample's own **Tonality** value.
- **Tune:** Detunes the sample by the displayed value, measured in semitones. To change the value, click it and drag your mouse vertically, or click the little up/down arrows next to it. By holding [Shift] as you drag the mouse or click the arrows, you can adjust the value in much finer increments (cents).

In **Single mode** the Tuning section contains the following controls:

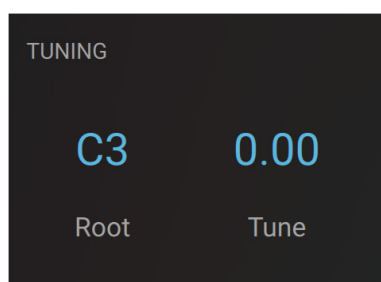

- **Root:** Defines the key triggering the original, unpitched sample. All other keys will trigger a transposed version of the sample corresponding to their pitch relative to the root key.
- **Tune:** Detunes the sample by the displayed value, measured in semitones. To change the value, click it and drag your mouse vertically, or click the little up/down arrows next to it. By holding [Shift] as you drag the mouse or click the arrows, you can adjust the value in much finer increments (cents).

## Playback section

The Playback section of the Engine panel specifies the playback behavior of the sample. The section contains the following controls:

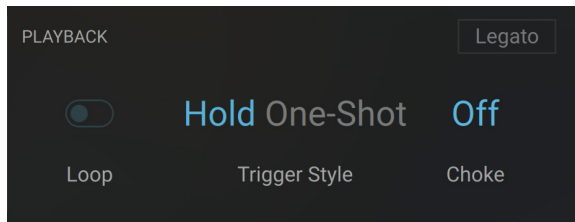

- **Loop:** Turns the looped playback on or off. When **Loop** is on, the **Waveform** shows a pair of green loop markers that let you define which part in the sample should be played in loop. In Group mode, the looped state of each sample is indicated by a dedicated icon on its sample slots in the **Keyboard section**.
- **Trigger Style:** Defines the playback behavior when you release the key. When **Loop** is off, you can select between **Hold** (the sample stops playing when you release the key) and **One-Shot** (the sample plays until its end marker even if you release the key). When **Loop** is on, you can select between **Hold** (the loop stops playing when you release the key) and **Latch** (the loop keeps playing until you press the key another time).
- **Choke** (Group mode only): Assigns the sample to a particular choke group. A choke group is a set of “mutually exclusive” samples: Within a choke group, each newly triggered sample will cancel an older sample still playing, so that these samples would never play together. Four choke groups are available in each kit. You can assign the desired samples to a choke group by selecting the same **Choke** value for each of them. You can adjust the **Choke** value by clicking it and dragging your mouse vertically, or by using the little up and down arrows next to it.
- **Wrap / Ping Pong selector** (Classic engine only): When Loop is on, a **Wrap / Ping Pong** selector appears and lets you choose between two looping variants. If you select **Wrap** (default setting), as the playback reaches the loop end it will jump back to the loop start and continue from there. If you select **Ping Pong**, the loop will play alternately back and forth.
- **Legato** (Melody engine only): When **Legato** is on, if a previous sample is still playing the playback will not start from the sample’s start marker, but instead it will follow the play position of the previous sample. If no other sample is playing, the playback will start as usual from the sample’s start marker.

## Sound panel

The Sound panel lets you configure the audio processing that will affect the sound of the selected sample.

- ▶ Click **Sound** at the bottom left of the Waveform to display the Sound panel.

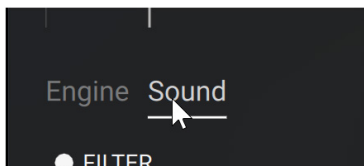

The Sound panel contains the following sections:

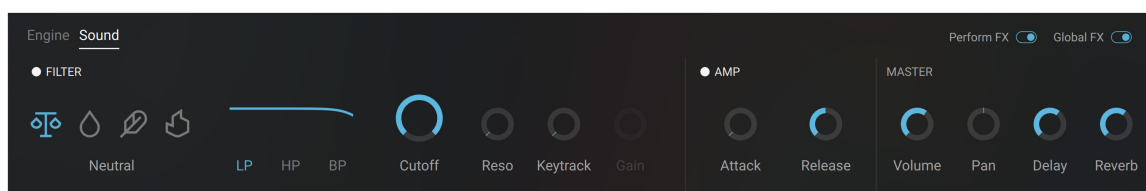

- **Filter section:** Adjusts a filter applied to the sample. Refer to **Filter section** for more information.

- **Amp section:** Adjusts the amplification stage. Refer to [Amp section](#) for more information.
- **Master section:** Adjust the output stage. Refer to [Master section](#) for more information.

In the top right corner, the Sound panel provides two additional switches:

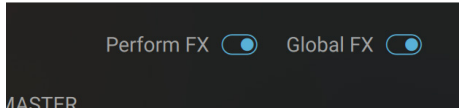

- **Perform FX switch:** This switch is on by default. If you turn it off (switch to the left), the sample will not be processed by the [Perform effects](#). For example, with this switch you can prevent a pad sound or texture from being processed by a time-synchronized Perform effect that might only be suitable for the drum samples of your kit.
- **Global FX switch:** This switch is on by default. If you turn it off (switch to the left), the sample will not be processed by the global effects controlled using the [Macros](#).

## Filter section

The Filter section of the Sound panel contains the following controls:

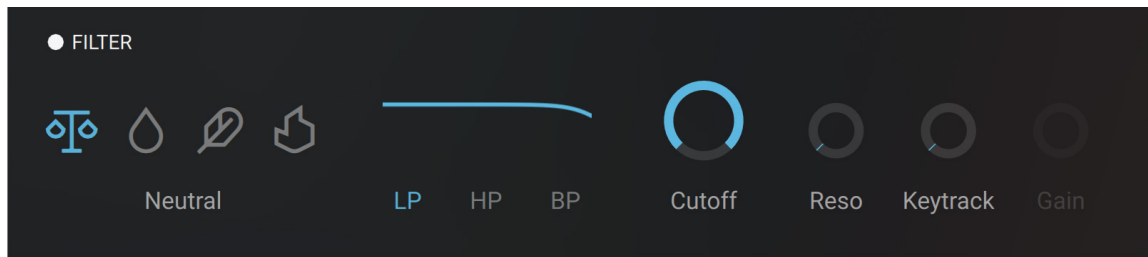

- **FILTER On/Off:** Turns the filtering of the sample on or off.
- **Filter Flavor selector:** Selects from the following filter flavors:
  - **Neutral:** Clean characteristic that can be used for all kinds of audio signals. This flavor uses Kontakt's State Variable (SV) filters in their 2-pole variant, which attenuates frequencies below/above the cutoff at a rate of -12 dB/octave.
  - **Juicy:** First choice for synthetic sounds, but can work well on any signal. This flavor uses Kontakt's Ladder filters in their 4-pole variant, which attenuates frequencies below/above the cutoff at a rate of -24 dB/octave.
  - **Mild:** Works best on full loops or drums. This flavor uses Kontakt's Adaptive Resonance (AR) filters, which follow the amplitude of the input signal and adjust the resonance accordingly. At higher input levels, the resonance will reduce, and at lower levels it will increase, this avoids unpleasant peaks.
  - **Aggressive:** More aggressive synthesizer filter design. This flavor uses Kontakt's Daft filters, which have been adapted from Massive. These filters have a 2-pole response, which attenuates frequencies below/above the cutoff at a rate of -12 dB/octave.
- **Frequency Response display:** Shows an overview of the frequency response resulting from your current filter settings.
- **Filter Type selector:** Selects from the following filter types:
  - **LP (Lowpass):** Attenuates signals above the cutoff frequency, allowing low frequency signals to pass through.
  - **HP (Highpass):** Attenuates signals below the cutoff frequency, allowing high frequency signals to pass through.
  - **BP (Bandpass, not available for the Aggressive filter flavor):** Attenuates signals below and above the cutoff frequency.



- **Cutoff:** Adjusts the frequency below or/and above which signals will be attenuated.
- **Reso** (Resonance): With a value greater than **0**, this control will boost a small frequency range around the cutoff frequency.
- **Keytrack:** Modulates the **Cutoff** frequency value according to the played key.
- **Gain** (**Aggressive** and **Juicy** filter flavors only): Controls the amplitude increase after the filter. This control can be used to compensate for amplitude reduction due to the filter, or to increase the soft saturation of the effect.

### Amp section

The Amp section of the Sound panel contains the following controls:

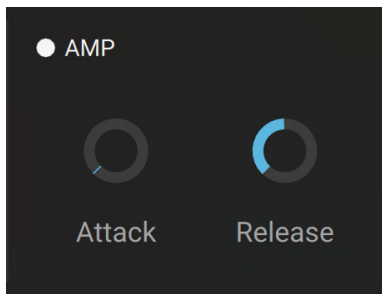

- **AMP On/Off:** Turns the processing of the sample by the Amp stage on or off.
- **Attack:** Adjusts the attack time of the sample, that is, the time it takes the sample to reach its full volume level after it has been triggered. Turning the knob to the right will result in a slower, more progressive attack phase.
- **Release:** Adjusts the release time of the sample, that is, the time it takes the sample to fade out once you have release the key. Turning the knob to the right will result in a longer fade out.

### Master section

The Master section of the Sound panel contains the following controls:

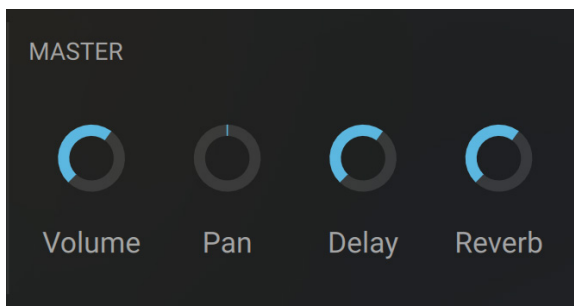

- **Volume:** Adjusts the overall volume level of the sample, from **-inf** (no sound) to **+12 dB** (maximum amplification). The default value is **0 dB** (no change in volume).
- **Pan:** Adjusts the position of the sample in the stereo field. With the knob at full left or at full right, the sample is sent only to the left channel or right channel, respectively. By default it is sent to both channels equally (knob in the center position).
- **Delay** and **Reverb:** Adjust the levels of the signal sent from this sample to the [delay and reverb send effects](#), respectively. For example, this allows you to keep particular samples from being processed by a send effect when you raise the global send level available in the [Macros](#).

### Send FX page

The Send FX page lets you configure the two send effects available in Leap.

- ▶ Click **Send FX** at the top right of the instrument to display the Send FX page.

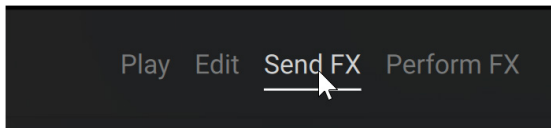

The Send FX page contains two sections:



- In the left half, the **Send A** section contains the parameters for the **Delay effect**.
- In the right half, the **Send B** section contains the parameters for the **Reverb effect**.

## Delay

The Delay effect provides the following controls:

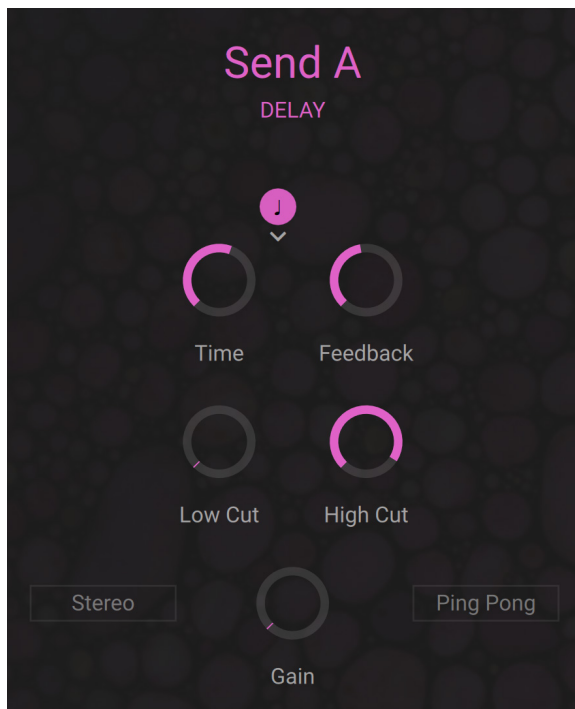

- **Sync** (note icon): When Sync is on, the delay is synchronized with the main tempo of Kontakt (which is the tempo of your DAW if Kontakt is running as a plug-in). In that case the **Time** parameter is measured in note values.
- **Note Division menu** (little down arrow): When the Sync button above is on, this selects whether the **Time** parameter should include straight, triplets, or dotted note values.
- **Time**: Adjusts the delay time. The time is measured in milliseconds (if Sync is off) or in note values (if Sync is on).
- **Feedback**: Adjusts the level of the signal that is fed back to the delay's input. Increasing Feedback adds delay repeats. Levels above 100% create swelling echo repeats up to self-oscillation.
- **Low Cut**: Cuts low-frequency content in the feedback path of the delay with a non-resonant filter. Turned fully counter-clockwise, the filter is off.
- **High Cut**: Cuts high-frequency content in the feedback path of the delay with a non-resonant filter. Turned fully clockwise, the filter is off.
- **Stereo**: When activated, the modulation between the left and the right channel is offset in time, resulting in a wide stereo effect. When deactivated, the modulation affects both channels in the same way.
- **Gain**: Adjusts the effect's return level.
- **Ping Pong**: Switches the Ping Pong effect on and off. When on, the delay repeats are panned hard left and right in an alternating pattern.

## Reverb

The Reverb effect provides the following controls:

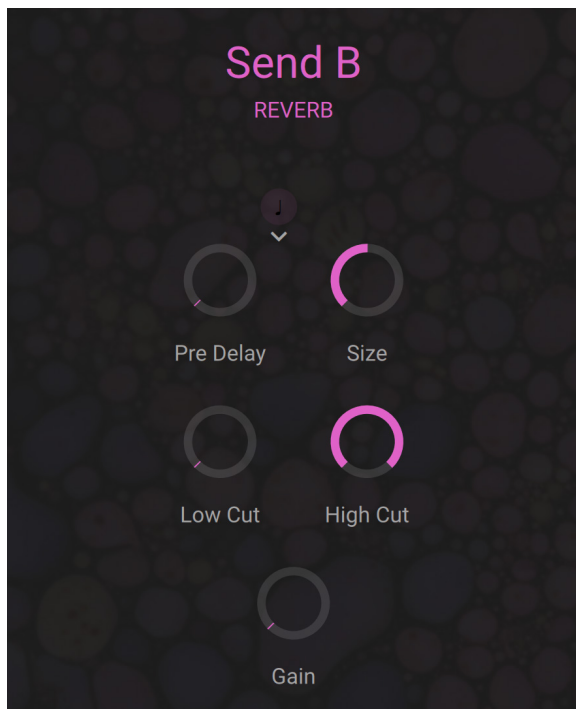

- **Sync button** (note icon): When Sync is on, the predelay of the reverb is synchronized with the main tempo of Kontakt (which is the tempo of your DAW if Kontakt is running as a plug-in). In that case the **Pre Delay** parameter is measured in note values.
- **Note Division menu** (little down arrow): When the Sync button above is on, this selects whether the **Pre Delay** parameter should include straight, triplets, or dotted note values.
- **Pre Delay**: Adjusts the duration of the predelay, which is the time it takes for the reverb effect to set in. By increasing the predelay, you can add separation between the input signal and the reverb signal. The predelay is measured in milliseconds (if Sync is off) or in note values (if Sync is on).
- **Size**: Adjusts the swell and reflection pattern of the reverb effect, creating the impression of differently sized spaces. Turning the control to the right changes the size from small to large.
- **Low Cut**: Attenuates low-frequency content of the reverb effect and the predelay's feedback signal by applying a low-shelf filter in the range of 0 to -24 dB. Turning the control to the left decreases the attenuation. Turning the control to the right increases the attenuation. Turning the control fully to the left switches the filter off.
- **High Cut**: Attenuates high-frequency content of the reverb effect and the predelay's feedback signal by applying a high-cut filter in the range of 90 kHz to 1 kHz. Turning the control to the left increases the attenuation. Turning the control to the right decreases the attenuation. Turning the control fully to the right switches the filter off.
- **Gain**: Adjusts the effect's return level.

## Perform FX page

The Perform FX page lets you configure the Perform effects available on the black keys of your keyboard when Leap is in Group mode.

**i** When Leap is in Single mode, the black keys do not trigger any Perform FX but the pitched sample instead, like the white keys. In this chapter we assume that Leap is in Group mode. For more information on the Group and Single modes, refer to [Keyboard section](#).

► Click **Perform FX** at the top right of the instrument to display the Perform FX page.

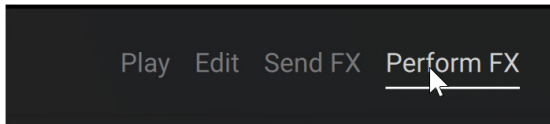

The Perform FX page shows 11 columns corresponding to the 11 black keys used for triggering Perform FX:



The columns are in the same order as the black keys in the Keyboard view below, each column controlling one particular black key:

- Black keys in a group of two (C# and D#) are assigned to either pair of Perform effects: [Double Time / Half Time](#) or [Octave Up / Octave Down](#). This assignment is fixed and cannot be changed.
- Black keys in a group of three (F#, G#, and A#) can be assigned to any of the following five Perform effects: [Gater](#), [Beat Masher](#), [Beat Slicer](#), [Reverse Grain](#), [Transpose Stretch](#). You can change these assignments to your liking.
- The rightmost single black key is always assigned to the [Double Time](#) Perform effect.

You can activate or deactivate the Perform effect for any single key by clicking the topmost icon in the column:

- ▶ Click the effect icon at the top of the desired column to activate or deactivate the Perform effect for the corresponding black key.
- When a Perform effect is deactivated, its icon is grayed out at the top of the column and in the Keyboard view below, and the effect will not be triggered when you press the key.

### Double Time and Half Time

The Double Time effect doubles the playback speed of the samples, whereas the Half Time effect halves it.



- **Effect icon:** Switches the effect on or off for the corresponding key. When the effect is off, its icon is grayed out and the effect will not be triggered when you press the key.

### Octave Up and Octave Down

The Octave Up and Octave Down effects transpose the samples one octave upward and downward, respectively.

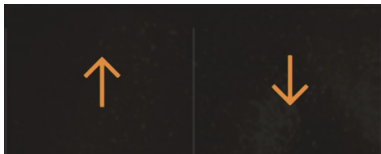

- **Effect icon:** Switches the effect on or off for the corresponding key. When the effect is off, its icon is grayed out and the effect will not be triggered when you press the key.

### Gater

Gater rhythmically mutes the incoming audio to create the classic gating effect. With the internal noise source, it can be used as a rhythmic sound generator.

Pressing and holding the black key switches the effect on until you release the key.

The effect contains the following controls:

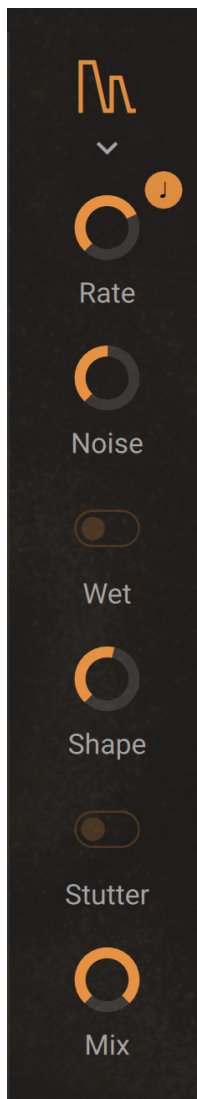

- **Effect icon:** Switches the effect on or off for the corresponding key. When the effect is off, its icon is grayed out and the effect will not be triggered when you press the key.
- **Effect menu** (down arrow): Selects a Perform effect for that key. You can choose from the following effects: [Gater](#), [Beat Masher](#), [Beat Slicer](#), [Reverse Grain](#), and [Transpose Stretch](#). If you select **None**, no effect will be assigned to the key.
- **Rate:** Adjusts the rate of the gating effect.
- **Sync** (note icon): Synchronizes **Rate** to Kontakt's main tempo. When **Sync** is on, **Rate** can be set in note values relative to the main tempo of Kontakt (which is the tempo of your DAW if Kontakt is running as a plug-in). In that case **Rate** is measured in note values and can be set to **Off**, **1/4**, **1/8**, **1/16**, and **1/32**.
- **Noise:** Adjusts the amount of hissing noise added to the signal.
- **Wet:** Mutes the input signal so that only the effect signal can be heard. When combined with the **Noise** control, the Gater can be used as a rhythmically gated noise source .

- **Shape:** Adjusts the hold and decay times of the gating effect's contour.
  - Turned fully left: 1% hold, 0% decay
  - Center position: 50% hold, 0% decay
  - Turned fully right: 0% hold, 100% decay
- **Stutter:** Sets the gating time to a 3/16 note, producing a stuttering effect.
- **Mix:** Blends between the input signal and the effect signal.

## Beat Masher

Beat Masher captures a loop from the incoming audio and manipulates it by applying rhythmic stutter, gating, repeater, and reverse effects in real time.

Pressing the black key starts the effect by recording the input signal into the internal buffer.

The effect contains the following controls:

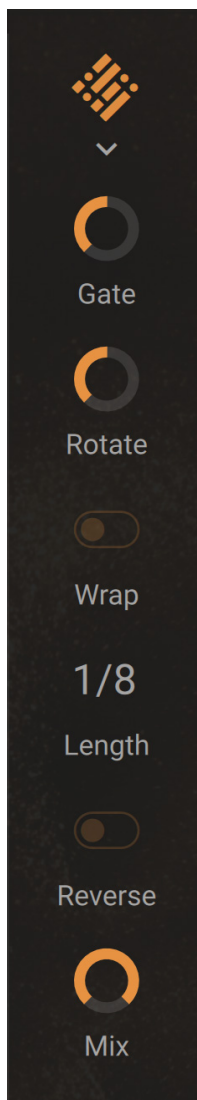

- **Effect icon:** Switches the effect on or off for the corresponding key. When the effect is off, its icon is grayed out and the effect will not be triggered when you press the key.



- **Effect menu** (down arrow): Selects a Perform effect for that key. You can choose from the following effects: **Gater**, **Beat Masher**, **Beat Slicer**, **Reverse Grain**, and **Transpose Stretch**. If you select **None**, no effect will be assigned to the key.
- **Gate**: Grabs and plays slices of audio from the internal buffer. When turned fully to the left, the effect is bypassed. When turned right towards center position, increasingly longer slices are played. When set to center position, the full buffer is played. When turned right from the center position, increasingly longer slices of audio are cut, creating a gating effect.
- **Rotate**: Shifts the audio from the buffer relative to its original position in steps of 1/8 notes.
- **Wrap**: Restarts the effect from the start of each bar independently from the **Length** setting.
- **Length**: Adjusts the length of the audio from the internal buffer, measured in note values.
- **Reverse**: Reverses the playback direction of the audio from the internal buffer.
- **Mix**: Blends between the input signal and the effect signal.

### Beat Slicer

Beat Slicer captures a loop from the incoming audio and manipulates it by rearranging slices into a variety of rhythmic patterns in real time.

Pressing the black key starts the effect by recording the input signal into the internal buffer.

The effect contains the following controls:

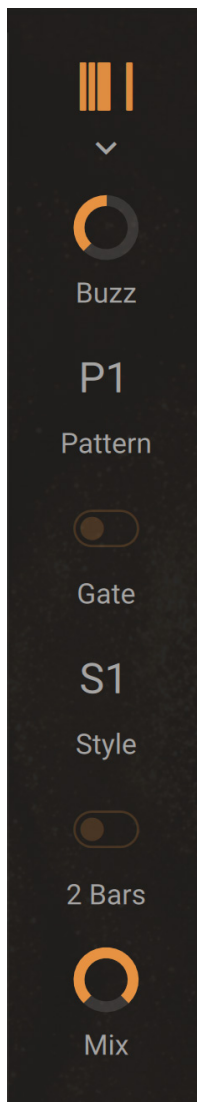

- **Effect icon:** Switches the effect on or off for the corresponding key. When the effect is off, its icon is grayed out and the effect will not be triggered when you press the key.
- **Effect menu** (down arrow): Selects a Perform effect for that key. You can choose from the following effects: [Gater](#), [Beat Masher](#), [Beat Slicer](#), [Reverse Grain](#), and [Transpose Stretch](#). If you select **None**, no effect will be assigned to the key.
- **Buzz:** Creates a rolling beat effect by repeating beats from the current pattern. Turning the control to the right increases the rate of repetition.
- **Pattern:** Selects a pattern from the group set using **Style**. The first pattern in each group plays back the unaltered audio from the buffer.
- **Gate:** Gates the audio based on a rhythm derived from another pattern, creating infinite variations through combination of the playback and gating patterns. When activated, the **Buzz** control is inactive.
- **Style:** Selects one of five groups of patterns.
- **2 Bars:** Extends the audio used from the buffer to two bars. Otherwise only the first bar of audio is used.
- **Mix:** Blends between the input signal and the effect signal.

## Reverse Grain

Reverse Grain captures a loop from the incoming audio and applies granular processing to it, including control over playback direction, pitch, and grain size.

Pressing the black key starts the effect by recording the input signal into the internal buffer.

**i** This effect needs a few seconds of audio input to work, if it stays silent, make sure to play a loop and trigger it again.

The effect contains the following controls:

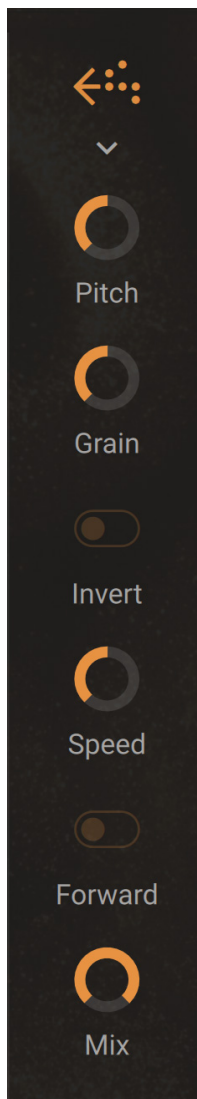

- **Effect icon:** Switches the effect on or off for the corresponding key. When the effect is off, its icon is grayed out and the effect will not be triggered when you press the key.
- **Effect menu** (down arrow): Selects a Perform effect for that key. You can choose from the following effects: [Gater](#), [Beat Masher](#), [Beat Slicer](#), [Reverse Grain](#), and [Transpose Stretch](#). If you select **None**, no effect will be assigned to the key.
- **Pitch:** Adjusts the pitch of the audio from the internal buffer. When turned fully to the right, the pitch is unaltered. Turning **Pitch** to the left pitches the audio down.

- **Grain:** Adjusts the size of the grains used to process audio from the internal buffer. Interesting effects can be achieved when combined with the **Speed** control.
- **Invert:** Plays the grains in reversed order.
- **Speed:** Adjusts the playback speed of the grains used to process audio from the internal buffer. When turned fully to the right, the playback speed is unaltered. Turning **Speed** to the left reduces the playback speed.
- **Forward:** Inverts the playback direction to forward.
- **Mix:** Blends between the input signal and the effect signal.

## Transpose Stretch

Transpose Stretch captures a loop from the incoming audio and manipulates it by means of granular pitch-shifting and time-stretching. You can use it to radically transform the sound.

Pressing the black key starts the effect by recording the input signal into the internal buffer.

The effect contains the following controls:

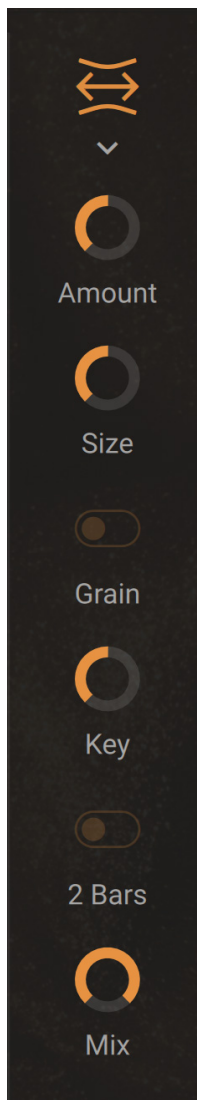

- **Effect icon:** Switches the effect on or off for the corresponding key. When the effect is off, its icon is grayed out and the effect will not be triggered when you press the key.

- **Effect menu** (down arrow): Selects a Perform effect for that key. You can choose from the following effects: [Gater](#), [Beat Masher](#), [Beat Slicer](#), [Reverse Grain](#), and [Transpose Stretch](#). If you select **None**, no effect will be assigned to the key.
- **Amount**: Adjusts the amount of time-stretching. Turning **Amount** to the right slows the audio from the internal buffer down until it freezes using a single grain.
- **Size**: Adjusts the size of the grains used to process audio from the internal buffer. When turned fully to the left, large grains of 333 ms length are produced. When turned fully to the right, small grains of 5 ms length are produced. The **Size** control only has an effect when **Grain** is activated.
- **Grain**: Activates grain size adjustment using the **Size** control. When deactivated, the grain size is automatically optimized for best pitch-shifting results
- **Key**: Adjusts the pitch of the grains used to process audio from the internal buffer in semitones. When turned fully to the left, the grains are pitched down by 60 semitones, or 5 octaves. In center position, the original pitch is maintained. When turned fully to the right, the grains are pitched up by 12 semitones, or 1 octave.
- **2 Bars**: Extends the audio used from the buffer to two bars. Otherwise only the first bar of audio is used.
- **Mix**: Blends between the input signal and the effect signal.

## Chords Tool

The Chords Tool allows you to play chords on your Kontakt Instruments by pressing a single key. The Tool provides a vast collection of chords judiciously grouped into chord sets. Each chord set includes seven chords. You can browse the available chord sets and select the desired musical characteristics to find the matching sets. When you load a chord set into the Tool, its seven chords are directly available on dedicated keys of your MIDI keyboard. You can quickly adjust various characteristics of the played chords, for example their playback behavior, the keyboard mapping, the scale, the velocities, pitches, and timings of the individual notes, etc. You can also replace single chords with ones from other sets, or record your own chords.

 For more information on saving your custom sets, refer to [Saving a User preset](#).

### Chords overview

The Chords Tool contains the following elements:

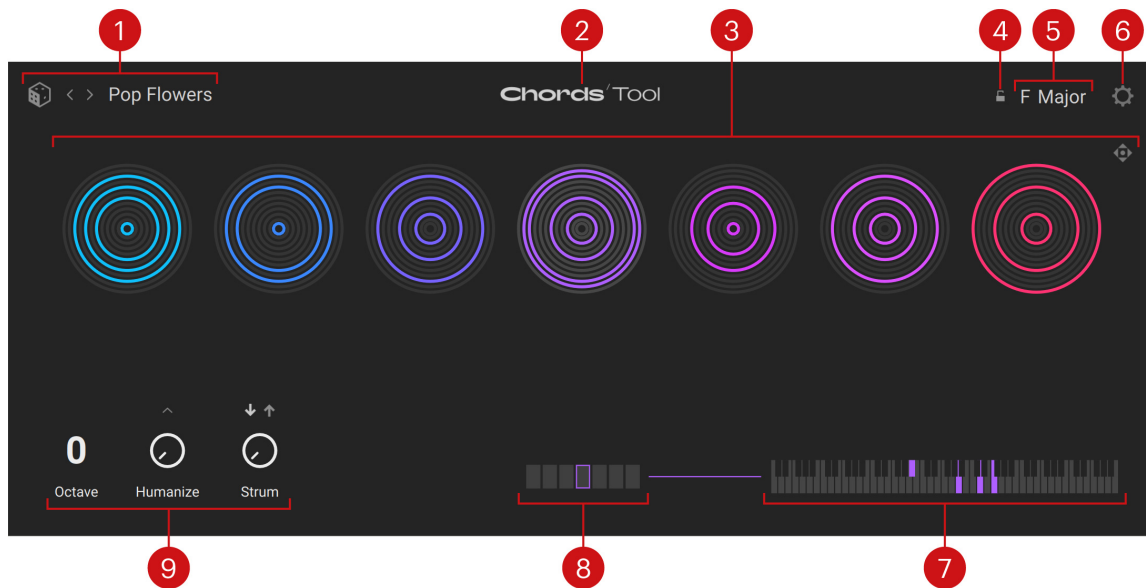

1. **Chord Set selector:** Shows the name of the loaded set of chords. You can click the name to open the [Chord Set browser](#) and select another set, or click the left/right arrows to load the previous/next set from the current result list, or click the dice to load a random set from the current result list. Each chord set contains seven chords and a particular scale. By default, when you load the chord set its chords and scale will replace the current chords and current scale.
2. **About:** Click the Tool label to open the credits.
3. **Chord Circles:** Visually represent the seven chords in the set and provides a few chord-related controls. Refer to [Chord Circles](#) for more information.
4. **Scale Lock:** Keeps the current scale when loading another chord set. This only works when loading chord sets from the Chord Set selector or the Chord Set browser, not from Kontakt's side pane nor Library Browser.
5. **Scale selector:** Shows the current scale. You can select another scale by clicking the selector and choosing a root note and a scale mode from the menu. The seven available chords will automatically adapt to match the keys in the selected scale.
6. **Settings:** Opens the [Settings page](#) page.
7. **Keybed:** Shows a little keybed on which the keys of the selected chord are lit using the chord color.
8. **Chord Slot selector:** Selects a chord slot from the current set. This is equivalent to clicking the Chord Circles except that the chord is not triggered. Upon your selection, the keybed on the right shows the keys used in that chord. Each chord slot has its own color, which is mirrored in various places to indicate the controls affecting that chord specifically.
9. **Tool Playback controls:** Adjust the global playback behavior of the Chords Tool. Refer to [Tool Playback controls](#) for more information.

## Chord Set browser

The Chord Set browser lets you replace the seven loaded chords at once with a fresh chord set from the factory library.

The Chord Set browser contains the following elements:

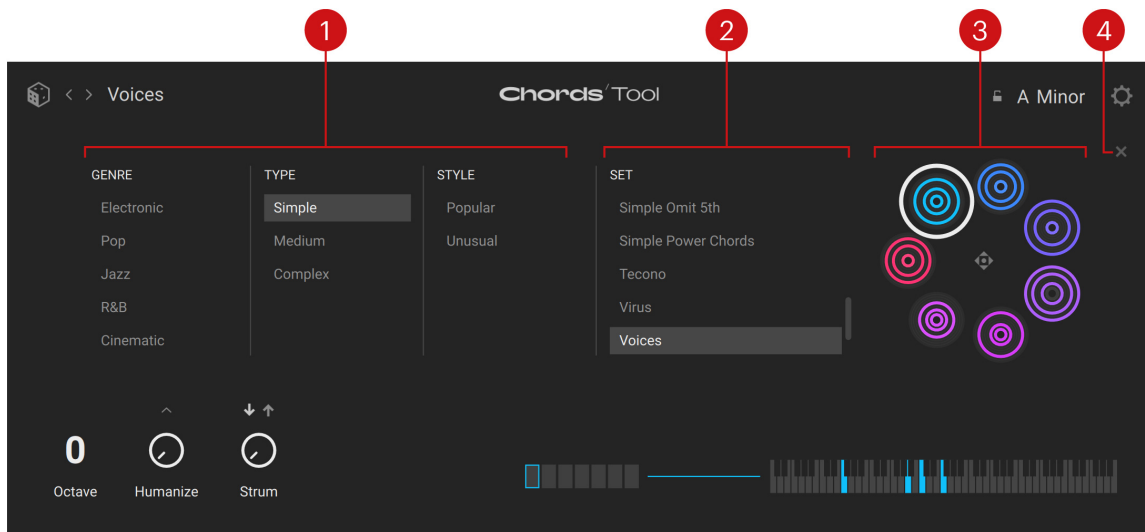

1. **Tag filter:** You can click the desired tags from the **Genre**, **Type**, and **Style** columns to select or deselect them. The **Set** list on the right is updated accordingly.
2. **Set list:** Shows the sets matching your selections in the Tag filter. You can click a set in the list to load it and replace the current set.
3. **Chord Set Preview:** Displays previews of the seven chords in the selected set. The previews are inspired by the [Chord Circles](#) displayed in the middle of the Tool interface. The preview with a white frame indicates the chord currently selected. The Chord Set Preview includes an **Export handle** in the middle: You can click it and drag it to export the entire set into your DAW.
4. **Close** (cross symbol): Closes the browser.

## Chord Circles

The Chord Circles let you quickly see and compare the shapes of the loaded chords.

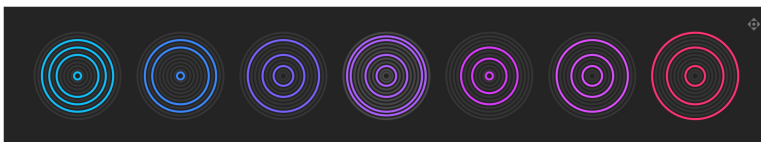

Each chord sits on a slot showing 12 concentric circles, which represent the 12 semitones of the ascending chromatic scale from C to B (C–C#–D–D#–E–F–F#–G–G#–A–A#–B), where the smallest circle in the center represents the C and the biggest circle the B. The lit circles indicate the notes used in the chord.

**i** This visualization does not distinguish between different chord positions or voicings: all the positions, inversions, and doubling of the notes in the chord will be represented by the same circles. To know the particular pitches used in the chord, take a look at the [keybed](#) in the bottom right corner.

By default, you can trigger the seven slots by pressing the white keys of the middle three octaves (C1 to C4) on your MIDI keyboard, from left to right: C–D–E–F–G–A–B. You can change this behavior by adjusting the key range triggering the chords, or by switching from Simple to Advanced keyboard mode. Both are done in the [Settings page](#).

At any time, the keys of Kontakt's on-screen keyboard and the Light Guide of the Kontrol MK3 keyboards mirror the colors of the chords that they trigger.

**i** To see the Chords' key mappings on the on-screen keyboard and on your Kontrol MK3 keyboard, make sure that the slot of the Chords Tool is selected at the top of Kontakt's side pane.

You can export the complete chord set into your DAW by clicking and dragging the **Export handle** in the top right corner and drop it onto the desired location.

When you hover over a chord slot with the mouse, additional controls appear below:

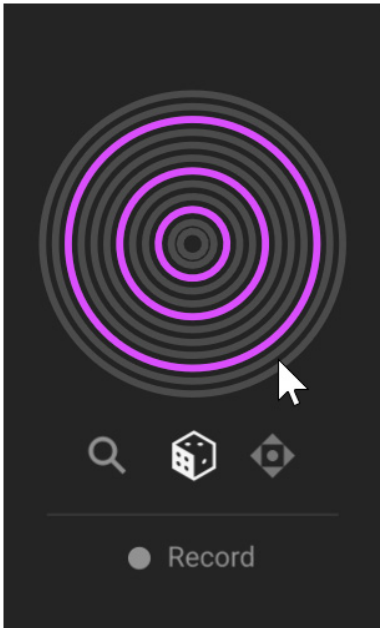

- **Magnifying glass:** Opens the [Chord browser](#), which lets you choose another chord for loading into that slot.
- **Dice:** Loads a random chord from the current result list.
- **Export handle:** Click and drag to export this single chord into your DAW.
- **Record:** Lets you create a chord manually for that slot: Click **Record**, press the desired keys on your MIDI keyboard, and click **Record** again.

## Chord browser

The Chord browser lets you replace the selected chord with a fresh one from the factory library.

The Chord browser contains the following elements:



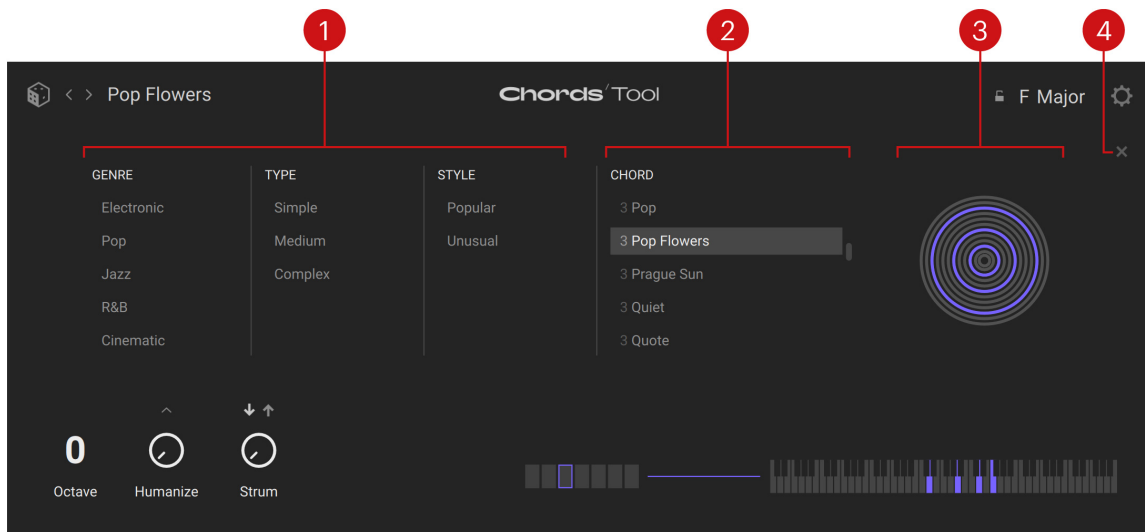

1. **Tag filter:** You can click the desired tags from the **Genre**, **Type**, and **Style** columns to select or deselect them. The **Chord** list on the right is updated accordingly.
2. **Chord list:** Shows the chords matching your selections in the Tag filter. In the list, the chords are named after the chord set they are belonging to, preceded by a number from **1** to **7** indicating their order of appearance in the set. You can click a chord in the list to load it and replace the selected chord.
3. **Chord Preview:** Displays a preview of the selected chord. The preview is inspired by the [Chord Circles](#) displayed in the middle of the Tool interface.
4. **Close** (cross symbol): Closes the browser.

## Tool Playback controls

The Tool Playback controls adjust the global playback behavior of the Chords Tool. The values for these controls are not stored in the sets. Hence, your custom settings stay valid when switching between sets.

The following controls are available:

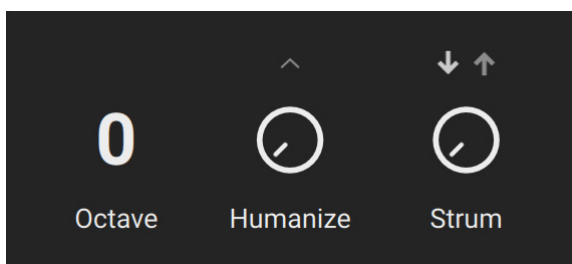

- **Octave:** Transposes all chords to a lower/higher octave.
- **Humanize:** Adds a variable amount of random imprecision when triggering the chord, which makes it sound more human. Turning the knob to the right increases the likelihood of such inaccuracies. Clicking the **little up arrow** above the knob opens the [Humanize settings](#), where you can adjust how various characteristics of the chord should be humanized.
- **Strum:** Adds a short delay between each note start, as if the chord was played by strumming the strings on a real instrument. Turning the knob to the right increases the delay between the notes. Clicking the up or down arrow above the knob will select upward or downward strumming, respectively. The Chord Circles indicate the strumming by progressively shifting the note starts clockwise from their original position at the top of the circles.

## Humanize settings

The Humanize settings let you specify different amounts of random inaccuracies for various characteristics of the triggered chords.

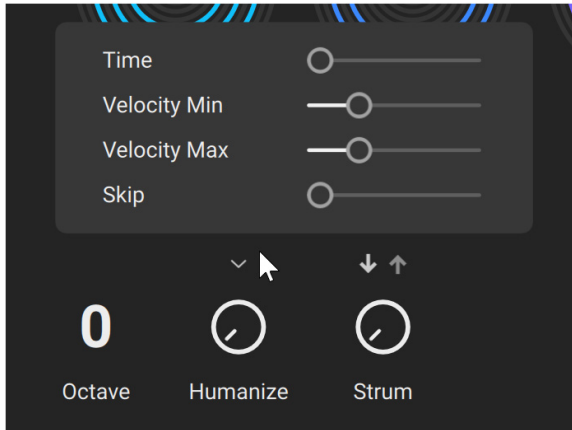

- **Time:** Inaccuracies in the timing of the notes. As you drag the slider to the right, the individual notes of the chord tend to be triggered out of time.
- **Velocity Max:** Inaccuracies in the maximum velocity of the notes. As you drag the slider to the right, the individual notes can get louder as their original velocity.
- **Velocity Min:** Inaccuracies in the minimum velocity of the notes. As you drag the slider to the right, the individual notes can get softer as their original velocity.
- **Skip:** Inaccuracies in the note trigger. As you drag the slider to the right, more notes tend not to be skipped.

**i** The influence of the Humanize features cannot be represented in the [Chord Circles](#) since they occur randomly when the notes are triggered.

## Settings page

The Settings page provides global options affecting the behavior of the Tool and its response to your actions on the keyboard.

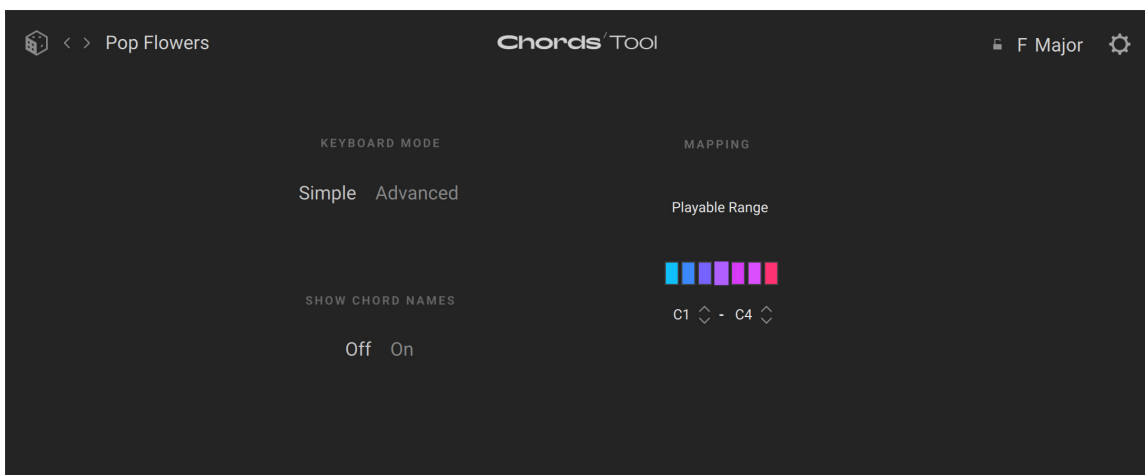

The following controls are available:

- **Keyboard Mode:** Selects between two modes for triggering the chords from your MIDI keyboard:
  - In **Simple** mode (default mode), within the range of playable keys, each white key triggers a different chord from the set according to the key degree in the C scale: For example, the C keys trigger the first chord of the set, the D keys trigger the second chord, etc. The chord pitch is set to the current root note (as specified in the [Scale selector](#)) in the octave of the pressed key. You can adjust the range of playable keys in the **Mapping** section.
  - In **Advanced** mode, distinct key ranges are used for selecting and triggering chords. A one-octave range lets you select chords (without triggering them) by pressing the white keys, using the same logic as in Simple mode: The degree of the pressed key in the C scale determines which chord will be selected. A second key range lets you trigger the selected chord at the desired pitch by pressing the corresponding black or white key. You can adjust both ranges in the **Mapping** section.
- **Mapping:** Lets you adjust the range(s) used to control your chords. The available parameters depend on the current keyboard mode:
  - In Simple mode, the **Playable Range** defines the keys that will trigger chords. Keys outside this range will be inactive. You can adjust the lower or upper end of the range by clicking the corresponding note field and dragging your mouse vertically, or by clicking the little up and down arrows next to it. Above the fields, the slots mirror the colors of the triggered chords.

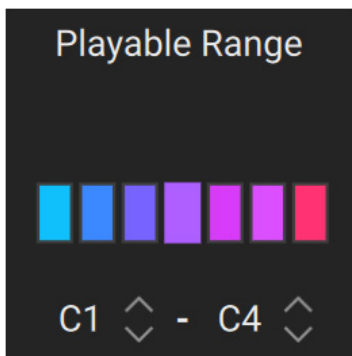

- In Advanced mode, the **Selection Range** defines the one-octave range used for selecting the chords (the range is defined by its base C key), and the **Playable Range** defines the keys used for triggering the selected chord. You can adjust either range by clicking the note fields and dragging your mouse vertically, or by clicking the little up and down arrows next to the fields.

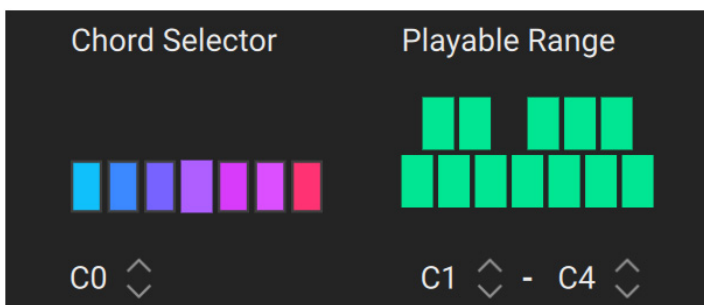

- **Show Chord Names:** When this option is on, the name of the selected chord shows up above the [Chord Slot selector](#). In addition, when you hover over the keyboard with your mouse, the name of each note in the chord appears above.

## Phrases Tool

The Phrases Tool allows you to play musical phrases on your Kontakt Instruments by pressing a single key. The Tool provides you with a vast collection of phrases judiciously grouped into phrase sets. Each phrase set includes seven phrases. You can browse the available phrase sets and select the desired musical characteristics to find the matching sets. When you load a phrase set into the Tool, its seven phrases are directly available on dedicated keys of your MIDI keyboard. You can quickly adjust various characteristics of the played phrases, for example their playback behavior, the keyboard mapping, the scale, the velocities, pitches, and timings of the individual notes, etc. You can also replace single phrases with ones from other sets to create your own custom sets.

 For more information on saving your custom sets, refer to [Saving a User preset](#).

### Phrases overview

The Phrases Tool contains the following elements:

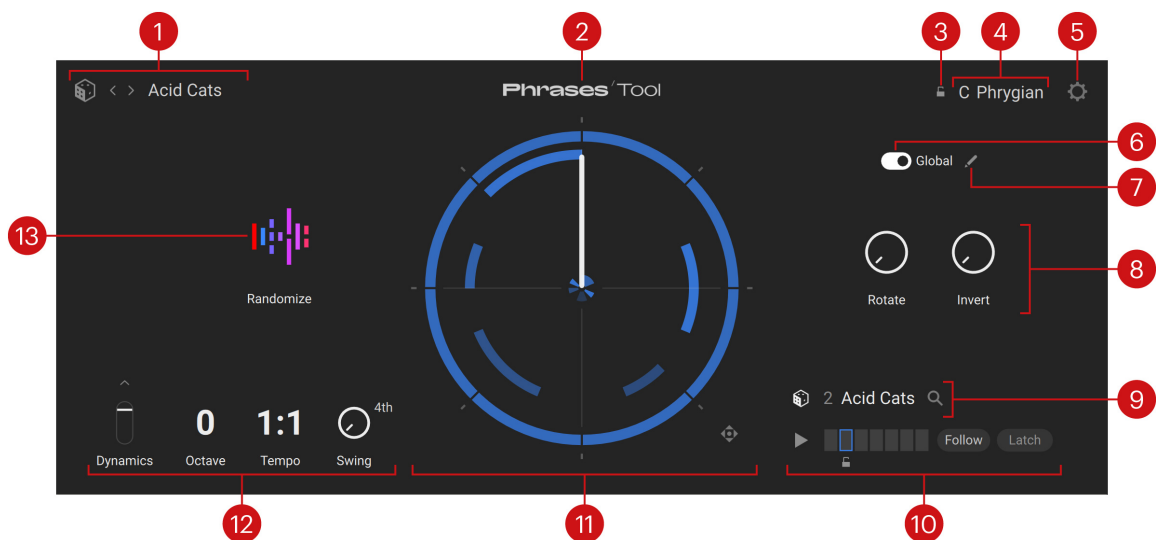

- 1. Phrase Set selector:** Shows the name of the loaded set of phrases. You can click the name to open the [Phrase Set browser](#) and select another set, or click the left/right arrows to load the previous/next set from the current result list, or click the dice to load a random set from the current result list. Each phrase set contains seven phrases and a particular scale. By default, when you load the phrase set its phrases and scale will replace the current phrases and current scale.
- 2. About:** Click the Tool name to open the credits.
- 3. Scale Lock:** Keeps the current scale when loading another phrase set. This only works when loading phrase sets using the Phrase Set selector or the Phrase Set browser, not from Kontakt's side pane nor Library Browser.
- 4. Scale selector:** Shows the current scale. You can select another scale by clicking the selector and choosing a root note and a scale mode from the menu. The seven available phrases will automatically adapt to match the keys in the selected scale.
- 5. Settings:** Opens the [Settings page](#).

6. **Global:** Defines the scope of your adjustments on certain parameters. When **Global** is on (switch to the right), the concerned parameters have no color and your edits apply globally to all the phrases in the set. When **Global** is off (switch to the left), these parameters mirror the color of the selected phrase and your edits apply only to that phrase.
7. **Edit** (pen icon): Switches to the **Phrase Edit mode**. The Phrase Edit mode lets you adjust the phrase characteristics in detail: playback, timings, pitches, and velocities.
8. **Quick Edit controls:** Shortcuts for two controls from the **Phrase Edit mode**:
  - **Rotate:** Delays the entire phrase by an adjustable amount. The circular score of the Phrase Wheel shows the delay by rotating all the notes.
  - **Invert:** Switches the pitches between the notes used in the phrase. For example, the first inversion will transpose the lowest pitch to the 2nd-lowest pitch, the 2nd-lowest to the 3rd-lowest, ... , the 2nd-highest pitch to the highest, and the highest pitch to the lowest. When turning the knob to the right from its default position at full left (no inversion), you will successively activate every inversion possible. The more pitches are used in the phrase, the more inversions will be available.
9. **Phrase selector:** Shows the name of the phrase loaded in the selected slot. Clicking the name or the magnifying glass opens the **Phrase browser**, which lets you select and load another phrase into that slot. You can also click the dice to load a random phrase from the current result list.
10. **Phrase Slot selector:** Selects a slot from the set and provides additional controls affecting the phrase selection. Refer to **Phrase Slot selector** for more information.
11. **Phrase Wheel:** Visually represents the note sequence in the selected phrase. Refer to **Phrase Wheel** for more information.
12. **Tool Playback controls:** Adjust the global playback behavior of the Phrases Tool. Refer to **Tool Playback controls** for more information.
13. **Randomize:** Set random values to most time, pitch, and velocity parameters of the phrase(s). These include the **Rotate** and **Invert** knobs in the Quick Edit controls on the right. The remaining parameters are available in the **Phrase Edit mode**.

## Phrase Set browser

The Phrase Set browser lets you replace the seven loaded phrases at once with a fresh phrase set from the factory library.

The Phrase Set browser contains the following elements:

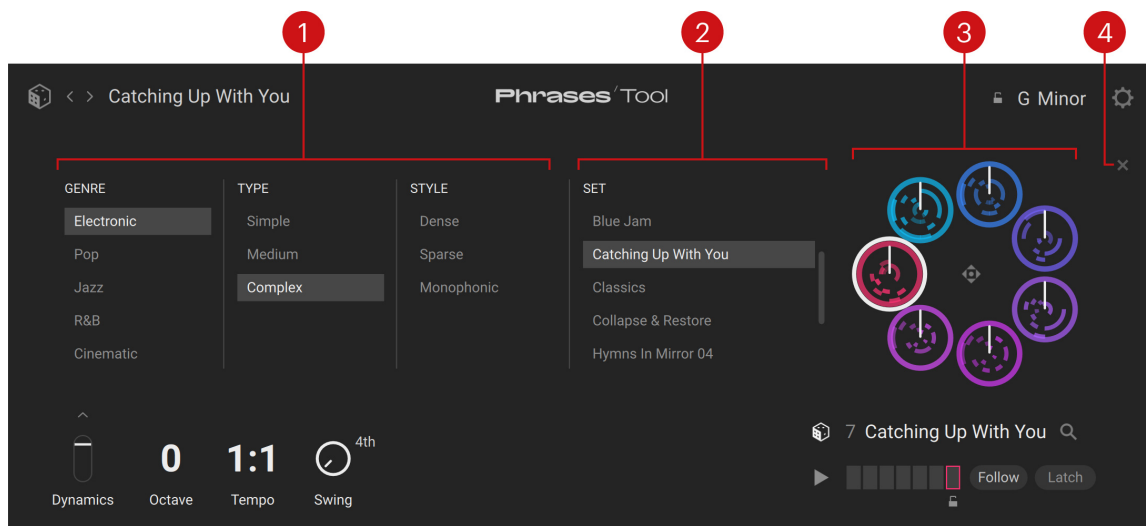

1. **Tag filter:** You can click the desired tags from the **Genre, Type,** and **Style** columns to select or deselect them. The **Set** list on the right is updated accordingly.
2. **Set list:** Shows the sets matching your selections in the Tag filter. You can click a set in the list to load it and replace the current set.
3. **Phrase Set Preview:** Displays previews of the seven phrases in the selected set. The previews are inspired by the **Phrase Wheel** displayed in the middle of the Tool interface. The preview with a white frame indicates the phrase currently selected. The Phrase Set Preview includes an **Export handle** in the middle: You can click it and drag it to export the entire set into your DAW.
4. **Close** (cross symbol): Closes the browser.

## Phrase Wheel

The phrase is shown as a sequence of notes (or pattern) on a circular score:

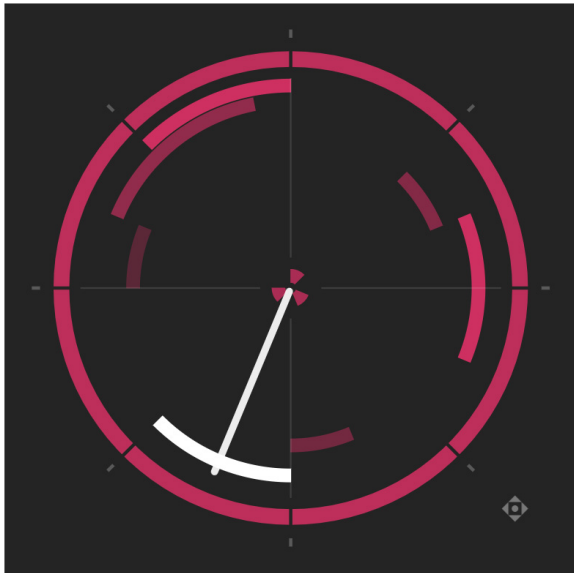

Each note appears as a curved segment with the following properties:

- Its color intensity indicates the note velocity.
- Its distance to the center indicates the note pitch.
- Its angular position indicates the note timings (note start and end).

The playback starts at the top and progresses clockwise up to one full circle, corresponding to one bar. The white hand represents the playhead: As it reaches a segment, that note is triggered and plays until the playhead reaches the segment end.

By default, a phrase plays from the beginning to the end of the sequence (one full circle). By clicking anywhere on the wheel and dragging your mouse vertically, you can adjust the end point of the phrase: In the sequence, the notes starting after the end point are grayed out and will not play. However, earlier notes that are still sounding will continue to play until their end.

The Phrase Wheel provides two additional controls:

- **Reset** (top left of the Phrase Wheel): Cancels any changes that you have made to the phrase(s) and returns to the factory version. The Reset button appears only if you have modified the phrase.
- **Export handle** (bottom right of the Phrase Wheel): Click and drag to export the phrase into your DAW.

## Phrase browser

The Phrase browser lets you replace the selected phrase with a fresh one from the factory library.

The Phrase browser contains the following elements:

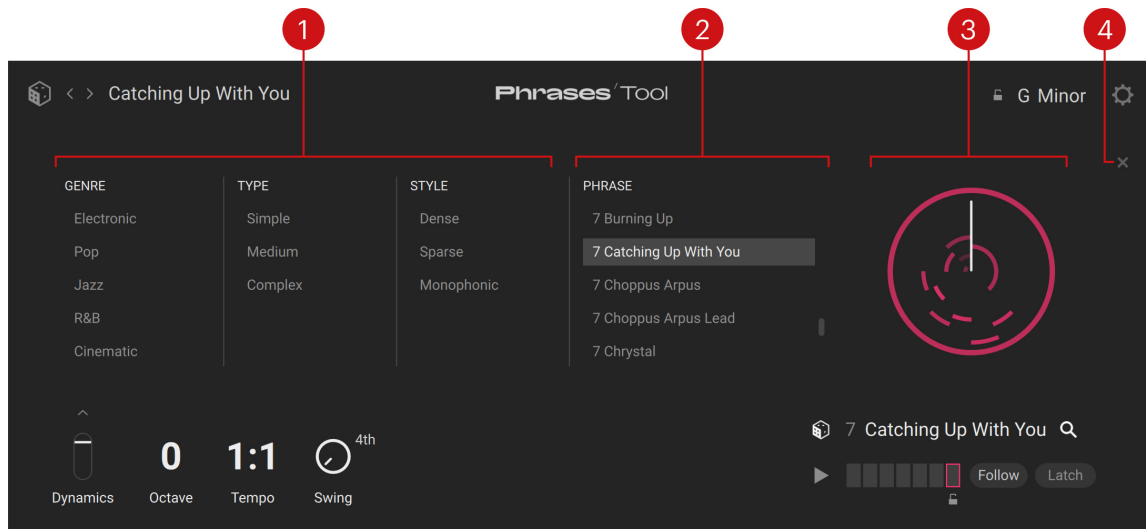

1. **Tag filter:** You can click the desired tags from the **Genre**, **Type**, and **Style** columns to select or deselect them. The **Phrase** list on the right is updated accordingly.
2. **Phrase list:** Shows the phrases matching your selections in the Tag filter. You can click a phrase in the list to load it and replace the selected phrase.
3. **Phrase Preview:** Displays a preview of the selected phrase. The preview is inspired by the [Phrase Wheel](#) displayed in the middle of the Tool interface.
4. **Close** (cross symbol): Closes the browser.

## Phrase Slot selector

The Phrase Slot selector contains the following elements:

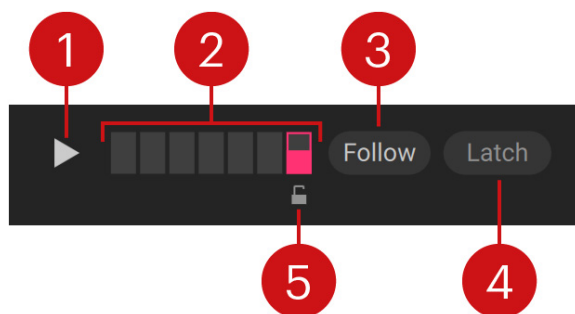

1. **Play:** Toggles the playback of the selected phrase on or off. When Play is on, selecting another slot automatically triggers its phrase.
2. **Phrase slots:** Selects a phrase from the current set. The selected slot is highlighted, its phrase is displayed in the [Phrase Wheel](#), and you can edit its settings. Each phrase slot has its own color, which is mirrored in various places of the Tool to indicate the controls affecting that phrase specifically. When the phrase is playing, a vertical progress bar runs on the slot to indicate the play position in the phrase.
3. **Follow:** If this is on, you can select phrases by pressing their key on your MIDI keyboard. If this is off, the keys trigger the phrases without selecting them.

4. **Latch**: Selects between two playback behaviors when triggering phrases via MIDI:
  - If **Latch** is off, the triggered phrase will play as long as you hold the key depressed and stop when you release the key.
  - If **Latch** is on, the phrase will go on playing until the end even if you have released the key.
5. **Lock** (below the selected slot): Keeps the current phrase in that slot when you load another phrase set. You can lock several slots in your set. You can use the lock to keep interesting phrases as you browse the available phrase sets, progressively composing your own set of phrases.

## Tool Playback controls

The Tool Playback controls adjust the global playback behavior of the Phrases Tool. The values for these controls are not stored in the sets. Hence, your custom settings stay valid when switching between sets.

The following controls are available:

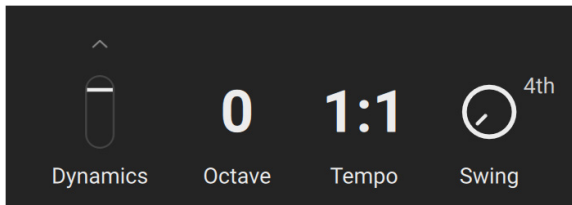

- **Dynamics**: Adjusts the overall velocity of the phrases.
- **Dynamics Source menu** (little up arrow above the **Dynamics** knob): Selects the source used to control the dynamics. You can select **Velocity** to use the velocity at which you press the keys, **Modwheel (CC1)** to use the modulation wheel on your MIDI keyboard, or **Velocity + Modwheel** to use both simultaneously.
- **Octave**: Transposes the playback by octaves up to three octaves downward or upward.
- **Tempo**: Sets the playback tempo to the double value (**2x**), the same value (**1:1**), or half the value (**1/2**) of Kontakt's main tempo. If Kontakt is running as a plug-in in your DAW, its main tempo is defined in your DAW. If Kontakt is running as a standalone application, its main tempo is defined in the [Master Editor](#).
- **Swing**: Adjusts the swing amount. The swing adds a variable delay to the notes in the second half of a chosen time division (usually the quarter note), which creates the shuffle effect commonly used in jazz music, for example.
- **Step Size menu**: Selects the time division used for the **Swing**. The default value (**4th**) corresponds to the quarter note. The available values range from **1/1** (whole note) to **16th** (sixteenth note).

## Phrase Edit mode

By activating the pen icon, you switch the Phrases Tool to **Phrase Edit mode**. In Phrase Edit mode you can modify the current phrase or the entire set more in detail. For this purpose, additional sections of parameters show up on either side of the Phrase Wheel:



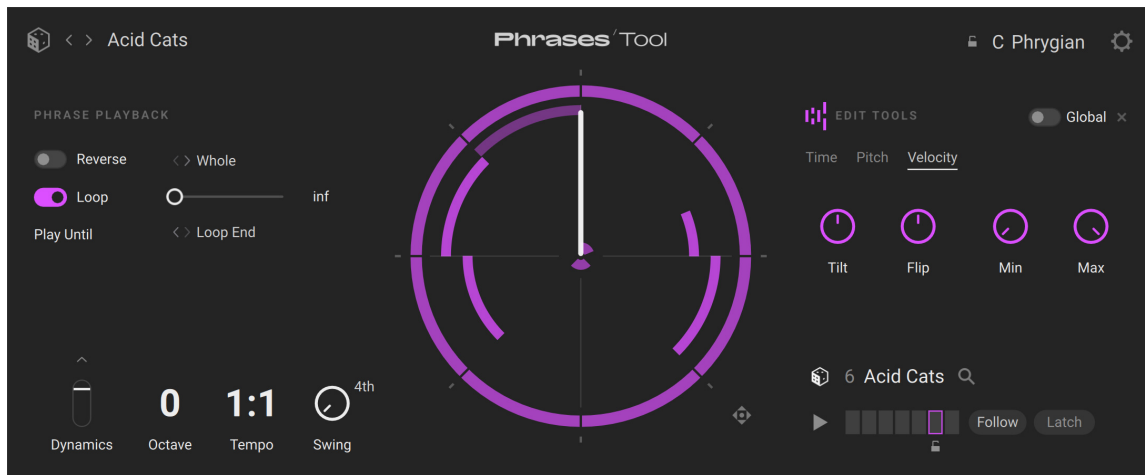

- On the left, the **Phrase Playback section** lets you configure the playback behavior of the phrase(s).
- On the right, the **Edit section** lets you adjust the timings, pitches, and velocities of the notes in the phrase(s).

### Phrase Playback section

In the Phrase Playback section you can configure the playback behavior of the selected phrase or of the entire set.

The Phrase Playback section contains the following controls:

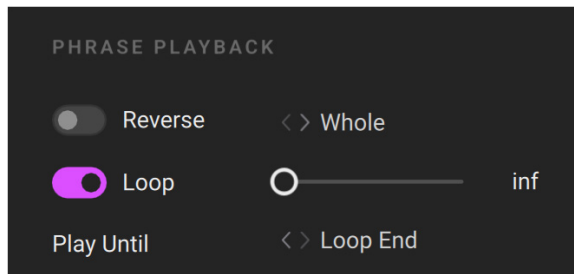

- **Reverse switch:** Turns the reverse playback on or off.
- **Reverse Range menu:** Selects the part of the phrase(s) that should play in the reverse direction, the remaining part playing forward. This control affects the playback only if the **Reverse** switch is on. The available entries are **Whole** (the whole phrase plays reverse), **First Half** (first half reverse, second half forward), **Second Half** (first half forward, second half reverse), and **Both Halves** (first half reverse, then second half reverse).
- **Loop switch:** Turns the looped playback on or off.
- **Repetitions slider:** Specifies how many times the phrase(s) should be looped. This control affects the playback only if the **Loop** switch is on. With the slider at full left (**inf**, default value), the playback is looped forever. The remaining values range from **1** to **99**.

- **Play Until menu:** Selects where the loop should end and jump back to the beginning. This control affects the playback only if the **Loop** switch is on and if the phrase's play range is shorter than a full cycle (see [Phrase Wheel](#)). Two entries are available from the menu:
  - **Pattern End:** The whole sequence (full circle) is looped, including any grayed out notes and the resulting silent part. For example, this setting is useful to preserve the loop length and keep the Tool in sync with other instruments in your DAW.
  - **Loop End:** Only the audible phrase is looped. If the phrase is shorter than a full circle, the loop will be shorter as well.

## Edit section

In the Edit section you can change the timings, pitches, and velocities of the notes in the selected phrase or in the entire set.

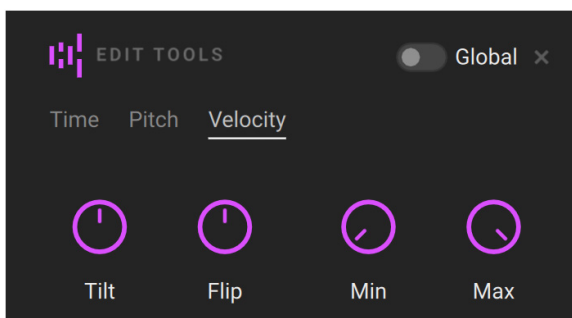

In the top row, the Edit section contains three elements, from left to right:



- **Randomize button:** Sets random values to all the continuous parameters from the Edit section. This button mirrors the bigger **Randomize** button available outside the Phrase Edit mode. If the **Global** switch on its right is on, the Randomize button shows all the phrase colors to remind you that it will affect all of them. If the **Global** switch is off, the Randomize button shows only the color of the selected phrase to indicate that it will affect only this phrase.
- **Global** switch: Specifies whether your edits will apply to the seven loaded phrases (button on) or only to the selected phrase (button off). This button mirrors the **Global** switch available outside the Phrase Edit mode.
- **Close button** (cross icon): Closes the Phrase Edit mode.



For more information on the Randomize button and the **Global** switch outside the Phrase Edit mode, refer to [Phrases overview](#).

Below, the Edit section contains three panels, which you can display by clicking the **Time**, **Pitch**, or **Velocity** tab at the top:



The **Time** panel contains the following controls:

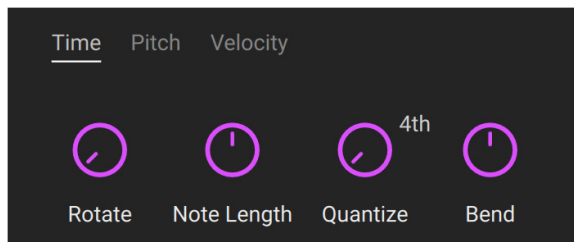

- **Rotate:** Delays the entire phrase by an adjustable amount. All the notes rotate on the [Phrase Wheel](#) as you adjust the knob. This parameter is also available in the [Quick Edit controls](#), available when the Phrase Edit mode is off.
- **Note Length:** Shortens or extends the length of all notes by moving their end points.
- **Quantize:** Adjusts the quantization applied to the notes. At full left (default setting), no quantization is applied. The more you turn the knob to the right, the closer the notes get from the time divisions selected in the Quantize Step menu.
- **Quantize Step menu:** Selects the time division to which the notes can be quantized. The available values range from **1/1** (one whole note, corresponding to one full circle) to **16th** (one sixteenth note).
- **Bend:** Bends the time line toward the beginning or the end of the sequence. From the default center position (no bending), turning **Bend** to the left will speed up the beginning of the sequence and slow down its end, whereas turning it to the right will slow down the beginning of the sequence and speed up its end. In any case, the total duration of the sequence stays untouched.

The **Pitch** panel contains the following controls:

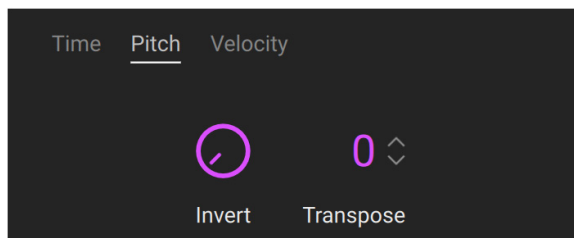

- **Invert:** Switches the pitches between the notes used in the phrase. For example, the first inversion will transpose the lowest pitch to the 2nd-lowest pitch, the 2nd-lowest to the 3rd-lowest, ... , the 2nd-highest pitch to the highest, and the highest pitch to the lowest. When turning the knob to the right from its default position at full left (no inversion), you will successively activate every inversion possible. The more pitches are used in the phrase, the more inversions will be available. This parameter is also available in the [Quick Edit controls](#), available when the Phrase Edit mode is off.
- **Transpose:** Transposes all the notes in semitones. The available values range from **-12** to **12** semitones.

The **Velocity** panel contains the following controls:

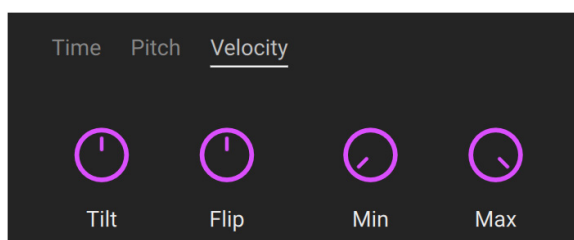

- **Tilt:** Puts the velocities on a time slope centered on the current mean of all velocities. From the default center position, turning **Tilt** to the left uses a raising slope (early notes get softer and late notes get louder), while turning **Tilt** to the right uses a decreasing slope (early notes get louder and late notes get softer). The slope becomes steeper as you move the knob further away. For example, this tool is useful to create crescendos.
- **Flip:** Modifies the gap between high and low velocities. From the default center position, turning **Flip** to the left accentuates the velocity differences between notes by amplifying the higher velocities and attenuating the lower velocities. The other way around, turning **Flip** to the right attenuates the higher velocities and amplifies the lower velocities: At first this reduces the velocity differences between notes, but turning the knob further to the right leads up to a complete velocity inversion, the soft notes being played loud and the loud notes softly.
- **Min:** Adjusts the lowest velocity available. Increasing the **Min** value shrinks the range of available velocities upward. The possible values go from **0** (default value, knob at full left, no lower velocity limit) to **100** (all the notes are set to the maximum velocity).
- **Max:** Adjusts the highest velocity available. Decreasing the **Max** value shrinks the range of available velocities downward. The possible values range from **100** (default value, knob at full right, no upper velocity limit) to **0** (knob at full left, all the notes are set to the minimum velocity).

## Settings page

The Settings page provides global options affecting the behavior of the Tool and its response to your actions on the keyboard.

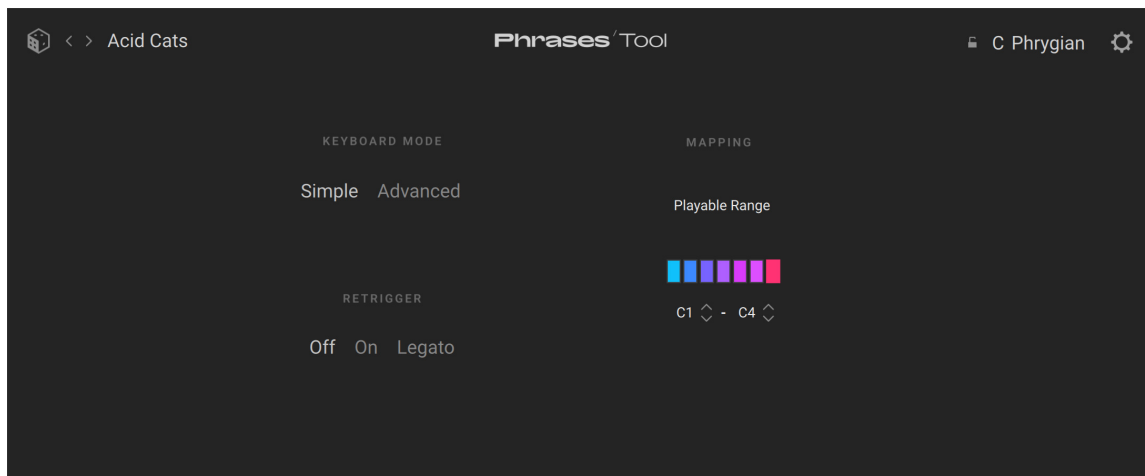

The following controls are available:

- **Keyboard Mode:** Selects between two modes for triggering the phrases from your MIDI keyboard:
  - In **Simple** mode (default mode), within the range of playable keys, each white key triggers a different phrase from the set according to the key degree in the C scale: For example, the C keys trigger the first phrase of the set, the D keys trigger the second phrase, etc. The phrase pitch is set to the current root note (as specified in the [Scale selector](#)) in the octave of the pressed key. You can adjust the range of playable keys in the **Mapping** section.
  - In **Advanced** mode, distinct key ranges are used for selecting and triggering phrases. A one-octave range lets you select phrases (without triggering them) by pressing the white keys, using the same logic as in Simple mode: The degree of the pressed key in the C scale determines which phrase will be selected. A second key range lets you trigger the selected phrase at the desired pitch by pressing the corresponding black or white key. You can adjust both ranges in the **Mapping** section.

- **Mapping:** Lets you adjust the range(s) used to control your phrases. The available parameters depend on the selected Keyboard Mode on the left:
  - In Simple mode, the **Playable Range** defines the keys that will trigger phrases. Keys outside this range will be inactive. You can adjust the lower or upper end of the range by clicking the corresponding note field and dragging your mouse vertically, or by clicking the little up and down arrows next to it. Above the fields, the slots mirror the colors of the triggered phrases.



- In Advanced mode, the **Selection Range** defines the one-octave range used for selecting the phrases (the range is defined by its base C key), and the **Playable Range** defines the range of keys that will trigger the selected phrase. You can adjust both ranges by clicking the note fields and dragging your mouse vertically, or by clicking the little up and down arrows next to the fields.

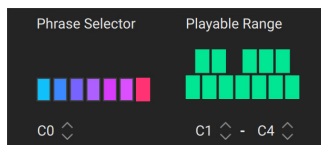

- **Retrigger:** Specifies the transition between successive phrases. If you trigger a new phrase while the previous phrase is still playing, the following behaviors are available:
  - **Off:** The new phrase seamlessly takes over from the playback position of the previous phrase.
  - **On:** The new phrase starts from the beginning.
  - **Legato:** The new phrase takes over from the playback position of the previous phrase only if you are still pressing the previous key.

## 9. Classic view

The Classic view in Kontakt is designed to discover the depth and power of its engine over time. It can be configured in a variety of ways to best suit your needs and preferred workflows. You can load instruments, combine them in multis with flexible MIDI and audio routing, and explore building your own instruments. The building blocks that make up your instruments are hierarchically organized to turn MIDI data into sound. Additionally, the Classic View offers you the infrastructure to perform a wide range of peripheral management, configuration, and monitoring tasks.

Classic view contains the following main areas and elements:

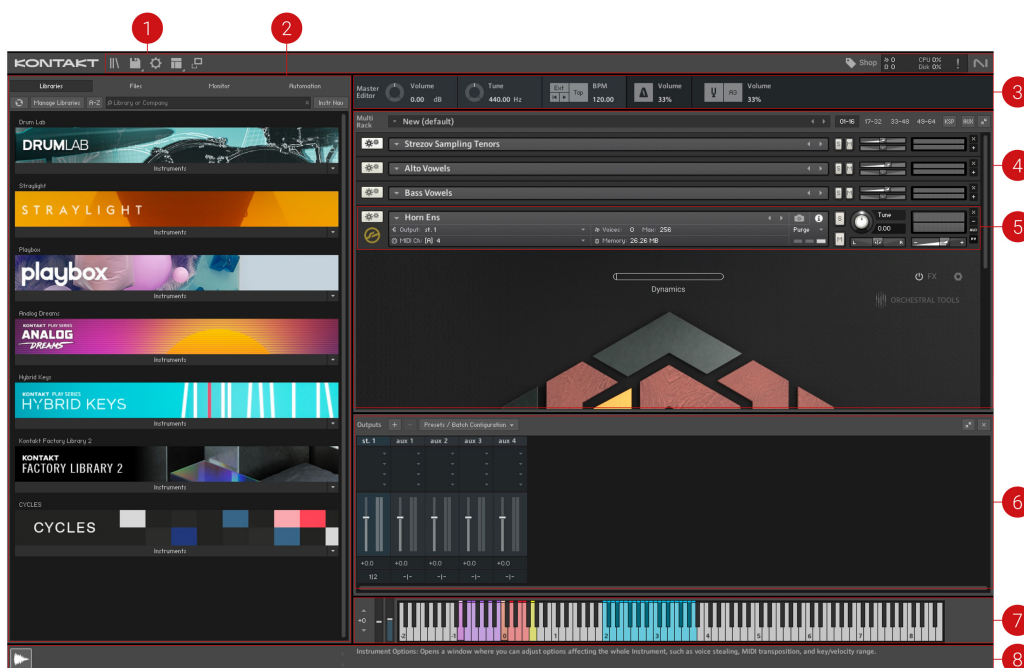

- 1. Header:** Lets you open the Library browser, show or hide elements in the user interface, and access options in the File menu. Additionally, the displays and meters keep you informed about the software status. For more information, refer to [Header](#).
- 2. Side Pane:** Provides functions for managing your collection of Kontakt-relevant files. In the screenshot, it's currently switched to the **Libraries** tab, which contains easy access to your Kontakt libraries. For more information, refer to [Side Pane \(Classic view\)](#).
- 3. Master Editor:** Contains global controls that affect the behavior of all Instruments in your Multi, as well as some common utility functions. For more information, refer to [Master Editor](#).
- 4. Rack:** Displays all Instruments in the current Multi. The Rack area is where one or more Instruments are loaded into the Multi. For more information, refer to [Instrument Rack](#).
- 5. Instrument Header** Contains the Instrument's name and various parameters, such as MIDI input channel, output level, panning position, and tuning. For more information, refer to [Instrument header](#).
- 6. Outputs Section:** Displays a channel strip for each configured Output Channel, plus four Aux Channels. For more information, refer to [Outputs Section](#).

7. **On-screen keyboard:** Displays a virtual on-screen keyboard that you can use to play instruments with your mouse, and visualize key ranges. For more information, refer to [On-screen keyboard](#).
8. **Info Pane:** Displays details of the selected Instrument file below the Side Pane, and a brief explanation of the control at the mouse position below the Rack. For more information, refer to [Info pane](#).

## Building blocks

The full functional range of Kontakt's sampling environment is split into smaller sections, which allow you to focus on specific tasks in your musical process. This functional division is also reflected on the user interface, with elements relevant to each other or a specific task kept within a distinct area, pane, tab, or dialog window.

Beginning with the smallest element and working upwards:

- A **Sample** is a simple audio file on your hard disk. Samples may occasionally carry additional metadata, but in their purest form, they don't provide anything other than a recorded audio signal. An example of a Sample would be the digital recording of a single piano note. Samples can appear in various formats, such as WAV, AIFF, or REX.
- A **Zone** is Kontakt's way of putting a Sample into a playable context. Think of a Zone as a wrapper around a single Sample; in addition to the Sample itself, the Zone contains information about which MIDI data will make Kontakt trigger this Sample, at what pitch the sample was recorded, and a few other details. An example of a Zone would be the aforementioned piano Sample, with the attached information that it should be played without any transposition whenever Kontakt receives an F3 note with a velocity value between 64 and 95. As Zones don't contain much additional data, they only exist within a larger context and can't be saved and loaded separately.
- A **Group** is a container that allows you to combine a number of Zones. As every Zone belongs to a Group (and only one), each Instrument will contain at least one Group; usually, you'll add several more Groups in order to combine your Zones by means of distinctive aspects – the aspects you choose are entirely up to you, but there are some common approaches. All Zones that belong to a specific Group will share a number of common parameters and signal flow modules; for instance, their Samples will be played by the same sound Source Module. Consequently, if you want some of your Zones played by a Source Module with different settings, you'll need to separate them into their own Group first. In the course of this manual, modules that pertain to a Group are being referred to as "Group-level modules". A typical example of a Group would be "all Zones in my Instrument that should be played at mezzoforte level". Groups can be saved and loaded separately as files with an .nkg extension.
- An **Instrument** is the entity you'll encounter most frequently when you're working with ready-made Kontakt libraries. As its name suggests, it's the virtual equivalent of an acoustic instrument – when being played, it produces a specific range of sounds, possibly at different timbres, dynamics, and articulations. Technically, a Kontakt Instrument is a wrapper for a number of Groups, whose output signals will be mixed and pass a common signal chain; the modules in this chain are said to reside on the "Instrument level". A typical example of an Instrument would be "a piano". Instruments can be saved and loaded separately; native Kontakt Instrument files have an .nki extension.

- An **Instrument Bank** is the only optional element of Kontakt's core hierarchy; in other words, you don't have to use this feature if you don't want to. Instrument Banks allow you to combine up to 128 Instruments into a container that responds to a single MIDI input channel; you can then switch the active Instrument by sending MIDI program change messages on this channel. This allows you to create General MIDI-compatible sound sets, or combine Instruments that contain various articulations of the same acoustic instrument into one slot. A typical example of an Instrument Bank would be a number of violin Instruments that contain legato, détaché, staccato, and pizzicato Samples, respectively, with the different articulations and playing techniques being switchable via program change messages. Instrument Banks can be saved and loaded separately as files with an .nkb extension.
- Finally, a **Multi** lets you freely combine up to 64 Instruments into a production setup. The Multi is the topmost element of Kontakt's core hierarchy. Each Instrument in a Multi responds to a specific MIDI channel and will send its output signal to a specific Output Channel, where the signals from all Instruments will be mixed and passed on to a physical output of your audio interface or, alternatively, to your host program. A typical example of a Multi would be "a jazz trio ensemble". Multis can be loaded and saved as files with an .nkm extension.

## Infrastructure

In addition to the individual building blocks that make up your instruments, Kontakt offers infrastructure that will simplify your everyday work:

- The **Side Pane** is located on the left side of your Kontakt window and can optionally be hidden to save screen space; it provides a convenient way to organize and access all Kontakt-relevant files on your system, such as Instruments, Multis, or Banks. The Side pane also offers a number of additional utility functions. For more information, refer to [Side Pane \(Classic view\)](#).
- The **Rack** occupies the largest amount of space in your Kontakt window; it operates in one of two different modes. In Multi Instrument mode, the Rack will provide an overview of all Instruments that are currently in your Multi, along with some general parameters. Clicking on the wrench icon on the left side of an Instrument Header will switch the Rack into Instrument Edit mode, which provides a flexible and adjustable view of the contained module panels, editors, and modulation tables of this Instrument. For more information, refer to [Instrument Rack](#).
- The **Outputs section** is a mixer-style environment in which you can adjust output levels, assign Output Channels to physical outputs, and use signal processing modules that operate on the output signals of all Instruments in your Multi. For more information, refer to [Outputs Section](#).
- The **virtual on-screen keyboard**, the **Master Editor**, the **Info Pane** and the **Options dialog** provide various utility functions and are being explained in detail within their respective sections of this manual. For more information, refer to [Header](#).
- The **Library Browser** provides access to all your your Kontakt Factory Libraries, Instruments, Snapshots and Multis, as well as your custom User content and presets. For more information, refer to [Browser and presets](#).

## Instrument Rack

The Rack is where you will spend most of the time when working with Kontakt. It operates in one of two modes: the Multi Instrument mode allows you view and edit your Multi and the Performance views of the Instruments in it, while the Instrument Edit mode lets you edit the inner workings of a single Instrument.



In Multi Instrument mode, any Instrument in the Multi will be shown as a horizontal Instrument Header, which contains the Instrument name and related settings. Your Multi can contain up to 64 Instruments, which will be spread across 4 pages of up to 16 Instruments each.

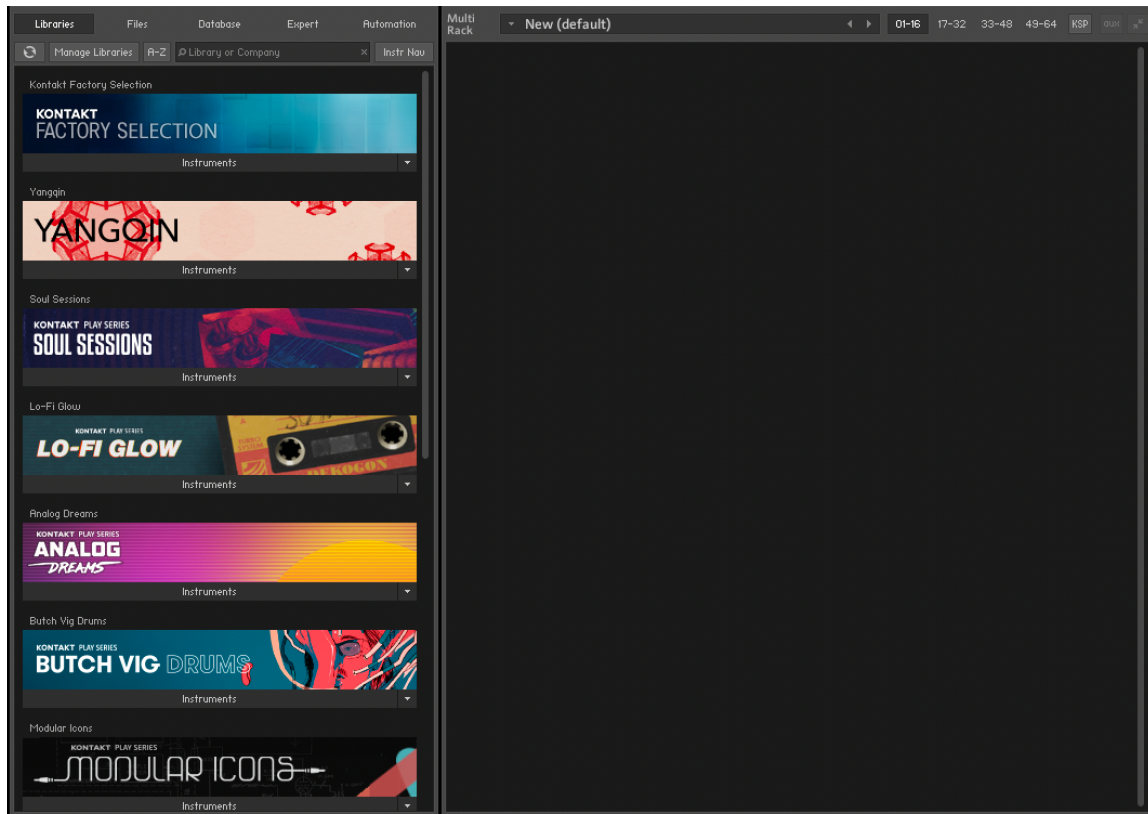

## Rack header

At the top of the Rack section is the Rack header, which is always visible as long as the Rack is in Multi Instrument mode. Use the header to switch between the four Multi pages, show or hide Aux send controls, and resize all Instrument Headers.

The Rack header contains the following features and controls:



1. **Multi Name:** A text field contains the name of your currently loaded Multi; if you have just started Kontakt, this will read **New (default)**, as this is the default Multi file that will be loaded on startup. To change the name, click the text field and enter a new one.
2. **Multi Browse** (<> icons): The left and right arrow buttons will replace your Multi with the previous or next one from the same directory, if there are any.
3. **Pages:** Four page buttons allow you to switch between the four Instrument pages. Each Multi can contain up to 64 Instruments, arranged across four pages of 16 Instruments each. You can use these pages to keep your Instruments in separate categories when your Multi is very large, or you can just switch to the next page when the 16 available Instrument slots of your current one are occupied.

4. **Multi Workspace Buttons:** These three buttons alter the workspace in some way, displaying or hiding certain controls, or minimizing all Instruments at once.
- **KSP:** Toggles the visibility of a global Script Editor pane, where you can create, edit and manage Multi Scripts that operate on a higher level than normal Instrument Scripts.
  - **Aux:** Toggles the display of Aux send controls that enable you to adjust the signal level at which each Instrument is routed to the Aux Channels. For more information, refer to [Working with Aux Channels](#).
  - **Minimize/Maximize all Instrument Headers:** Toggles all Instrument Headers in your multi between their minimized and maximized size. At their normal size, Instrument Headers contain more information, but also occupy more screen space. Use this feature to see an overview of all Instruments on a page or to save screen space when you're not planning to adjust any Instrument parameters. For more information, refer to [Instrument header \(minimized\)](#)

**i** Another option is to assign all Instruments on a page to channels of the same MIDI port; if you have four ports at your disposal, this method lets you easily keep track of your MIDI assignments in large Multis. However, assigning several Instruments to the same MIDI channel is a quick way of creating layered sounds.

## Instrument header

Whenever you open a new Instrument, it will appear in the Rack as an Instrument Header. Each Instrument Header can be optionally reduced in size. At regular size, as shown below, the header displays parameters that describe how the Instrument will work in the context of the current Multi. It also provides some controls to adjust parameters like the Instrument's output volume, panning position, and solo/mute status.

The Instrument Header contains the following settings and controls:

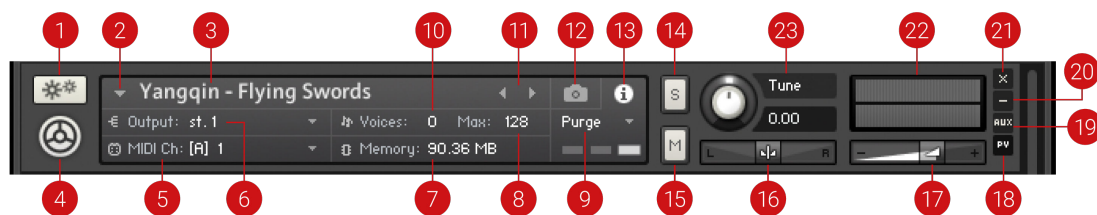

1. **Instrument Options** (cog icon): Opens the Instrument Options dialog, where you can access features that affect the whole instrument such as voice stealing, MIDI transposition, and key/velocity range.
2. **Quick-Load Menu:** Opens a dropdown menu that gives access to your Quick-Load Browser.
3. **Instrument Name:** Displays the Instrument's name. Edit the name by clicking on it and entering a new one. The name displayed here will be identical to the file name (without the .nki extension) when you load and save the Instrument.
4. **Instrument Icon:** Kontakt Instrument creators can choose from a range of icons that indicate the general category of their creation. Some libraries will also use custom icons. Clicking this icon will toggle the Instrument's Performance View on or off, if available.

5. **MIDI Channel:** Indicates the currently assigned MIDI input channel that the Instrument will respond to. Clicking it will open a drop-down menu that allows you to select a new MIDI channel for this Instrument. The **Omni** setting will make it respond to MIDI data on any channel; below it, the available ports of your MIDI interface will appear as sub-menus, each one containing the 16 channels of the respective ports. Note that the maximum number of distinct MIDI channels that you can use is 64 in the stand-alone version of Kontakt, and 16 when using Kontakt as a plug-in.
6. **Output Channel:** Displays the currently selected Output Channel that will receive the output signal from this Instrument. Clicking on the channel name will open a drop-down menu with all currently defined Output Channels, where you can assign the Instrument to a different channel.
7. **Memory:** Indicates how much system memory is currently being used by the Sample data of this Instrument.
8. **Max Voices:** Defines the maximum number of voices that the Instrument may use at any time. Change this value by clicking on it, then dragging the mouse up or down. If you notice that the number of currently used voices rises to the Max Voices value during play and you hear that voices are being cut off, try increasing this value.
9. **Purge:** This button opens a drop-down menu that lets you execute the functions related to Kontakt's purge mechanism on a per-instrument basis. The purge facility is explained in section [Purge menu](#).
10. **Voices:** This number indicates how many voices are currently being used by the Instrument.
11. **Previous / Next buttons:** The left/right arrow buttons exchange the Instrument with the previous or next one from the same directory, respectively.
12. **Snapshot View:** Provides access to Snapshot features including loading, saving and deleting Snapshots. For more information, refer to [Using Snapshots](#).
13. **Info View:** Provides access to the Instrument's Audio and MIDI configuration, as well as Voices and Memory consumption.
14. **Solo button:** When activated, all other Instruments in the Multi are muted, and the output signal can be heard in isolation. How Kontakt will handle multiple Solo selections is determined by the Solo Mode setting, refer to [Handling](#).
15. **Mute button:** When activated, the current Instrument is muted, thus temporarily removing its output signal from the Output Channel.
16. **Pan:** Adjusts the panorama position of the Instrument's output signal.
17. **Volume:** Adjusts the output volume of this Instrument. Select whether the default value of Volume sliders will be -6 dB or 0 dB in the **Options** dialog.
18. **PV:** Toggles the Performance View panel on and off, if PV is available in the instrument. For more information, refer to [Performance view](#).
19. **Aux:** Shows and hides the row of Aux send sliders below this Instrument Header.
20. **Minimize View:** Minimizes the Instrument Header. This allows you to adjust the display sizes of headers individually.
21. **Remove Instrument:** Removes the respective Instrument from the Multi.
22. **Level Meters:** LED-style bar graph meters indicate the current output levels across all channels of this Instrument.
23. **Tune:** Adjusts the pitch of the Instrument. Turning the knob left or right will increase or decrease the pitch, respectively. The control covers a range of +/- 3 octaves and moves in semitone increments. Hold [Shift] while adjusting the control for fine tuning.

## Purge menu

The purge mechanism in Kontakt keeps track of which Samples in an Instrument have been actually triggered since the Instrument was loaded, and gives you the option of removing all other Samples from the Instrument. This way, you can reduce the number of Samples that are being kept in memory to the subset that you have actually used in your arrangement.

Using the purge facility, you can play your part once – this will allow Kontakt to gather which Samples are actually being used – and then eliminate all unused Samples from the memory. The Instrument will work as it did before, but notes or velocity ranges that didn't occur during the analyzing phase won't play anymore. If you change your mind later, you can reload all Samples with one mouse click.

**i** Using purge functions like this can cause problems with instruments that randomly trigger samples, or use round robin options. Check the library specification before you use these options.

A purge menu is available for each Instrument; this allows you to use the purge feature on Instruments whose parts are already finished, while keeping others that are still in active use loaded in their entirety. You can access the local purge menu of an Instrument at the right side of the Instrument Header.

The Purge menu contains the following functions:



- **reset markers:** Deletes all flags, thereby resetting all data that Kontakt has gathered about Sample usage so far. Whenever Kontakt plays a Zone in your Instrument, it will flag the respective Sample as being used. After you have finished working on a part, you should select this function once and then play your part; this way, only the notes that have actually made it into the final part will be flagged as used. Afterwards, you can proceed by choosing the **update sample pool** function described below.
- **update sample pool:** Removes all Samples that are not currently flagged as being used from memory, and reloads any currently purged Samples that have been triggered since the last purge operation. In other words, it brings the sample pool in sync with the Sample usage flags it has gathered since the last purge operation.
- **purge all samples:** Unloads all Samples from RAM. This allows you to reverse the usual purge process: you can play your arrangement in a "silent run", and then load only the Samples that are actually being used via the **Update Sample Pool** command afterwards.
- **reload all samples:** Reloads all Samples, reverting any previous purge actions.

## Instrument header (minimized)

If you want to save screen space, you can switch all (or a selection of individual) Instrument Headers to a minimized view, which contains only the most important parameters and controls.

In this mode, the Instrument Header includes only the Instrument Options button, the Instrument Name field, Solo and Mute buttons, Output Volume, Pan sliders, Level Meters, and buttons for removing this Instrument from your Multi and switching the header back to its normal size. For more information on the related controls, refer to [Instrument header](#).

To minimize all Instrument Headers:

- ▶ Click the Minimize All Instrument Headers button, on the right side of Rack header.

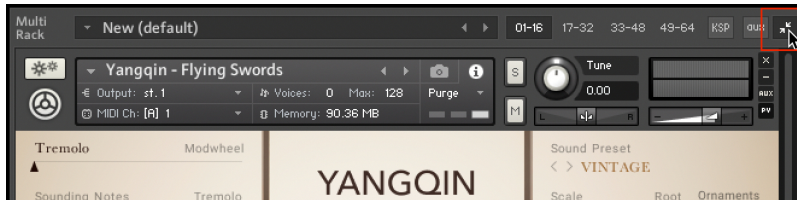

→ All Instrument Headers in the Multi Rack are minimized.



To minimize individual Instrument Headers:

- ▶ Click the Minimize Instrument Header button, on the right side of the Instrument Header.

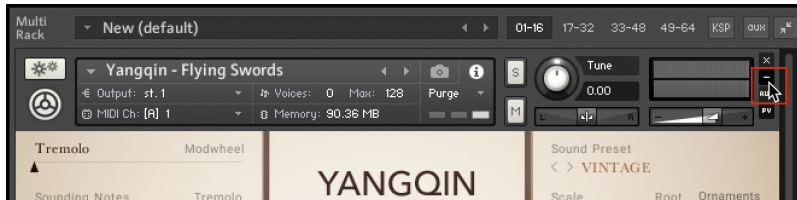

→ The selected Instrument Header in the Multi Rack is minimized.

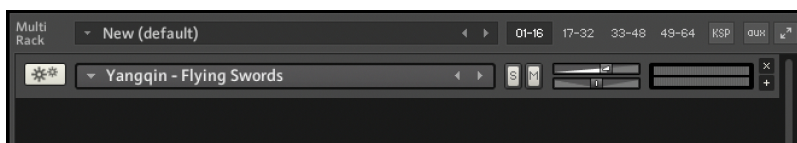

## Performance view

Using Kontakt's internal scripting language, an Instrument can provide a custom control panel called a Performance View. This feature provides Instrument-specific settings in a user-friendly way that doesn't require access to Instrument Edit mode.

All Instruments included in the Kontakt library provide Performance Views, with various styles, controls, and features. Some Instruments include performance controls, sound editing parameters, marcos, and settings relating to Kontakt's operation and playback.

In Performance View, an Instrument's custom panel will appear below the Instrument Header in the Rack.





**i** Note that Performance Views appear only below Instrument Headers at normal size, not below minimized headers. Also, you can turn control panels of Scripts in your Instrument into Performance Views yourself. For more information, refer to [Editing and Saving a Script](#).

## Instrument Edit Mode

Whenever you edit an Instrument, the Rack will switch into Instrument Edit mode. In this mode, all other Instrument Headers will no longer be visible. You can still access them via the Instrument Navigator pane of the Side pane, refer to [Instrument Navigator Pane](#). Instead, the whole Rack space will be dedicated to the editors, control panels, and modulation tables of your selected Instrument.

When in Instrument Edit mode, the Rack header allows you to manage your Groups, Undo or Redo your most recent actions, save the Instrument, or switch the edit view to the previous or next Instrument in your Multi.

To edit an Instrument:

- Click the wrench icon of its Instrument Header when the Rack is in Multi Instrument mode.

### The Rack Header

When switching to Instrument Edit mode, the header at the top of the Rack pane will change. In Instrument Edit mode, the Rack header contains the following controls:

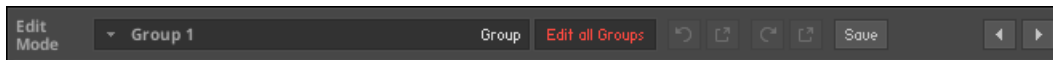

- **Exit button:** Reduces the Instrument and returns to the Multi Instrument view.
- **Displayed Group:** Indicates the name of the Group whose parameters are currently being displayed by the Group level modules. When you click it, a drop-down menu that contains all Groups in your Instrument will appear. Choosing one of these Groups will select it for display and editing.
- **Edited Groups:** Indicates whether parameter adjustments on the Group level will affect just one or multiple Groups. If it reads **Group**, any parameter changes will only affect the current Group; **Multi** indicates that multiple Groups are currently selected for editing, and **All** warns you that all Groups of your Instrument are currently selected for editing.
- **Edit All Groups button:** Toggles the selection of all Groups for editing, with the same function as the **Edit All Groups** button in the upper left corner of the Group Editor.
- **Undo button:** When you click the circled arrow of this button, your last action will be undone. As Kontakt keeps a log of your actions, you can revert more than one action to return to a specific point in your editing history. Clicking on the small down arrow icon at the right of this button will open your edit history in a dialog window; selecting an action will take you back to this point in your edit history. Note that the **Undo** and **Redo** facilities are only available when you're working in Instrument Edit mode. To enable the Undo function, open the **Handling** tab in Global Options and select the **Enableundo** option.
- **Redo button:** If you reverted one or more actions via the **Undo** button and change your mind, you can restore parts of your changes by clicking on the circled arrow of the **Redo** button. Note that you have to do this right after using the **Undo** function; if you perform any other actions after using **Undo**, your edit history cannot be restored. Just like the **Undo** button, the **Redo** button will open a history list dialog when you click the small down arrow at its right side.
- **Quick-Save:** Saves your Instrument in its current state; if you haven't saved it before, a **Save** dialog will appear, otherwise Kontakt will overwrite the last version right away. Use this button generously when you're in the middle of complex editing tasks; this way, you can always revert to the last saved version if something goes wrong.
- **Previous / Next Instrument buttons:** Switches the Instrument Edit view to the previous or next Instrument in your Multi.

## Instrument Edit Mode

Below its own header, the Rack displays the Instrument Header of your edited Instrument (this is identical to the one that's being displayed in Multi Instrument mode), a row of buttons that will show and hide editors for various aspects of your Instrument, and a flexible vertical view in which you can access all editors, modulation and routing tables, control panels, and signal processing chains of your Instrument. The four sections at the bottom of the Rack — labeled **Buses**, **Insert Effects**, **Send Effects**, and **Modulation** — can be optionally hidden from view by clicking the button next to their titles. When you choose to show all details, the Instrument Edit view of a full-sized, complex Instrument might look similar to this:



This is the Instrument Edit rack, with all editors and panels open; you don't have to know every panel inside out before you can create useful Instruments or edit existing ones. Conquer the interface one step at a time and refer to this manual and the Info Pane whenever you are unsure of a specific knob, button or menu function

The Instrument Edit rack contains the following panels and features:

- **Instrument Header:** This is the same header that is displayed when the Rack is in Multi Instrument mode. You can switch back to the Multi Instrument mode by clicking on the wrench icon. For more information, refer to [Instrument header](#)
- **Editor Buttons:** These buttons toggle the display of various editor panels in the Instrument Edit view. The Mapping Editor and Wave Editor buttons have an arrow icon on their right sides; clicking on this when you're running Kontakt in stand-alone mode will open the respective editor in a separate window. The leftmost button, labeled **Instrument Options**, is special and will be explained below.



- **Script Editor** (visible if the **Script Editor** button is activated): In this editor, you can load Scripts, access their user interfaces, and edit their source code. For more information, refer to [Script Editor](#).
- **Group Editor** (visible if the **Group Editor** button is activated): This is where you select, edit, and manage the Groups in your Instrument. For more information, refer to [Group Editor](#).
- **Mapping Editor** (visible if the **MappingEditor** button is activated): This editor lets you add Samples to your Instrument, map them to the keyboard, assign them to velocity ranges, and manage the Zones in your Instrument. For more information, refer to [Mapping Editor](#).
- **Wave Editor** (visible if the **WaveEditor** button is activated): This is where you work on the Sample level to create loops, define Slice markers for rhythmic Samples, create Zone Envelopes, and perform destructive audio editing operations. For more information, refer to [Wave Editor](#).
- **Source Module**: This core module takes care of the Sample playback mode for the Group. For more information, refer to [Source Module](#).
- **Source Modulation Router**: In this table, you can define modulation assignments, which change parameters of the source module over time in a variety of different ways.
- **Group InsertEffects**: This chain consists of 8 slots, each of which can take up a signal processing module. Each Group has its own Insert Effects chain, which will operate polyphonically (i.e. on the signal of each voice that originates in this Group separately). For more information, refer to [Group insert effects](#).
- **Signal Processor Controls** (visible if the Edit button on the chain module above is activated): This panel contains the controls of a signal processing module in the Group Insert Effects chain. For more information, refer to [Group insert effects](#).
- **Amplifier Module**: This module will shape the volume, pan, and phase of the source signals in each Group. For more information, refer to [Amplifier Module](#).
- **Modulation Router** (visible if the **ChannelRouting** button on the Amplifier panel is activated): This matrix allows you to configure the signal handover between the Group and Instrument signal flow level.
- **Instrument Bus Effects Chain**: In this area you can apply different effect chains to up to 16 different buses. Buses can be used to apply effect chains to different collections of Groups. In the same way a Group processes a collection of Zones, a Bus will process a collection of Groups (however Bus level effects are not polyphonic and cannot have modulation assignments like Group level effects). For more information, refer to [Bus insert effects](#).
- **Signal Processor Controls** (visible if the Edit button on the chain module above is activated): This panel contains the controls of a signal processing module in the Instrument Bus Effects chain.
- **Instrument Insert Effects chain**: This chain could be considered the master effects of the instrument, affecting all signals that pass through the instrument's main output. For more information, refer to [Instrument insert effects](#).
- **Signal Processor Controls** (visible if the Edit button on the chain module above is activated): This panel contains the controls of a signal processing module in the Instrument Insert Effects chain.
- **Send Effects Slots**: These slots take up signal processing modules which act as send effects; they can be fed individually with signals from various points of the signal flow. They are routed in parallel to each other and to the Insert Effects chain. For more information, refer to [Instrument send effects](#).
- **Signal Processor Controls** (visible if the Edit button on the Send Effects slots module above is activated): This panel contains the controls of a signal processing module in one of the Send Effects slots.

- **Modulation Sources:** This section contains a panel for each modulation source that you have defined in the displayed Group. For more information, refer to [Modulation source reference](#).

## Instrument Options Dialog

When you click on the leftmost button below the Instrument Header while editing an Instrument, the **Instrument Options** dialog will appear. It allows you to adjust parameters that affect this Instrument's playback behavior, MIDI response, and appearance in the Rack. The **Instrument Options** are divided into four categories; you can access these by clicking on the respective tabs on the left side of the dialog window.

### Instrument Tab

The Instrument tab of the Instrument Options dialog contains general options that affect the playing behavior of the respective Instrument.

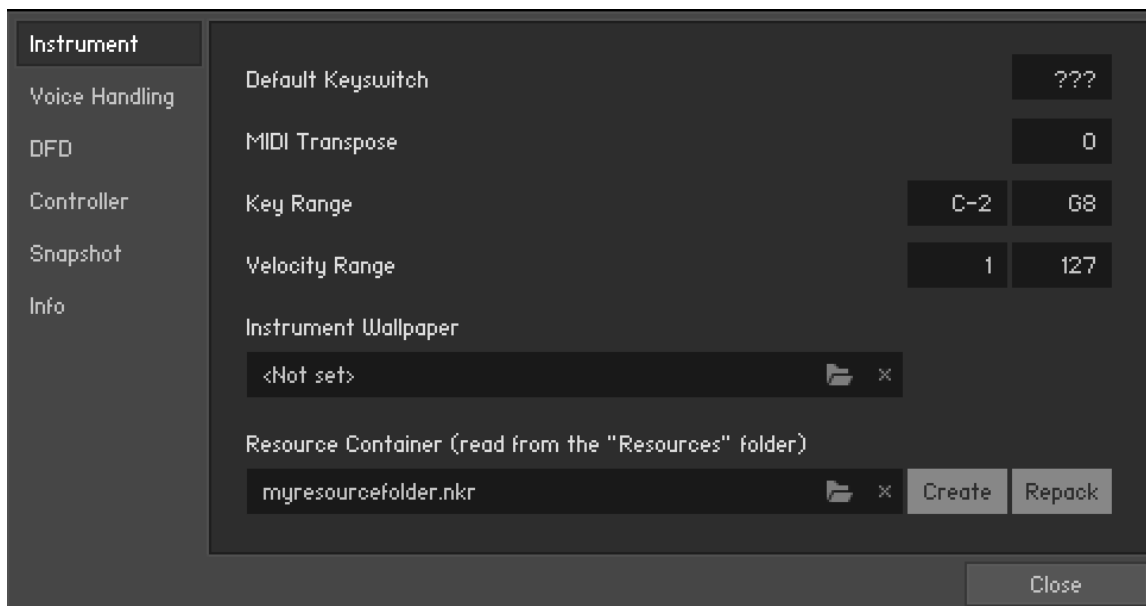

- **Key Switch default Key:** If you have defined any keyswitches for your Instrument, this value specifies the default switch that will be active right after the Instrument has been loaded.
- **MIDI Transpose:** This parameter allows you to apply a transposition offset to all incoming MIDI notes. In contrast to the **Tune** knob in the Instrument Header, which alters the pitch of the sample playback, this value will change the MIDI notes only; for instance, a setting of 12 will have the same effect as playing an octave higher.
- **Key Range:** The keyboard range to which this Instrument will respond. Setting this parameter to different ranges across multiple Instruments is a quick way to create keyboard splits.
- **Velocity Range:** Limits the velocity range to which this Instrument will respond.
- **Instrument Wallpaper:** To give your Instruments a distinctive appearance in the Rack, you can create your own skins. This parameter lets you choose an image file in TGA or PNG format that will be used instead of the default panel background of the Instrument Header at its normal size. The image needs to have a color depth of 16, 24, or 32 bits and should be 633 pixels wide — larger widths will be cut off, smaller widths will be filled with black. We have included some sample skins in the Kontakt installation.

After you have added a skin to your Instrument, we recommend that you save it once with samples; this will put the skin image file into a “wallpaper” sub-folder inside the Instrument’s sample folder.

- **Resource Container:** Now that Kontakt libraries can link to many different types of files, the Resource Container was designed as a tool for library developers to help them keep all of these files in a convenient location. In this area you can **Create** a Resource Container, or attach an nki to an existing one via the browse button.
- **Repack:** Only shows when a resource container is assigned to the loaded instrument. Allows you to repack your resource container if you have made changes to the instrument within Kontakt.

## Voices Handling Tab

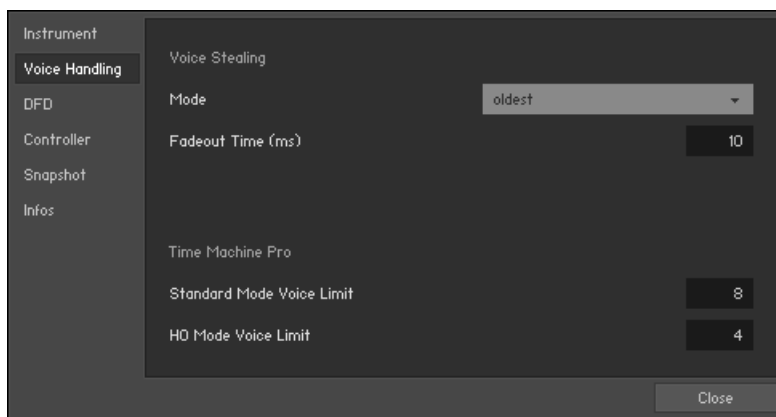

## Voice Stealing

This section contains options for setting how the instrument should react when it starts to exceed its voice limit.

- **Mode:** This sets the default way in which Kontakt will free up voices when the Instrument’s maximum voice count has been reached. These options are explained in section [Voice Groups](#).
- **Fadeout Time:** When Kontakt has to recycle a voice, it won’t just cut it off abruptly, but apply a short fade-out; this eliminates clicking noises. This parameter adjusts the length of the fadeout in milliseconds.

## Time Machine Pro

In order to produce high quality time and pitch manipulation, the Time Machine Pro machine mode uses more resources than the other machine modes. As such, the number of voices it can process at any one time have their own limits, separate from the main Instrument voice limit. These limits are set in this section.

- **Standard Mode Voice Limit:** Sets the voice limit for groups using the standard quality Time Machine Pro mode.
- **HQ Mode Voice Limit:** Sets the voice limit for groups using the **HQ Mode** option in Time Machine Pro.

## DFD Tab

In the DFD Tab you can access the options for Direct From Disk streaming. This allows Kontakt to read samples directly from the Hard Drive, and only load a small section of the sample in RAM, reducing the overall RAM usage of the Instrument.

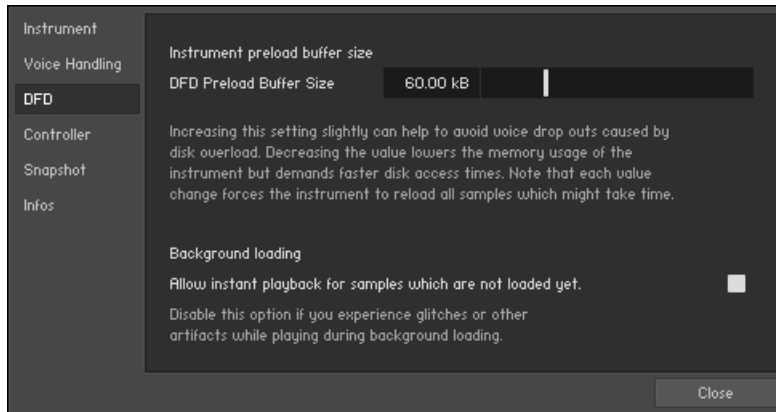

- **DFD Preload Buffer Size:** With this slider, you can adjust the size of each Sample portion that will be buffered in memory for instant playback. This value applies only to Samples that belong to Groups whose Source Module is operating in DFD mode. If any Group in DFD mode causes drop-outs which disappear when you put the respective Source Module into **Sampler** mode, you might want to try increasing this parameter.
- **Background loading:** The Background loading option **Allow instant playback for samples which are not loaded yet** is available here. Enable this option to have Kontakt play every triggered note during Background Loading. Under certain special circumstances, playing notes while loading samples in the background may cause 'flam'-like glitches or other unexpected audio artifacts as Kontakt attempts to play a sample it has not yet loaded. Disable this option to avoid such artifacts.

## Controller Tab

This tab contains the options for how the instrument should react to certain standardized MIDI controller messages.

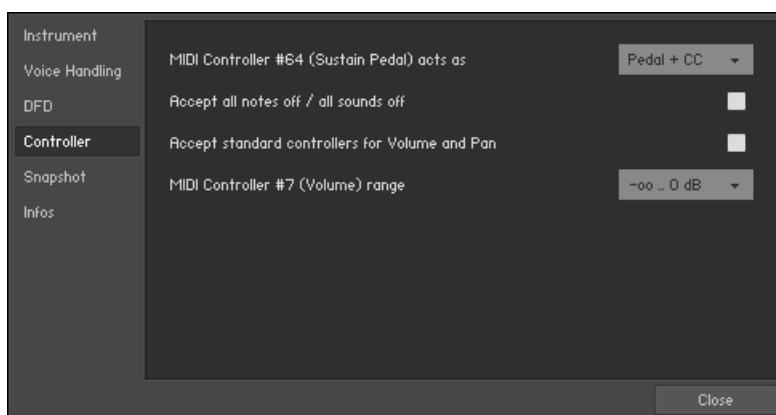

- **MIDI Controller #64 (Sustain Pedal) acts as:** You can choose how Kontakt should interpret and handle incoming MIDI controller #64 messages, which are usually being sent by sustain pedals:
  - **Pedal + CC** will keep the Instrument in its sustain phase as long as the sustain pedal is depressed, and also treats the message like a normal MIDI controller (which allows you to use it as a modulation source).
  - **Sustain Pedal without Controller** will keep the Instrument in its sustain phase as long as the sustain pedal is depressed, but the message will not be available as a normal MIDI controller.
  - **Controller Only:** Kontakt won't use sustain pedal messages for sustaining notes, but you will be able to access them as MIDI controllers for your own purposes.
- **Accept all notes off / all sounds off:** When activated, Kontakt will interpret and adhere to incoming "all notes off" MIDI messages.
- **Accept standard controllers for Volume and Pan:** When activated, you can change the output volume and pan settings of an Instrument by sending MIDI CCs #7 and #10, respectively. These are the standard controller numbers for volume and pan.
- **MIDI Controller #7 (Volume) range:** This drop-down menu lets you choose how the value range of MIDI CC #7 controller messages will be mapped to the output volume slider if the previous option is activated. The selected range endpoints correspond to the volume levels at MIDI values 0 (minimum) and 127 (maximum), respectively. The default setting is **negative infinity .. 0dB**, which mutes the Instrument at controller value 0 and puts it at unity gain at controller value 127.

## Snapshot Tab

Snapshots are a way of saving any processing related information associated with an Instrument, without the need to save the whole instrument. For example, if you want to create an Instrument with some synthesizer samples, and then save a version of that same Instrument with a low pass filter applied, you can save that filtered version as a Snapshot.

In the Snapshot Tab you can view the locations of the Snapshot files associated with the Instrument.

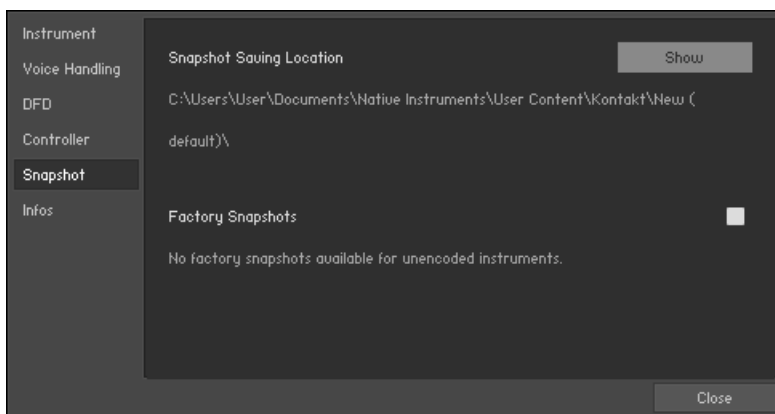

- **Snapshot Saving Location:** This area will display the location on your computer where the user Snapshots for this Instrument will be saved to and loaded from. Clicking on the Show button will open this folder in your operating systems file browser.
- **Factory Snapshots:** Some 3rd Party libraries will come with their own Snapshots, which cannot be overwritten. These Snapshots are stored in a separate location, which you will be able to see here. You can toggle the availability of factory Snapshots by clicking the button to the right of this section.

## Info Tab

The Info tab of the Instrument Options dialog contains information about the selected instrument and provides editable parameters to document additional information. If the Instrument is from a third-party library, then it will display information about the library and will not be editable.

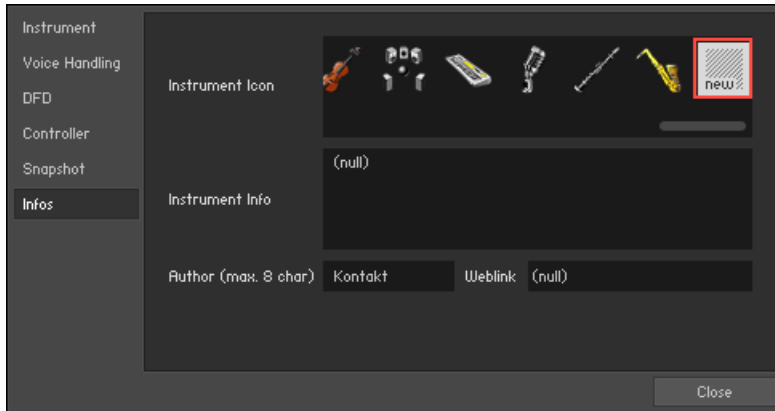

- **Instrument Icon:** Kontakt allows you to assign icons to your Instruments; these will be displayed within normal-sized Instrument Headers in the Rack and provide visual hints about the Instrument category. The rightmost icon in the list, labeled **new**, is the default icon for newly created Instruments. Note that Kontakt will assign special icons to Instruments that were imported from third-party formats; these don't appear in this list.
- **Instrument Info:** Use this text field to enter any information, credits, or production notes you'd like to be attached to your Instrument.
- **Author:** When you have created an Instrument and want to distribute it, you can enter your own or your company's name here.
- **Weblink:** This field lets you provide a web location where people can find more information about you and your Kontakt creations.

## Loading and Creating Instruments

Loading and Creating Instruments in Kontakt can be done in a number of ways. Using the Files menu, Instruments can be loaded and created, and the default Instrument template saved.

### Loading Instruments

You can also load an Instrument to your Multi, either in Kontakt format (.nki) or in one of the supported third-party formats from the Side pane. You can either:

- Drag the Instrument into a blank space of the Rack to add it to the Multi.
- Drag the Instrument onto an Instrument already loaded in the Rack to replace it with the new one.
- Alternatively, you can choose the **Load** command from the Files menu; a file selection dialog will appear that lets you locate and select any Instrument, Multi, or Instrument Bank file on your system.



If you have activated the Side pane **Double click loads instrument** option in the **Options** dialog, you can also load Instruments by double-clicking them in the Side pane.

After the Instrument has been loaded successfully, it will appear in the Rack. If required, you can now change its Output and MIDI channel assignments from the controls in the Instrument's Header. Once these are correctly set, you should be able to play the Instrument via your MIDI keyboard or the virtual on-screen keyboard.

## Creating Instruments

If you would like to create an Instrument from scratch, you have the following options:

- Use the **New Instrument** command in the Files menu to add an empty Instrument that's based on the default Instrument template. You can change this template by creating a default Instrument of your choice and saving it via the **Save as Default Instrument** command in the Files menu.
- Alternatively, start out with a Sample or a set of Samples and let Kontakt do the work of combining them into an Instrument. Locate and select the Sample files that you want to use in the Side pane, then drag them into an empty space in the Rack. Kontakt will create a new Instrument based on the default Instrument template and spread the Samples across the keyboard. If you do this with a WAV file that contains Slice markers or with a REX file, Kontakt will switch the new Instrument to Beat Machine mode, so that you can play your Sample in sync to your song tempo right away.

In Classic view the File menu contains the following additional options for creating new instruments:

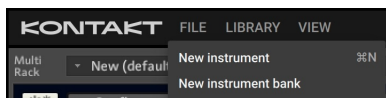

- **New instrument:** Adds a new Instrument to your Multi. Whenever you create a new Instrument, Kontakt will use a default Instrument file as a template, which is usually empty. Overwriting this file with your own version allows you to define your own default settings. For example, you might want new Instruments to contain a Send Levels module in their Instrument Insert Effects chain by default. To set this up, create a new Instrument, insert the module into its chain, and select Save as default instrument from the Save menu while the Instrument is open for editing.
- **New instrument bank:** Adds an empty Instrument Bank to your Multi. Instrument Banks are described in detail in section [Instrument Banks](#).

## Saving instruments

The entry **Save as** in the Header's **File** menu allows you to save any Instrument in your Rack as an .nki file for later reuse. When you select this entry, a sub-menu will open that contains a list of all Instruments in your current Multi. Selecting one of them opens a Save dialog that allows you to choose a location and change the name of the Instrument. Note that the file name, without the .nki extension, will be used as the Instrument name that is displayed in the Instrument Header.

Below the file selector, the dialog lets you choose how Kontakt should handle the Samples that are being referenced by the Instrument. When you have added these Samples to your Instrument during your current session, they're still in their original location, and the Zones in your Instrument reference them via their full paths; the various options in the save dialog allow you to fine-tune this behavior before your Instrument is written to disk.

The file dialog offers the following options for saving samples along with the instrument:

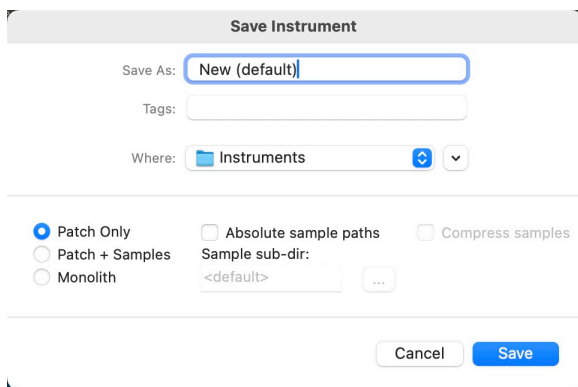

- **Patch Only:** Keeps samples in their original locations and only saves file references in the instrument file. This achieves small file sizes, however moving references samples on the hard drive will result in missing samples. For more information, refer to [Samples Missing dialog](#).
  - If you activate **Absolute Sample Paths** for the **Patch Only** option, the Sample files will be referenced by the Instrument with their absolute paths. In this case Kontakt will find the files even if you move the Instrument file to a different location. When deactivated, the samples must stay in the same path relative to the instrument in order to be found.
- **Patch + Samples:** Saves the .nki file and copy the contained Samples to a new location, changing the file references within the Instrument to the copies in the process. If you leave the Sample Sub-Folder option below set to its Use Default value, Kontakt will save the Sample files to a Samples folder inside the destination location of your Instrument file; this folder will be created if it doesn't exist yet. That way, the Samples will be kept close to the Instrument, which helps you keeping track of them when doing backups or moving directories. You can also specify a different Sample location, though; for example, you might want to use a common Samples folder that resides in the directory of your project.
- **Monolith** will combine the Instrument and its referenced Samples into a single, large file. This is the safest option to choose in terms of keeping Sample references intact, as the Samples cannot accidentally get separated from the Instrument later. This is also a good way to create Instruments that should be distributed to other users of Kontakt.

Should you choose to save the referenced Samples along with your Instrument data by selecting either Patch + Samples or Monolith, you further have the choice to save them in a Below the file selector, the dialog lets you choose how Kontakt should handle the compressed format by checking the box below the sub-folder field. In this case, Kontakt will write the Samples using a proprietary, lossless audio codec that typically yields compression rates between 30% and 50%. This will not only improve access performance when streaming the Instrument from disk, but will also reduce its memory footprint, as Kontakt will decompress the Samples on-the-fly from memory with very little CPU overhead. The downside of using compressed Samples, however, is that you cannot use external wave editors to access them directly anymore.

When you are using Kontakt as a plug-in inside your host program and save your session, all Multi and Instrument data will be included in this session file. Sample references will be saved in an absolute fashion, so you may get a Samples Missing dialog when you open the session after you have moved your Samples. In the Loading tab of the Options dialog, you can specify a base path for your Non-Player content, and also choose if you want to store referenced paths relative to the base path. When a host project is saved with this option selected, Non-Player content will be able to resolve without the Missing Content dialog, if the libraries are located on the computer's path as defined in the base path field. This makes it easy to share session files with Kontakt instances across platforms. For more information, refer to [Loading](#).



**i** It's important to keep track of the ways the Sample and Instrument files on your hard disk relate to each other; this protects you from unpleasant surprises when you move files around, delete them, or recover Kontakt data from a backup.

## Saving instruments when editing

When you edit an instrument, the following options are available in the File menu:

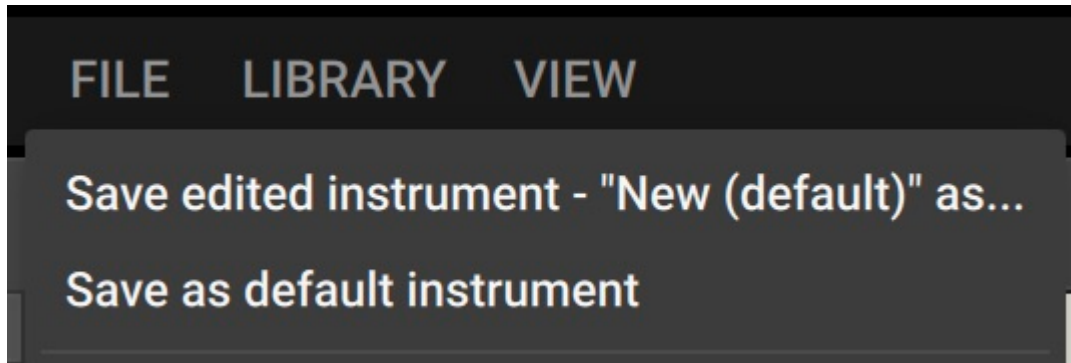

- **Save edited instrument "instrument name" as...:** Opens the file dialog for saving the currently edited instrument.
- **Save as default instrument:** This command is only viewable when you are editing an instrument. It saves the selected Instrument as your default one so whenever you create a new Instrument, either via the **New Instrument** command of the **Files** menu, or by dragging Samples from the Side pane into the Rack, Kontakt will use this Instrument as a template.

## Batch resave

Kontakt Instruments that include references to external Sample files can cause problems if either the Instrument or the Sample files are being moved to a different location. In such cases, you will be presented with a Samples Missing dialog that asks you in which places Kontakt should look for the missing files (refer to [Loading and Creating Instruments](#)). While it's not a big problem to let Kontakt locate the Samples of one or two Instruments via this dialog, and then re-save them afterwards in order to make the changes permanent, the described effect will be worsened by an order of magnitude if it occurs with a whole library. This can happen if you move the library folder or its contained sub-folders around, and makes it very tiresome to access the library, as every attempt of loading an Instrument will be answered with a Samples Missing dialog.

To fix the problem manually, you would have to load each Instrument, locate the missing Sample files via the Samples Missing dialog, and re-save the Instrument to its original location within the library folder. For large libraries, this is unfeasible. The **Batch Re-save** function automates this process; when you select it, a selection dialog will appear, asking you to choose a folder. After clicking **Choose**, all Instrument, Multi, and Bank files in this folder and its sub-folders will automatically be scanned for unresolved Sample references; if any are found, the Samples Missing dialog will appear once, allowing you to specify which places should be searched to resolve the references. Once Kontakt has successfully located the Samples, the affected Instrument, Multi or Bank files will be re-saved with corrected references, so afterwards, you'll have a consistent library again.

**i** As the Batch Re-save process will overwrite the Instrument, Multi, and Bank files within your selected folder, it's recommended to make a backup of this folder before you execute the command.

## Collect samples / Batch compress

**Collect samples/Batch compress:** If you are working with a library of NKIs that are referencing samples in multiple locations, or you wish to compress (or even de-compress) the samples of a library, this function allows you to compile samples, instruments, banks and multis into a single location.

When you select this option, a dialog box will appear. Here you must select a source folder (where your nki, nkb and nkm files are currently located) and a destination to which you wish to have these files compiled and copied to.

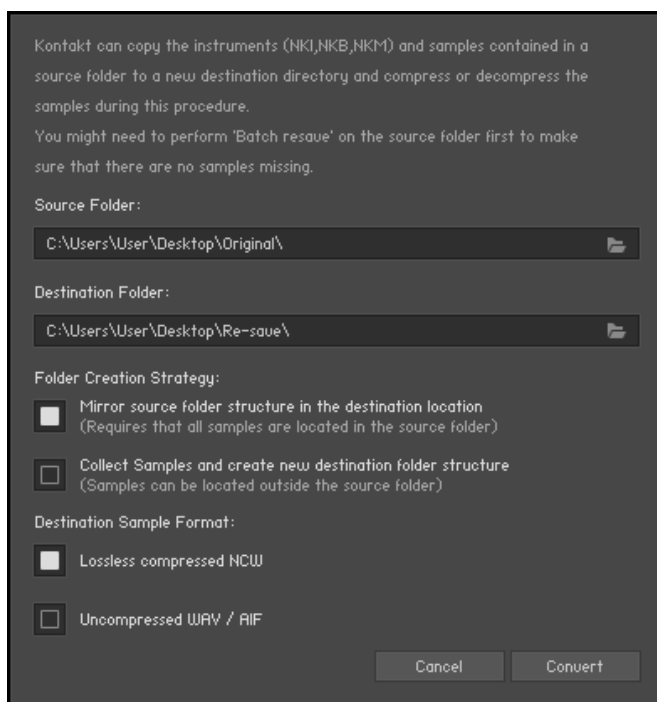

There are two different strategies for creating folders:

- **Mirror source folder structure in the destination location:** This mode keeps the folder structure of the source folder when generating the destination folder structure, so there are no explicit "Instruments" and "Collected Samples" subfolders in the destination folder when using this mode. When batch-compressing a source/library folder and there is an Instrument in the library folder that references a sample outside the source/library folder (and its subfolders), a "Collected Samples" subfolder will be generated for saving the samples in the destination folder.
- **Collect Samples and create new destination folder structure:** In this mode the folder substructure of the target folder will be different from the source folder's structure: Instrument files will be saved in an "Instruments" subfolder, while all samples are saved in "Collected Samples". This prevents having to resave the same sample more than once (if it was referenced by more than one Instrument in the source folder for instance).



Whichever strategy you choose, samples and Instruments in the source folder will neither be deleted nor updated. Impulse Response samples and wallpapers of the source Instruments will be re-saved as well, but without compression.

You can choose between two options for the destination sample format:

- For converting uncompressed samples to lossless compressed .ncw-files select **Lossless compressed NCW**.
- For converting compressed .ncw-files back to an uncompressed format select **Uncompressed WAV / AIF**.



Note that Batch Compress does not work for copy-protected libraries.

## Global purge

Global purge keeps track of which samples in an instance have been actually triggered in a session, and gives you the option of removing all other samples from the Instrument. This way, you can reduce the number of samples that are being kept in memory to the subset that you have actually used in your arrangement. Place your mouse over this entry in the Files menu to open a submenu with options for sample purging and loading.

The Global purge sub-menu contains four entries:

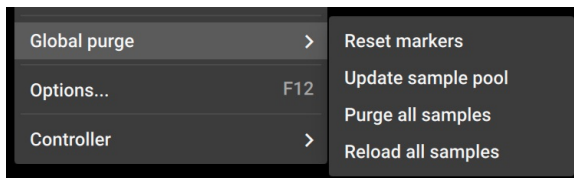

- **Reset markers:** Whenever Kontakt plays a sample in any of your Instruments, it will flag the respective sample as being used. Using this function, you can delete all of these flags, thereby resetting all data that Kontakt has gathered about sample usage so far. After you have finished your work on a part, you should select this function once and then play your part; this way, only the notes that have actually made it into the final part will be flagged as used. Afterwards, you can proceed by choosing the **Update sample pool** function described below.
- **Update sample pool:** This function removes all samples that are not currently flagged as being used from memory, and reloads any currently purged samples that have been triggered since the last purge operation. In other words, it brings the sample pool in sync with the sample usage flags it has gathered since the last purge operation.
- **Purge all samples:** Unloads all samples from RAM. This allows you to reverse the usual purge process: you can play your arrangement in a “silent run”, and then load only the Samples that are actually being used via the **Update sample pool** command afterwards.
- **Reload all samples:** Reloads all Samples, reverting any previous purge actions.



You can also purge samples per Instrument using the Purge menu in the Instrument Header. See [Purge menu](#) for more information.

## Samples Missing dialog

Kontakt uses different ways to reference the Samples that are being used by an Instrument. When Instruments are being saved in a monolith, the Sample data gets embedded in the file itself, and thus can't be accidentally separated. In a lot of cases, though, you will encounter Instruments that reference external Sample files on your system via their respective paths and file names. It's obvious that while this method creates small Instrument files and avoids unnecessary duplication of Sample data, it's not as bullet-proof as combining Instrument and Sample data into a monolith; whenever you move referenced Sample files to a different location, Kontakt won't be able to find them anymore in the location that's being specified within the respective Instrument files. Depending on whether Kontakt used a relative path for referencing Samples, this can even happen when you move Instrument files while keeping their referenced Samples in their original locations.

Whenever you attempt to load an Instrument whose Samples cannot be found in their expected location, Kontakt will open a Content Missing dialog. This window offers various options that help Kontakt locate the missing files on your system. Once it has found them, you can then re-save the Instrument with the corrected references in order to make the changes permanent.

The Content Missing dialog contains the following options and features:

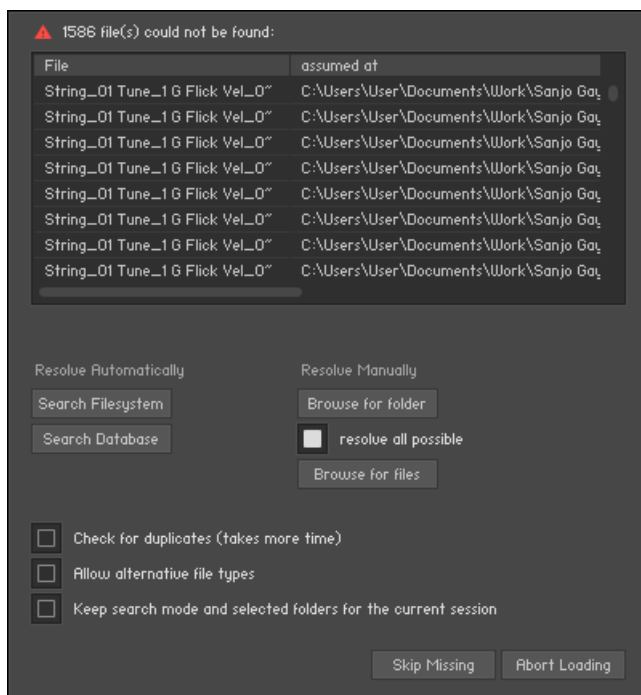

- File Display:** In its upper half, the Content Missing dialog displays a list of all Sample files that were referenced within the Instrument file, but couldn't be found in the expected locations; these locations are shown in the right column. Whenever you're not sure which action might have caused the Content Missing dialog to appear, study the locations displayed in the **assumed at** column carefully; you might recognize a folder that you've moved to a different location at some point in the past.

- **Resolve Automatically:** In the lower half of the dialog, Kontakt provides a number of commands that will either search for the missing files automatically (left side), or allow you to specify the new location manually (right side). If you're not sure where the missing Samples could be located, choose one of the automatic options on the left side:
  - **Search Filesystem:** This will search for the missing Samples on all file systems of your hard disks. Depending on the size and speed of your hard disks, the scanning process might take a considerable amount of time, but if the Sample files have not been renamed or deleted, they will eventually be found.
  - **Search Spotlight:** Spotlight in macOS's indexed "search" function built into the OS. (Unless disabled) it's always running in the background updating file locations which means that if you use the search spotlight feature it resolves missing sample conflicts immediately
- **Check for Duplicates:** By default, all these options search for the missing Samples by their file names only; in some cases, two or more different Samples on your hard disk might share a common name. This can cause Kontakt to load the wrong Sample; if you notice this in your Instrument, don't save it. Instead, remove it from your Multi, load it again, and repeat the search process after you've activated the **Check for Duplicates** option at the bottom of the Samples Missing dialog. This will make Kontakt examine any files with matching names more thoroughly, which will sort out duplicates, but take more time than searching without this option.
- **Resolve Manually:** If you already know where the missing Samples are located on your system, there is no need for an automatic search. Instead, choose one of the options on the right side, which allow you to locate files manually:
  - **Browse for Folder:** When you click this button, a folder selection dialog will appear. After you've located and chosen a folder, Kontakt will look for the missing Samples inside this folder and all of its sub-folders.
  - **Browse for Files:** This option will ask you to locate each missing file manually, one at a time, via a file selection dialog. During this process, the name of the currently searched file will be displayed in the title bar of the selection dialog window.
  - If the **resolve all possible** option is activated, Kontakt will look for all missing Samples in each location that you specify via the Browse for Folder or Browse for Files option. If it's deactivated, you will be asked to provide a location for each missing file separately.

Once you have selected the appropriate search action, Kontakt will start the file scanning process. During this scan, the missing Sample list will shrink whenever a Sample has been successfully located. Once all Samples have been found, the dialog will disappear and the Instrument will be loaded into your Rack. You should now make sure that it works correctly and then re-save it to its original location with the **Save as...** command in the Files menu.



If you have moved a whole library, and the Samples Missing dialog appears each time you attempt to load an Instrument from this library, you don't need to click through the Samples Missing dialog and re-save the Instrument each time; the Batch Re-Save command in the Files menu allows you to locate the referenced Samples of all Instruments below a folder at once and re-save all of them automatically. This command is explained in section [Handling](#) of this manual.

If there are still missing Samples after the scanning process, the Content Missing dialog will reappear, which allows you to try another search option. If each attempt to locate the missing Samples fails, they either don't exist on your system anymore, or have been renamed. In such cases, you can choose to either abort loading the Instrument by clicking the right button at the bottom of the dialog, or load the Instrument without the missing Samples with the left button.

- **Allow alternate file types:** This option allows you to ignore the audio file extension and resolve missing samples with alternative file types with the same name. For example, if you had an instrument which referenced uncompressed WAV files, but at some point you compressed the files to NCW format, you can reference the NCW files in place of the WAV files.
- **Keep search mode and selected folders for the current session:** If you are opening multiple Instruments that could require searching for Samples in the same location, checking this option will tell Kontakt to repeat the search mode for any newly opened Instrument while you are still running the same session. Closing and reopening Kontakt will reset this option.

## Instrument Banks

An Instrument Bank allows you to combine up to 128 Kontakt Instruments into one slot of your Rack. Only one of the Instruments in a Bank can be active at any time, and you can switch between them by sending MIDI program change messages. All Instruments in a Bank will share the same MIDI channel, Output Channel, maximum note count value, output and pan settings, and Aux send levels. You can adjust these settings in the Bank Header, which appears in the Rack and resembles an Instrument Header in structure.

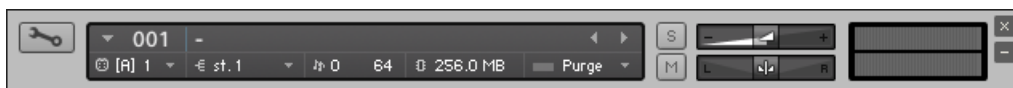

As an example, an orchestral sampling library provides numerous articulations and playing techniques for each instrument, which are split up into a number of Kontakt Instrument files. For instance, the “Solo Flute” folder might contain the four files “Flute sustain.nki”, “Flute staccato.nki”, “Flute halftone trill.nki” and “Flute flutter tongue.nki”. Although you could just add these Instruments to your Rack and assign them to different MIDI channels, this is not the most efficient option if you are planning to use only one Solo Flute in your arrangement. You do not require multiple articulations at the same time, and you are wasting three MIDI channels and three of your 64 available Instrument slots. Instead, you could create a “Flute” bank and insert all articulations you will need into its slots; this allows you to switch between these articulations by sending MIDI program change messages. This workflow is closer to the way you’d interact with a real flutist; in order to get him to adapt his playing style to your music, you need to add expression, dynamic and articulation marks, as well as playing directions, to your sheet music.

Some notation programs allow you to specify how different articulation, expression, dynamic, and playing direction marks in your score will be translated when played back via MIDI. Assigning these items to MIDI program changes that correspond to the respective Instruments in your bank allows you to create very sophisticated setups and produce realistic mock-ups from your scores instantly without any further MIDI optimization. Refer to the manual of your notation program to find out whether it supports this method. Similarly, you can create MIDI program changes at specific places of your sequences in any MIDI sequencer program.

## Creating Instrument Banks

To add a new, empty Instrument Bank to your current Multi:

- Select **New instrument bank** from the Files menu.

→ A new Bank Header will appear in the Rack.

The Bank Header controls are similar to that of an Instrument Header, but apply to all contained Instruments. In its name field, the Bank Header will display the name of the currently active Instrument.

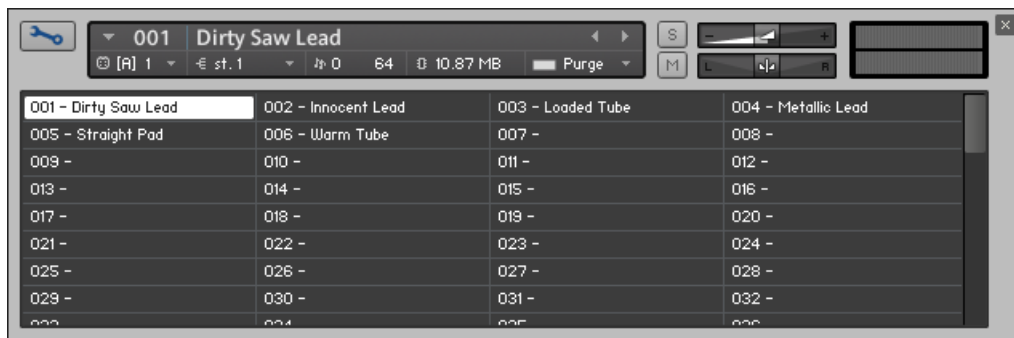

To assign Instruments to a Bank:

1. Click the wrench icon in the upper left corner of the Bank header to open the Instrument slot list. A list of 128 Instrument slots will appear.
2. Drag an Instrument (.nki) file from the Side pane into a slot of the Instrument Bank to load the Instrument into this slot.
3. Set the number in the slot field to indicate the program change number that will switch to this Instrument; in the example shown above, incoming notes on the Bank's MIDI channel will trigger the Dirty Saw Lead Instrument in slot 001 (this is being indicated in the name field of the Bank Header); sending a MIDI program change with a value of 2 will switch over to the Innocent Lead Instrument, which will then stay active until the Bank receives a new program change message. Alternatively, you can click on the Instrument names in the Bank to change the selected Instrument.

To edit an Instrument inside a Bank

1. Double-click on the respective slot to put your Rack into Instrument Edit mode.
2. Make your adjustments, then return to Multi Instrument mode by clicking the wrench icon in the upper left corner of the Rack. Clicking the **x** button in the upper right corner will remove the whole Bank from your Multi. Also note that the modified Instrument can only be saved within the Bank file; there's no way to save it to a separate Instrument file.

## Loading and Saving Instrument Banks

Instrument Banks and their contents will be loaded and saved along with your Multi, but you can load and save them separately as well. Kontakt Instrument Bank files are indicated with the extension .nkb. You can load these in the same way as you load Instruments.

To load an Instrument Bank:

1. Double-click the Instrument Bank or drag it from the Side pane into an empty space of your Rack,
2. Alternatively, use the **Load** command in the Files menu.

## Using Snapshots

Snapshots offer a way of saving and exploring variations of any Kontakt Instrument for easy recall. Take, for example, the NI Abbey Road Drummer products; each comes with a fully-featured mixer including separate channels for each drum component, as well as built-in effects. Using Snapshots, you can create any number of mixes for the same Instrument, save them in the .nksn file format and use them in other projects, across computers or even share them with other users.

To access the Snapshot View:

- ▶ Click the camera icon in the Instrument Header. You can switch back to the familiar Info View with its Input / Output configuration options by clicking the **i** icon.

## Overview of Snapshots

Snapshots contain the following key features:

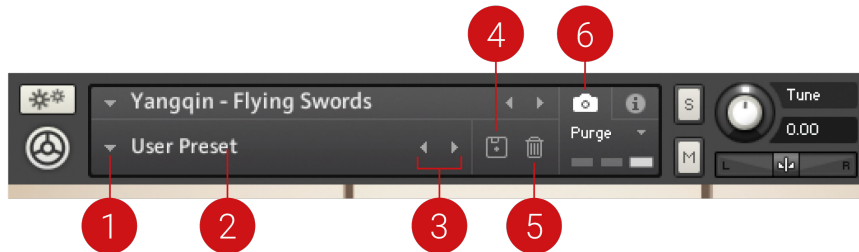

1. **Load Snapshot:** Opens the Snapshot menu where you can load a Snapshot from the **Factory** and/or **User** library. For more information, refer to [Loading a Snapshot](#).
2. **Snapshot Name:** Displays the name of the currently selected Snapshot.
3. **Snapshot Previous/Next** (<> icons): Enables you to quickly browse and load Snapshots. Pressing an arrow icon will load the previous or next Snapshot in the selected category. If no Snapshot is active, the first Snapshot on the list will be loaded. For more information, refer to [Loading a Snapshot](#).
4. **Save Snapshot** (floppy disk icon): Enables you to save changes made to a sound. When a User Snapshot is saved, the setting and parameter controls are stored within it and can be accessed at any time via the **User** library. For more information, refer to [Saving a User Snapshot](#).
5. **Snapshot View** (camera icon): Provides access to the Snapshot features described above; saving, loading, browsing, and deleting. When **Snapshot View** is selected, configuration settings and features relating to the **Info View** are replaced in the display.

## Saving a User Snapshot

Snapshots can be saved at any time while you are working on them. By loading a Factory Snapshot and adjusting some of its parameters, you can then save a User Snapshot. The Kontakt Factory Library does not come with Snapshots, so in order to demonstrate the full feature set, first save a Snapshot.

### Save a User Snapshot

To save a Snapshot:

1. Click the Snapshot View button (camera icon) to open Snapshot view.
  2. Click the Save button (floppy disk icon).
  3. Enter a name for your new Snapshot in the **Save** dialog box.
  4. Click **Save** to finish the process and close the dialog box.
- Your Snapshot .nksn file is saved to the User Snapshot Library. It appears in the **User** Snapshot list.

## User Content Folder

All User Snapshots are automatically stored in the default User Content folder:



<b>Mac OS X:</b>	<i>Macintosh HD/Users/&lt;User Name&gt;/Documents/Native Instruments/User Content/Kontakt Factory Library/Electric Grand/Triple Peaks.nksn</i>
<b>Windows:</b>	<i>C:\Users\&lt;User Name&gt;\My Documents\Native Instruments\User Content\Kontakt Factory Library\Electric Grand\Triple Peaks.nksn</i>



You can transfer any of your Snapshots to another computer by copying the respective Snapshot files.



Make sure you include your *Documents/My Documents* folder in your regular data backups.

## Loading a Snapshot

Snapshots are loaded from the drop-down menu in the top header of the instrument. You can also use the Browse arrows to load the previous or next preset. Some Instruments contain a collection of Factory Snapshots, while other Instruments only facilitate User Snapshots.

### Load a User Snapshot

To load a Snapshot from the menu:

1. Click the Snapshot View (camera icon) to open Snapshot view.
2. Click the arrow icon next to the Snapshot name field to open the Snapshot menu.
3. Select the **User** category (if available).
4. Click a Snapshot to load it.

→ The loaded Snapshot is displayed in the instrument header.

### Load a Factory Snapshot

Factory Snapshots are only available for Kontakt Player Libraries, so this section only applies if you own Komplete 9 or a Kontakt Player library released after Komplete 9. Some of the Komplete Libraries seem minimalistic at first glance, but the true sound design potential can be tapped by tweaking the parameters available on the Instrument's user interface. Our sound designers aim to create inspiring Snapshots that showcase the range of sounds available from just one instrument.

To load a Factory Snapshot:

1. Click the Snapshot View (camera icon) to open Snapshot view.
2. Click the arrow icon next to the Snapshot name field to open the Snapshot menu.

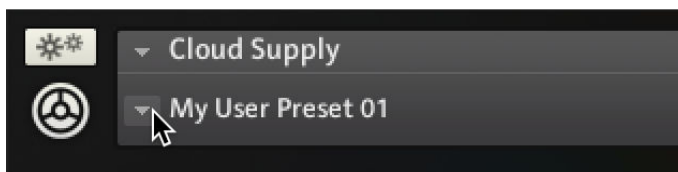

3. Select the **Factory** category to load a Factory preset (if available), or select the **User** category to load one of your own snapshots.



4. Select an instrument category (if available).

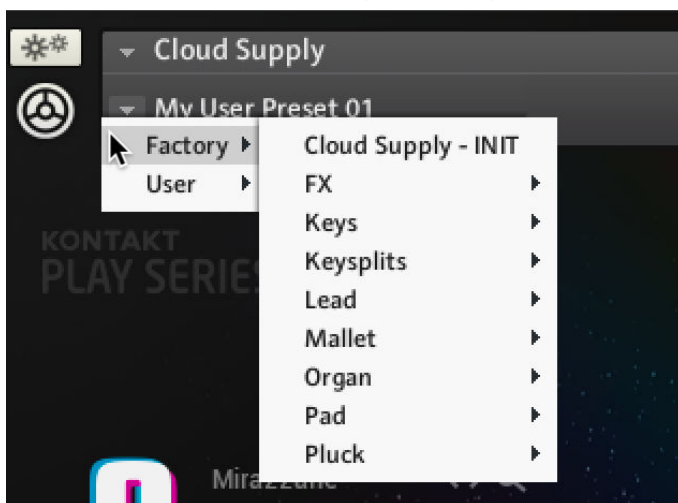

5. Click a Snapshot to load it.

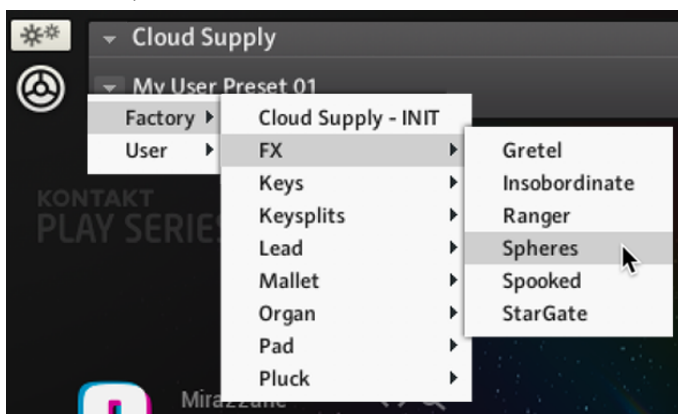

→ The loaded Snapshot is displayed in the instrument header.

## Browser Arrows

To load and browse Snapshots using the arrows:

1. Click the Snapshot View (camera icon) to open Snapshot view.

- Click the arrow icons (<>) in the Snapshot header to browse through the Snapshots list.

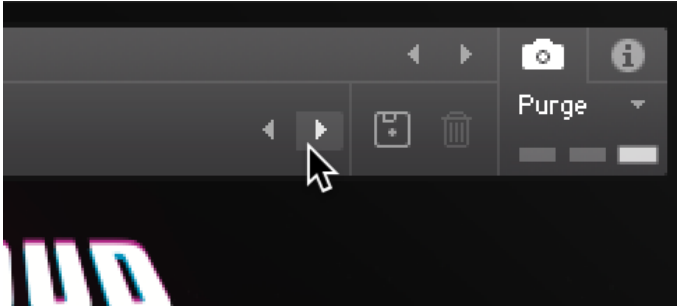

→ The previous or next Snapshot will load immediately each time an arrow icon is clicked.

**i** Note that the **User** category will not appear until you have first saved a Snapshot.

## Loading a Snapshot from the File System

Kontakt supports two ways of loading Snapshot files (.nksn) from your file system. This enables you to use your favorite Snapshots without altering the installation on the studio computer.

### Drag and Drop

To load a Snapshot from any disk:

- Open Kontakt .
- Locate an .nksn file in your file system.
- Drag the file from its current location onto an empty area of the Rack.  
If you drag a Snapshot onto an active Instrument in the Rack, it will be replaced by the Instrument loaded from the Snapshot.

→ Kontakt will load a new instance of the corresponding Instrument with the selected Snapshot.

### Double-click

- Open Kontakt.
- Locate an .nksn file in your file system.
- Double-click the Snapshot file in the Finder (Mac OS X) or File Explorer (Windows).

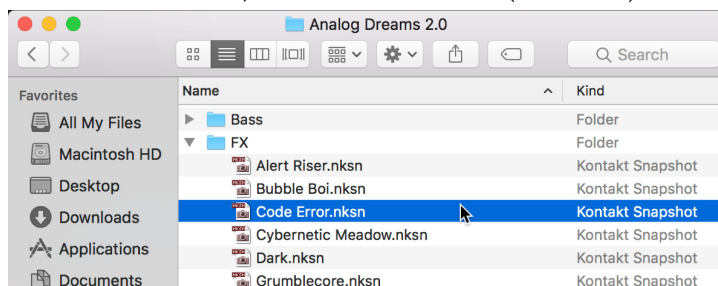

→ A new Instrument instance is inserted in Kontakt and the Snapshot is loaded.

**i** A Snapshot is not automatically saved to the default location when you open it, so it will not be available in the Snapshot menu.

## Saving and Loading Presets

Presets allow you to save your settings in any part of Kontakt and recall them in another context. The Kontakt environment is split up into modules, and most of these offer a preset drop-down menu that allows you to manage presets for the respective module. Loading a preset in a module does not affect the other modules in your Instrument, allowing you to freely combine different presets into your own Instruments.

Presets are saved in files (file extension: .nkp) which reside in a series of sub-folders within a "presets" folder. Kontakt creates two of these preset folders on your system: one contains the factory presets and is located in a directory which is not writable by normal users; the other one resides within your home directory and will be used to store your own custom presets. Kontakt will create this user presets folder when you first start it up.

Factory and user preset folders will be created in the following folders:

<b>Windows Factory</b>	<i>C:\Program Files\Common Files\Native Instruments\Kontakt 7\presets</i>
<b>Windows User</b>	<i>C:\Users\[username]\Documents\Native Instruments\Kontakt 7\presets</i>
<b>Mac OS X Factory</b>	<i>Macintosh HD/Library/Application Support/Native Instruments/Kontakt 7/presets</i>
<b>Mac OS X Users</b>	<i>Macintosh HD/Users/[username]/Documents/Native Instruments/Kontakt 7/presets</i>

Kontakt provides a large number of ready-made presets for most of its modules, which are good starting points for your own settings. Browse the **Factory** preset list of a module when you have a specific task in mind and don't know where to begin.





Preset management in Kontakt takes place within each module's preset drop-down menu. You can access this by clicking on the drop-down menu labeled **Pre** or **Preset**, which is located on the left side of each module. It contains all preset files that were found in the respective preset folders on your hard disk, with further subdirectories (if any) appearing as sub-menus. The **Save Preset** entry at the bottom of the menu will open a dialog, which asks you for a filename. Enter a descriptive name and click **Save**, and your settings will be available within the **User** submenu of the presets drop-down menu. This will not work, however, if you change the path in the save dialog, so it is recommended that you always save your presets to the default path.





## Classic View Reference



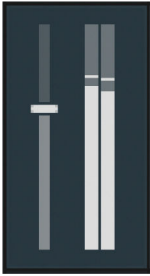

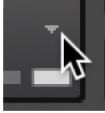
The following chapter describe all the different sections and modules that you can find in Kontakt's Classic View.

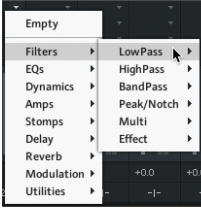
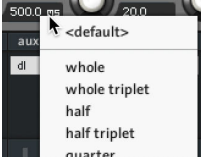
### User Interface Elements

There are a number of common interface elements that are used throughout Kontakt's Classic view. The handling of these common elements is always the same, but the context in which they appear will vary. The following overview highlights the main elements and explains how to interact with them using a mouse.

Name	Example	Description	Interactions
Unipolar Knob with Value Field		Used to adjust parameters in the range of 0% to 100% from left to right.	<ul style="list-style-type: none"> <li>Click + drag up/down to change the control's value.</li> <li>Hold [Shift] while adjusting the knob for fine-tuning.</li> <li>Hold [Ctrl] (Windows) or [Cmd] (Mac OS X) + click to reset the control to the default value.</li> </ul>
Bipolar Knob with Value Field		Used to adjust parameters in the range of -100% to +100% from left to right. The center position is 0%.	<ul style="list-style-type: none"> <li>Click + drag up/down to change the control's value.</li> <li>Hold [Shift] while adjusting the knob for fine-tuning.</li> <li>Hold [Ctrl] (Windows) or [Cmd] (Mac OS X) + click to reset the control to default value.</li> </ul>
Unipolar Slider		Used to adjust parameters in the range of 0% to 100% from left to right.	<ul style="list-style-type: none"> <li>Click + drag left/right to change the control's value.</li> <li>Hold [Ctrl] (Windows) or [Cmd] (Mac OS X) + click to reset the control to default value.</li> </ul>
Bipolar Slider		Used to adjust parameters in the range of -100% to +100% from left to right. The center position is 0%. The value is displayed above the slider control.	<ul style="list-style-type: none"> <li>Click + drag left/right to change the control's value.</li> <li>Hold [Ctrl] (Windows) or [Cmd] (Mac OS X) + click to reset the control to default value.</li> </ul>
Unipolar Slider and Meter display		Used to adjust parameters in the range of 0% to 100% from bottom to top. The meter displays the signal as determined by its respective slider.	<ul style="list-style-type: none"> <li>Click + drag up/down to change the control's value.</li> <li>Hold [Ctrl] (Windows) or [Cmd] (Mac OS X) + click to reset the control to default value.</li> </ul>

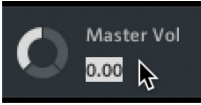
Name	Example	Description	Interactions
Dropdown Menu Arrow		Used to open a dropdown menu relating to the respective control or setting.	<ul style="list-style-type: none"> <li>Click on the arrow to open or close the dropdown menu.</li> <li>Click on any of the available entries to select the option and close the dropdown menu.</li> </ul>
Dropdown Menu Button		Buttons with arrows indicate a dropdown menu. Click the button to open a menu that provides options relating to the respective section or function.	<ul style="list-style-type: none"> <li>Click the arrow button to open or close the dropdown menu.</li> <li>Click on a list entry to select the option and close the dropdown menu.</li> <li>Selected a new value or click elsewhere in the window to close the menu.</li> </ul>
Dropdown Menu and Sub-menus		Some menus have additional sub-menus; these will be indicated with a small right arrow next to the name of the menu item. Moving the selection bar to one of these items will open the respective sub-menu.	<ul style="list-style-type: none"> <li>Move the selection bar to an items to open the respective sub-menu.</li> </ul>
Sync Tempo Menu		Synchronizes time-related parameters to the song tempo.	<ul style="list-style-type: none"> <li>Click the time unit to open the dropdown menu.</li> <li>Click a note value to select it for the parameter.</li> <li>Select <b>&lt;default&gt;</b> to un-sync the control.</li> </ul>
Function Button		A button represents a parameter that can be switched on and off. Each click on a button toggles it between those two states. The current state of a button is being indicated by its background color; if a parameter is activated, its button will be highlighted.	<ul style="list-style-type: none"> <li>Click the button to toggle between the control's active and inactive state.</li> </ul>

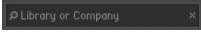
Name	Example	Description	Interactions
Option Button		Opens a menu or dialog with additional options.	<ul style="list-style-type: none"> <li>Click the button to open its menu.</li> </ul>
Tab Button		Switches between two options. Each click on a button toggles between those two states.	<ul style="list-style-type: none"> <li>Click a button to toggle between the two options.</li> </ul>
Banks Tabs		Used to select one of four pages of banks.	<ul style="list-style-type: none"> <li>Click the tab to select it and display it in the Rack.</li> </ul>
Value Field		Some controls contain editable numeric fields that allow you to manually enter values.	<ul style="list-style-type: none"> <li>Double-click the field and enter a new value with the keyboard.</li> </ul>
Value Arrows		Hovering over a value field can display small up/down arrows on right side of the value. Click the arrows to increase or decrease the value incrementally. Only available for some controls.	<ul style="list-style-type: none"> <li>Hover over a value to display the value arrows.</li> <li>Click the up or down arrows to increase or decrease the value incrementally.</li> </ul>
Search Field		Enter names or key words to help search libraries and databases.	<ul style="list-style-type: none"> <li>Click in the Search field and enter a key word. Press [Enter] to search.</li> </ul>
Scroll Bar		Scroll through content using the horizontal and vertical scroll bars.	<ul style="list-style-type: none"> <li>Click on the position indicator bar + drag it to scroll the viewport across the contents.</li> <li>Click on the empty space of a scrollbar to jump to the respective position.</li> </ul>
Checkbox		Used to select and unselect various options and settings.	<ul style="list-style-type: none"> <li>Click a box to check the option. The box fills to indicate it is checked.</li> </ul>
Close Button (x icon)		Used to clear a search field, or close a window or module	<ul style="list-style-type: none"> <li>Click the button to clear the search field, or close the window or module.</li> </ul>

## Master Editor

The Master Editor panel contains a number of global controls that affect the behavior of all Instruments in your Multi, as well as some common utility functions. To display the Master Editor panel, select the **Master** option in the Workspace menu.

The Master Editor panel contains the following features:

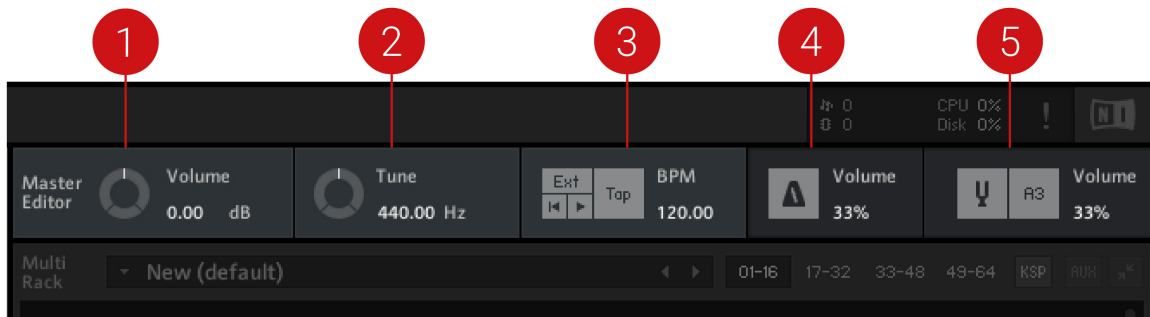

1. **Master Vol:** Adjusts the volume of all Output and Aux Channels. The default setting is 0.0 dB, which leaves the output levels unaffected.
2. **Master Tune:** Adjusts the master reference tuning from its default value of A4 = 440 Hz. This is especially useful in situations where Kontakt will be combined with the sound of orchestras, historical ensembles, or folk music, which frequently use different reference tunings.
3. **Master Tempo:** Displays the current global tempo in beats per minute, as well as sync options and song position controls.
  - **Ext:** In stand-alone mode, the **Ext** button allows you to sync Kontakt to an external MIDI clock. If running as a plug-in in your host program, Kontakt will use and follow your song tempo by default. Deactivate the **Ext** to specify the tempo manually.
  - **Tap:** The Tap button offers a more intuitive way to adjust the Master Editor tempo. Tap the button rhythmically in quarter note values and Kontakt will measure the time between taps, adjusting the tempo value accordingly. As a plug-in, the Tap button is active only when the **Extern Sync.** parameter is turned off.
  - **Play/Re-wind:** The play and re-wind buttons adjust Kontakt's internal song position. This is necessary for instruments that require song position information, like a drum machine.
  - **Tempo:** Located below the **BPM** label, this value affects the playback speed of sliced loops and all time-related controls that can be synchronized to the tempo. In stand-alone mode, adjust the Master Tempo by clicking the value and entering a new one, or by tapping a new tempo using the **Tap** button.
4. **Metronome:** Provides a simple metronome that can be switched on and off at any time by clicking the metronome icon. The value readout allows you to adjust the volume of the metronome click.
5. **Reference Tone:** Provides a reference tone that allows you to tune other instruments in accordance to Kontakt's current reference tuning.
  - **On/Off:** Activate the reference tone by clicking the tuning fork icon.
  - **Pitch:** Change the pitch of the reference tone by clicking and dragging on the note readout to the right of the tuning fork.
  - **Volume:** Adjust the volume of the reference tone by clicking and dragging the **Vol** readout, or double-clicking the field and entering a value.

## Side Pane (Classic view)

The Side pane in the Classic view allows you to quickly organize and navigate through any number of files that can be used in Kontakt. It displays a convenient overview of various aspects of the currently selected Instrument. The Side pane can be used to navigate through your file system to locate and load Kontakt Instruments, and also manage and browse the contents of your Libraries. It allows you to assign host and MIDI automation sources to Instrument parameters and to drag and drop items from the Side panel into the Rack.



To display the Side pane:

- ▶ Click the **Minimize** icon from the Control panel to expand the Rack.
- The Side pane will appear on the left side of the Rack.

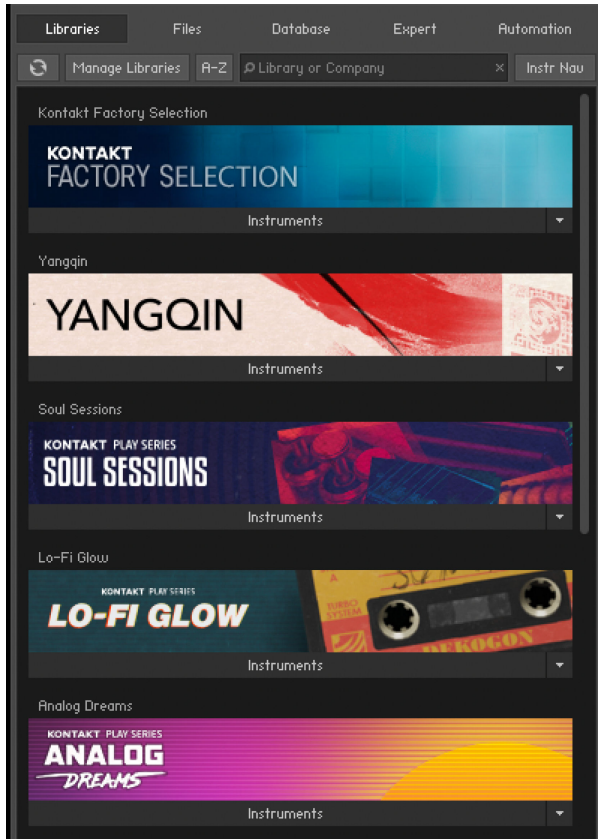

The Side pane

## Libraries Tab

The **Libraries** Tab provides direct access to all Kontakt libraries installed on your computer.

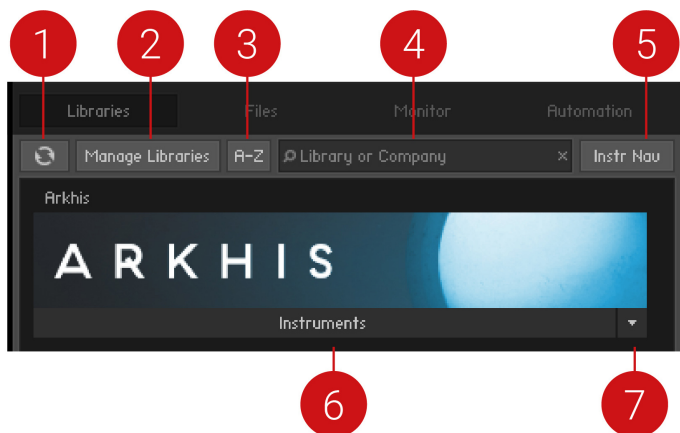

1. **Refresh:** Reloads the list of libraries.
2. **Manage Libraries:** Opens the Library tab in the Options dialog. There you can hide or show libraries, open Native Access to install new libraries, and manage existing installations. For more information, refer to [Libraries](#).

3. **A-Z:** Sorts the libraries alphabetically. When deactivated, the Library tab reverts to the previous custom sorting.
4. **Search field:** Allows you to enter a search string in order to find particular libraries within the Library tab.
5. **Instr Nav** (Instrument Navigation): Shows or hides the Instrument Navigator pane at the bottom of the Browser.
6. **Instruments:** Displays all Instruments included in the library.
7. **Function Menu:** Opens a drop-down menu with additional library options. For more information, refer to [Function Menu](#).

### Loading and Saving Instruments and Multis

- To load an Instrument or a Multi, click the **Instruments** or **Multis** button and navigate through the library structure like in the lower pane of the **Files** tab.
- When using Kontakt Player libraries, you can save your own Instruments and Multis to the original library or to any custom location. When saving your own variations to the original location of your library, these Instruments and Multis will also appear in the **Libraries** tab.

### Function Menu

The Function menu provides access to important resources like the library readme file and manuals, and maintenance tasks such as locating a library and hiding a library box. The Function menu is located at the bottom right of the Library box. Click the arrow to open the drop-down menu.

The Function menu contains the following options:

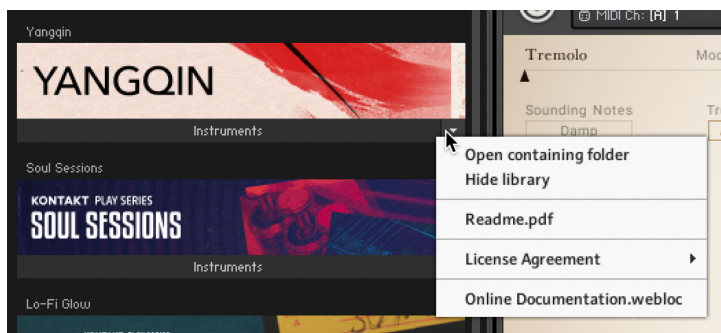

*The Function menu*

- **Open containing folder:** Opens the location of the library on your hard disk, in your operating system's file browser.
- **Hide library:** Removes the library from the Library tab. Note that this does not delete or uninstall the library. If you want the library to appear in the Libraries tab again, you can do this via the Libraries tab in the Options dialog. For more information, refer to [Libraries](#).
- **Readme.txt:** If the library folder contains a readme text file, it will be displayed here. Clicking this option will open the file.
- **License Agreement:** Contains a list of the licenses for the selected library.
- **Online Documentation:** Clicking this option will open the user manual.

### Library Activation

Libraries are activated through Native Access, but it is possible to quickly open Native Access to activate a specific library from the Kontakt Side pane.

1. After installing a library, open Kontakt.
  2. Locate the library in the **Libraries** tab of the Side pane.
  3. Click on the **Activate** button on the respective library and a log-in screen will open.
  4. Native Access will open and prompt you to enter a serial number for the library.
  5. Enter a serial number and click **Activate**.
- Your library will now be activated and ready to play.

## Files Tab

This section of the Side pane allows you to navigate your file system in a tree-based way, which will be immediately familiar if you're accustomed to your operating system's file browsers and selectors. It consists of two main panes and an audition toolbar at the bottom of the section. There is an optional third pane, the Instrument Navigator, which you can toggle via the **InstrNav** button just below the tabs. This pane is also available on the **Libraries** tab, refer to [Libraries Tab](#).

Click the horizontal splitter bars that separate the panes and drag them up or down in order to change the height of the respective panes.

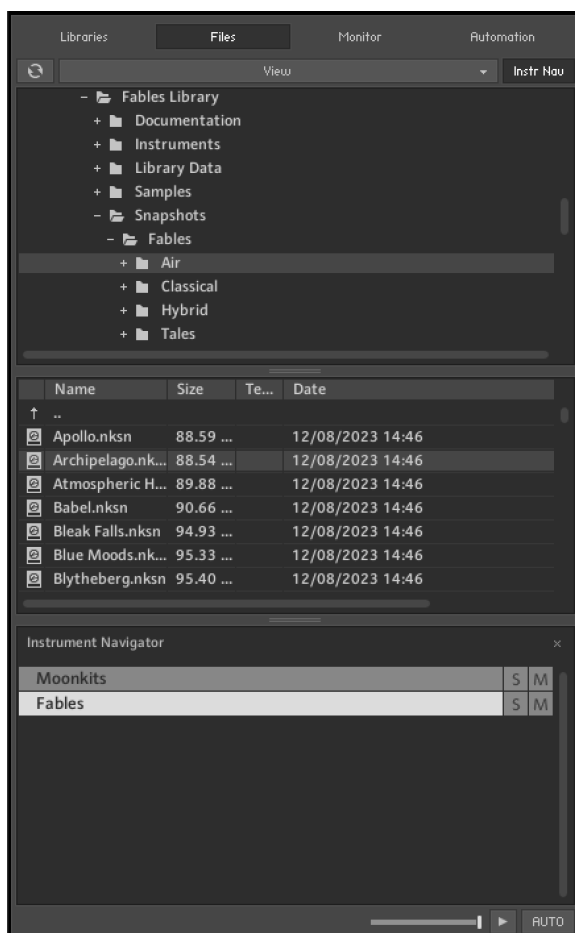

The Files tab of the Side pane provides a file system navigator

## Upper (Container) Pane

The upper pane shows all container objects on your computer in a tree structure. The term "container" encompasses all items that contain other objects, such as volumes (like hard disks, CD-ROMs or network places), folders and monolithic sampler files that serve as "virtual folders" (more on this later). A + icon next to an object indicates that there are further objects contained within, which are not currently being shown. Display those by clicking the + icon. Conversely, clicking the - icon next to an object hides all its contents from the tree view.

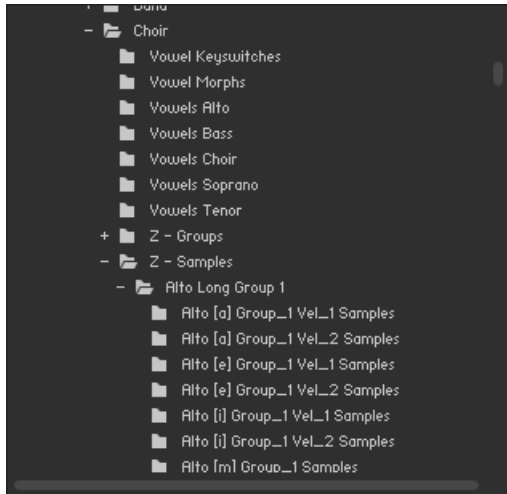

The upper pane of the File Browser displays a navigable tree structure of your file system.

## Middle (Objects) Pane

Whenever a container object that you have selected in the upper pane contains items which can be used in Kontakt, these will show up in the middle pane. In contrast to the multi-dimensional tree structure of the upper pane, this list is always flat and does not span multiple folders. In addition to relevant files, folders (if any) will also show up in this list and can be navigated to via double-clicking. The first item of the list will usually be the parent directory, indicated with an arrow icon. This means you don't need to use the upper pane to navigate through folders, although it's usually faster and more convenient.

Name	Size	Te...
↑ ..		
Alto [a].nki	35.38 kB	
Alto [e].nki	34.95 kB	
Alto [i].nki	35.09 kB	
Alto [m].nki	30.63 kB	
Alto [o].nki	30.70 kB	
Alto [u].nki	30.65 kB	

The middle pane of the File Browser, displaying a number of Samples, their file sizes, native tempos, and modification dates.

Information on the displayed items is spread across four columns; in addition to the file name, size and modification date, there's also a tempo column that indicates the native tempo of sliced loops. You can change the width of these columns by clicking and dragging the separator bars between their labels. Clicking on a column label will change the sort order of the list according to the respective value and clicking on the same label again will reverse the ordering direction.

Once you have found one or more items that you want to use in Kontakt, there are several ways to load them:

- Double-click a Multi file (.nkm) or drag it from the Side pane into the Rack to load it; Kontakt will ask you whether you want to replace your current Multi or merge the one you've selected with the existing Multi.
- Double-click an Instrument file (.nki) or drag it from the Side pane onto a free space in the Rack to add it to your current Multi. Kontakt will assign a MIDI channel according to the **MIDI channel assignment for loaded patches** setting in the Options dialog. This also works with multiple Instruments.
- Drag an Instrument onto an existing Instrument Header in your Rack to make it replace the respective Instrument. Kontakt will keep the MIDI channel setting of the previous Instrument.
- Double-click a Sample (i.e. an audio file) or drag it onto a free space in the Rack to create a new Instrument (based on your default Instrument) that contains a Zone with this Sample spread across the whole keyboard range. If you do this with multiple Samples, Kontakt will still only create one instrument, but with a corresponding number of adjacent Zones. Note that this does not work with 8-bit Samples, as Groups created in this way will be set to DFD mode by default, which does not support 8-bit data.
- Click and drag a Sample into the Mapping Editor of an existing Instrument to create a Zone and place it on the key or key range you're pointing at. While dragging, move the mouse pointer up and down in the Mapping Editor to enlarge or shrink the target key range. This also works with multiple Samples, in which case Kontakt will create a number of adjacent Zones. If you want to create multiple Zones above each other (thus combining a number of Samples into a velocity switch that's placed on a single key), move the mouse pointer all the way down to the keyboard.
- There are two ways to select multiple items in the object pane: contiguous ranges of items in the list can be selected by clicking the first item and then, while holding your [Shift] key, the last one in the range. Non-adjacent items can be selected with [Ctrl]-click, or [Cmd]-click on Mac OS.



The sort order of the Side pane's object pane determines in which order multiple Samples will be used in Kontakt. For instance, if you're planning to create a velocity switch from a number of Samples, but realize after placement that the velocity assignment ended up being upside down, just reverse the list order in the Side pane and try it again.

## Instrument Navigator Pane

The Instrument Navigator shows a list of all Instruments in the Rack, which is updated at all times. It is divided into 4 pages of up to 16 Instruments each, and displays the Instrument names along with **M** (mute) and **S** (solo) indicators. It provides a good way to keep the bigger overview when you're editing an Instrument, when the Rack does not convey any information about Instruments other than the currently edited one.

The Instrument Navigator list will keep in sync with the page and Instrument selection in the Rack and vice versa. To switch to one of the four Instrument pages, you can either use the page buttons in the Rack header (if it's in Multi Instrument mode), or click the page numbers at the top of the Instrument Navigator list. Similarly, you can select an Instrument by clicking on either its header in the Rack, or its entry in the Instrument Navigator pane. If an Instrument that you select is not currently visible in the Instrument Navigator list, it will automatically scroll to its list position. Double-clicking an Instrument in the Instrument Navigator list will open it for editing in the Rack.

- To display the Instrument Navigator pane, click on the **InstrNav** button at the top of the Side pane.

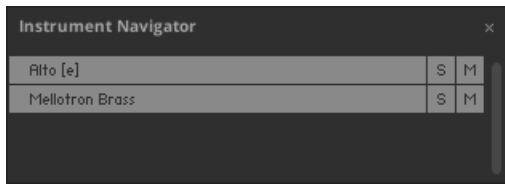

The Instrument Navigator pane, displaying a number of loaded Instruments in the Multi.



The Instrument Navigator is not strictly specific to the **Files** tab, but rather a utility window that's available in various tabs in the Side pane. It's explained here for sake of consistency, and referenced briefly in sections about other places where it's available.

### Audition Strip

The Audition Strip allows you to listen to audio files prior to loading them. This feature works with audio files and sliced loops that you select in the lower section of the Side pane. Note that when auditioning sliced loops, they will not be played in their native tempo (which is being displayed in the Side pane list), but in the current tempo of your host or, if you're running Kontakt in stand-alone mode, the tempo that's set in the Master Editor.

The Audition Strip contains the following controls:



The Audition Strip allows you to play any Sample that you select in the Side pane.

- **Volume slider:** This slider adjusts the sample playback level.
- **Play button:** This button plays the selected sample once or, if a sample is currently being auditioned, stops the playback.
- **Auto button:** When activated, Kontakt will automatically play a sample once when you click it.

### Refresh Button

Just below the Side pane tabs, you will find a series of function buttons and drop-down menus that are specific to the currently visible tab. On the **Files** tab, this row starts on the left side with a Refresh button, depicted by a circled arrow.



Whenever the File Browser has not yet picked up changes that recently occurred in your file system, such as newly installed or removed sample libraries, you can force an update of the file display by clicking this button.

### The View Menu

The View menu in the Files tab contains options and functions that alter the way in which information will be shown in the File Browser panes.

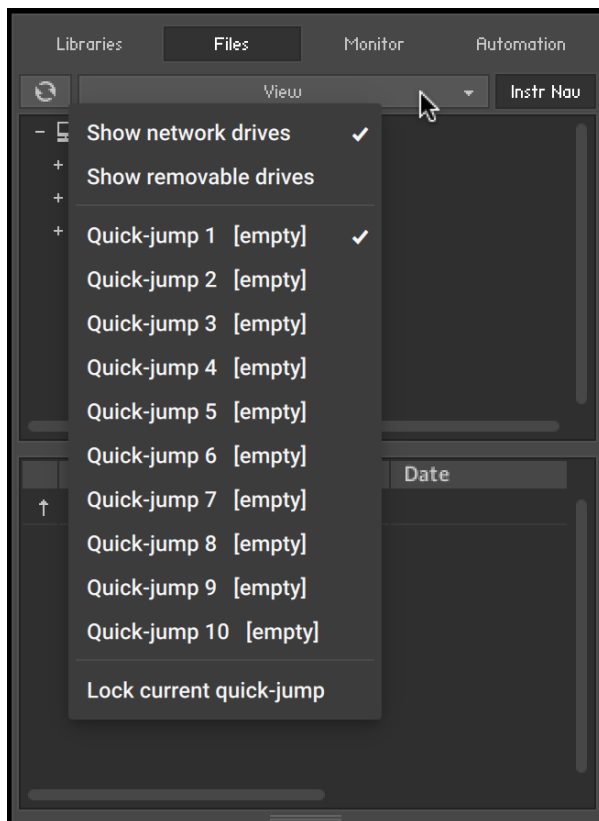

The view menu of the File Browser contains options that determine which items will be shown.

The first two items in this menu, labeled **Show network drives**, and **Show removable drives**, are toggle options; selecting them will switch them on, indicated with a small diamond next to their label. With these, you can adjust whether the File Browser should include mounted network volumes, and removable drives.

Below the options, you'll find multiple slots labeled **Quick-jump** and numbered **1** to **10**. Quick-jumps are location memories that you can use to conveniently access a number of frequently-visited places in your file system without the need to navigate there using the container pane each time. The handling is simple: any location you navigate to in the File Browser gets immediately saved to the currently selected Quick-jump entry. Once you switch to another Quick-jump location, the previously selected one will keep its value. Switching back to it will bring you to the saved location, but watch out — if you navigate any further now, the Quick-jump memory will be changed accordingly. If you don't want this, activate the **Lock current quick-jump** option at the bottom of the **View** menu to freeze the saved location. Instead of using the pull-down menu each time, you can also use [Ctrl] + [F1] through [Ctrl] + [F10] (Windows) or [Alt]-[F1] through [Alt]-[F10] (Mac) to access the respective Quick-jump locations via your keyboard.

## Monitor Tab

When editing a complex Instrument with various Groups and Zones, it's easy to get lost in KONNTAKT's editing facilities. The **Monitor** tab counteracts this by providing a useful overview of various aspects of your currently edited Instrument. Similar in nature to the Instrument Navigator pane, it shows a continually updated and searchable list of all Groups and Zones in your Instrument. It allows you to quickly include and exclude Groups for editing, and provides a context sensitive parameter view that shows the values of the parameter you touched last across all Groups.

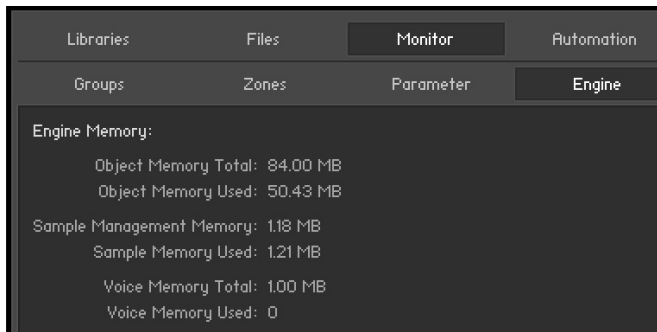

Monitor tab, displaying all Parameters of the Gongs Instrument

At the top, you'll notice a tool bar with five buttons, the first four of which will switch the Monitor view into the respective display mode:

## Groups

This view provides a list of all Groups in your Instrument. It will only work in Instrument Edit mode. The leftmost column indicates whether a Group is marked for editing — it corresponds to the checkboxes next to the Group names in the Group Editor — and can be clicked on to toggle the edit status of the respective Group.



The Group selection only affects commands that can be found in the "Edit" menu of the Group Editor, and is thus different from the editing checkbox, which is being used for changing parameters across multiple Groups.

At the right side of the list, the Group indexes are displayed as a quick reference for KSP script editing, as well as the number of Zones included. Groups can be selected by clicking on their names; multiple selections work in the same way as they do in the File Browser, i.e. [Shift]-clicking below or above a selected Group will select a range, a [Ctrl]+click ([Cmd]+click on Mac OS X) will add Groups to the active selection; [Alt]+click will select all currently visible Groups for editing.

You can rename Groups by double-clicking on their name and entering a new one.

Right-clicking on a Group will open a context menu with various Group-related actions; this is identical to the Edit menu of the Group Editor.



	Alicias Keys Groups	Index	Zones	
<input checked="" type="checkbox"/>	PU sus A0-E6	0	816	
<input type="checkbox"/>	PU sus F6-C8	1	220	
<input type="checkbox"/>	PD sus A0-E6	2	748	
<input type="checkbox"/>	PD sus			
<input type="checkbox"/>	PU sus			
<input type="checkbox"/>	PU sus			
<input type="checkbox"/>	PD sus			
<input type="checkbox"/>	PD sus			
<input type="checkbox"/>	PU sus			
<input type="checkbox"/>	PU sus			
<input type="checkbox"/>	PD sus			
<input type="checkbox"/>	PD sus			
<input type="checkbox"/>	PU sus			
<input type="checkbox"/>	PU sus			
<input type="checkbox"/>	PD sus			
<input type="checkbox"/>	PD sus			
<input type="checkbox"/>	release			
<input type="checkbox"/>	FX rele:			
<input type="checkbox"/>	FX rele:			
<input type="checkbox"/>	FX PD release A0-C8	19	88	

*The Group context menu*

You can toggle a Quick-Search function by clicking on the button with the magnifying glass symbol to the right side of the list header. This will show a text input box above the list; while it is visible, the list will only show Groups whose names contain whatever you enter into this box.

You can hide (and, in consequence, deactivate) the Quick-Search feature by clicking the "X" button on the right side of the search bar.

## Zones

This view displays a list of all Zones that are contained in your Instrument across all Groups. Otherwise, it works exactly like the Groups view, and includes the Quick-Search feature as well.

Each row displays from left to right: The Zone, its Index, its ID, and finally the Group the Zone belongs to.

Double-clicking a Zone will open it in the Wave Editor.

## Parameter

When you switch to this view and touch any knob, the Monitor pane will show the values of the respective parameter across all Groups in your currently edited Instrument, or, if you're not in Instrument Edit mode, across all Instruments in your Multi. This makes for a convenient way to compare settings across Groups. You can also change parameter values directly within the list by clicking on their value and moving the mouse vertically, just like you would do on the respective knob.

Groups	Zones	Parameter	Engine
Gongs Freq 1 Slot2			
Large Gong Open			189.1 Hz
Large Gong Swell Long			NA
Large Gong Stick			250.0 Hz
Large Gong Swell Short			250.0 Hz

Monitor tab, displaying the values of EQ frequency parameters across multiple Groups.

Of course, parameters will only appear next to Groups that actually contain the edited parameter as well. For instance, if you're adjusting the Grain parameter of the Source Module – which is unique to the Time Machine mode – all Groups that are not currently in Time Machine mode, and therefore don't know this parameter, will be indicated with **NA** in the Value column.

## Engine

This sub-tab displays an overview of various system resources, such as detailed memory and CPU usage statistics. The information provided on this page is mainly intended for power users; when you have a problem and get in contact with the Native Instruments support, they might ask you for specific values from this page.

Libraries	Files	Monitor	Automation
Groups	Zones	Parameter	Engine
<p><b>Engine Memory:</b></p> <ul style="list-style-type: none"> <li>Object Memory Total: 84.00 MB</li> <li>Object Memory Used: 50.43 MB</li> <li>Sample Management Memory: 1.18 MB</li> <li>Sample Memory Used: 1.21 MB</li> <li>Voice Memory Total: 1.00 MB</li> <li>Voice Memory Used: 0</li> <li>DFD Voice Memory: 0</li> <li>TM Pro Voice Memory: 0</li> </ul> <p><b>Event Queues:</b></p> <ul style="list-style-type: none"> <li>Note Events used: 0 / 8192</li> <li>Controller Events used: 0 / 4096</li> </ul> <p><b>Miscellaneous:</b></p> <ul style="list-style-type: none"> <li>Additional Latency: 5.333 ms</li> <li>CPU Load (12 cores used): 0 %</li> <li>DFD Usage: 0 %</li> <li>Process Buffer: 512 samples</li> </ul> <p>Restart Engine</p> <p>CPU Profiling Mode</p>			

The Engine page provides an overview of the current status of Kontakt's audio engine.

The **Restart Engine** button allows you to force a reinitialization of Kontakt's audio engine in case of CPU overruns.

If you're using Kontakt as a plug-in, there will be another button below labeled Offline (Bounce) Mode. This is intended for hosts that don't correctly advertise this mode to their plug-ins when bouncing or freezing tracks. You can check if your host behaves correctly in this regard by observing the state of the button when bouncing or freezing; if it turns orange, Kontakt receives the bounce signal from the sequencer. If it doesn't and you experience crackles or drop-outs, you can activate this button manually before bouncing or freezing.

**CPU Profiling Mode:** Switch to CPU Profiling mode in order to identify which parts of your Instruments are currently consuming the largest share of processing power. Percentages are shown in the instrument name as well as in the Source module in Edit mode and in the top parts of all effects in the effect chains.



Use the bottom part of the effect icons to switch to different effect slots for editing while in CPU Profiling mode.

- **Instrument name:** observe the Rack to identify most consuming Instruments first, then switch to Edit mode.
- **Source module:** switch to a different HQI setting if CPU usage is too high. If you are using Time Machine Pro, consider downgrading to the lighter Time Machine engines.
- **Group Inserts:** Move memory-intensive effects without attached modulators to the Instrument or Bus Inserts instead. Remember group effects are calculated per voice!
- **Instrument Inserts / Bus Inserts / Sends:** Move memory-intensive effects to the **Outputs** section, inserts into the regular output channel, sends into the Aux channels.

Just like the File Browser, the Monitor pane optionally provides an Instrument Navigator list. This can be shown and hidden with the rightmost button of the Monitor toolbar. For an in-depth explanation of what this pane does, refer to [Instrument Navigator Pane](#).

## Automation Tab

When you need to control a parameter of an Instrument from outside Kontakt, for example, using a sequencer's automation system or MIDI controller data generated by an external fader box, you can easily pick and assign the appropriate automation source from the **Automation** tab of the Side pane.

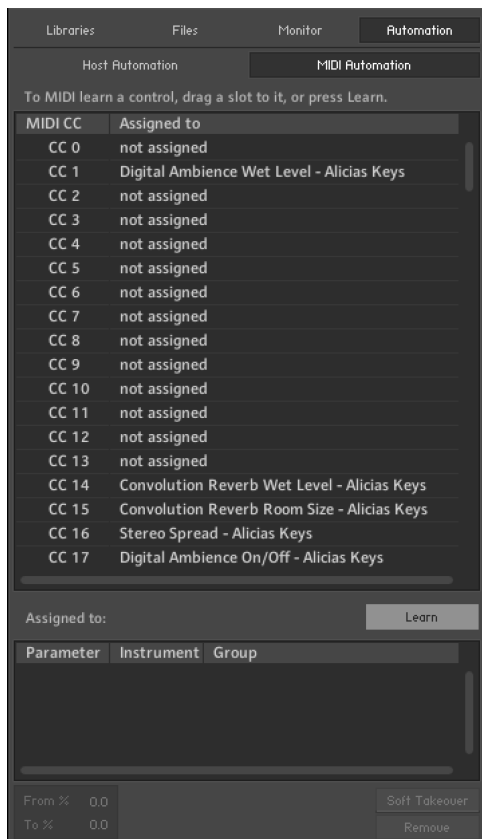

The MIDI Automation page displays a list of assignable MIDI controllers at the top, and details of the selected assignment at its bottom.

At the top of the **Automation** tab, two buttons allow you to switch between the list of automation sources that are provided by your host and MIDI controllers. Assigning a source to a parameter works the same way in both lists, so the described concepts and process for working with MIDI automation can be applied to the host automation workflow.

Assign automation by selecting a source from the list and dragging it onto a knob whose parameter you want to automate. If you want to assign a fader of a keyboard or a MIDI controller, but you are unsure which controller number is correct, just move the fader when the MIDI automation list is visible and Kontakt will flash a red dot next to the respective list entry when it receives any MIDI controller data. This allows you to quickly spot and assign the appropriate controller.

Another way to assign a source to a parameter is via the **Learn** button. Press it once to enter **Learn Single** mode. After moving a modulation source on your MIDI controller, such as a knob or slider, click on a parameter of the instrument to assign it. Learn Single mode will deactivate automatically and the control will become usable immediately.

To do multiple MIDI assignments successively, press the **Learn** button twice to enter **Learn Multiple** mode. This allows repeating the above steps of turning a control and clicking on a parameter indefinitely. Click the **Learn Multiple** button to exit this mode and start using the controls.



Multiple parameters can be assigned to the same automation source. This allows you to control multiple aspects of your Instrument with a single controller, such as increasing the brightness of an Instrument in combination with the loudness. Also note that modulation wheels usually send MIDI Controller #1, while volume controls send #7.

You can edit assignments and their parameters by selecting them in the list. If the selected item is assigned to one or more parameters, these will show up in the list below. At the bottom of the pane, you can adjust some parameters of the assignment that is selected in the lower list:

- **From % / To %:** Adjusts the range of the assigned parameter. By default, automation controllers are mapped in a way that makes them cover the whole available range of the parameter. By changing these values, you can alter the scaling of the assignment so that the automation values are mapped to a limited range of the assigned parameter. This allows you to automate the section of the parameter's range with finer resolution.
- **Soft Takeover:** Avoids sudden parameter jumps that can happen if received automation data is different from the current value of the assigned parameter. If you activate this button, the assigned parameter will not be changed until an automation value is received that matches the parameter's current value. A typical example would be the assignment of an external fader to a filter's cutoff parameter; if the filter cutoff is currently set to 50% and you slowly move the fader upwards, Kontakt will softly pick it up as soon as it reaches its mid-point.
- **Remove:** Deletes the automation assignment selected in the lower list.

### Assigning MIDI Controllers via the Learn button

To assign MIDI controllers to controls via the Learn button:

1. Make sure at least one instrument is loaded and set to the MIDI port and channel of your hardware controller.
2. Click the **Automation** tab in the Side pane.
3. Select the **MIDI Automation** sub-tab.
4. Click the **Learn** button once to assign a single MIDI control. Click it twice to assign many MIDI controls. The button will show either **Learn Single** or **Learn Multiple**.
5. Move the control on your MIDI device that you want to assign.
6. Click the control in the GUI of the instrument that you want to assign.
7. When assigning multiple controls using **Learn Multiple**, repeat step 5 and 6 until all controls have been assigned. Afterwards click the **Learn** button again to stop assigning controls and start using them.

→ The MIDI Controller is assigned to the parameter.

### Assigning MIDI Controllers in the Side Pane

If you are unable to assign MIDI controllers as described in [MIDI Learn](#), there is an alternative way:

1. Make sure at least one instrument is loaded and set to the MIDI port and channel of your hardware controller.
2. Click the **Automation** tab in the Side pane.
3. Select the **MIDI Automation** sub-tab.
4. Turn a knob or move a slider on your hardware controller.
5. In the Side pane, you should see a flash next to the CC# that is used by your external controller; in addition, the MIDI symbol in the Instrument header should flash.

6. If this does not work, open the **Options** dialog.
7. Select the **MIDI** tab.
8. Select **Inputs**. Check if your MIDI hardware is selected as input for the same port you have assigned the instrument in question to.
9. If the MIDI input is setup correctly, drag and drop the MIDI CC# you wish to use onto the parameter you wish to control.

→ The MIDI Controller is assigned to the parameter.

MIDI CC	assigned to
CC 0	not assigned
CC 1	not assigned
CC 2	not assigned

*MIDI controller reception in Kontakt*

## Removing MIDI Controller Assignments

To remove an assignment made to a specific controller:

1. Click the **Automation** tab in the Side pane.
2. Select the **MIDI Automation** sub-tab.
3. Find the MIDI control whose assignment you wish to remove, either by searching, or by moving the control and seeing which number in the list is highlighted with the lightning bolt symbol.
4. Select the control in the list and click the **Remove** button.

→ The MIDI controller assignment is removed.

## Quick-Load Catalog

The Quick-Load catalog is an organizational tool that helps you manage your Instruments, Banks, and Multis. It is similar to the File Browser in that it provides access to a hierarchical directory structure. However, the Quick-Load catalog allows you to freely define its structure without consideration for file paths, library relationships, or formats. This acts as a type of "virtual file system", that exists in parallel to the actual file system on your hard disks. Use the Quick-Load catalog to freely organize and index your files, without copying or moving them to different locations.

The Quick-Load Browser appears below the Rack when you right-click inside the empty Rack space below the Instrument Headers. Resize this pane by clicking and dragging the bar that separates it from the Rack. When the Quick-Load Browser is visible, it will hide the on-screen keyboard.

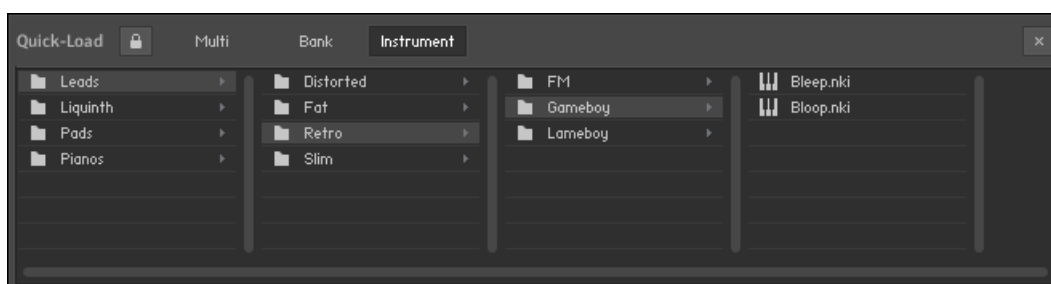

*The Quick-Load Browser, displaying an exemplary directory structure.*

- **Lock:** Protects the Quick-Load file structure from being altered when dragging files and folders.

- **Catalog Type:** Switches between the catalogs of Multis, Banks, and Instruments, respectively. The contents of these catalogs are in no way related to each other, so independent directory structures can be created for each of the three catalog types.
- **Close** (x icon): Closes the Quick-Load Browser. Right-click inside the empty region of the Rack to hide the Browser again. When the Quick-Load Browser is visible, the on-screen keyboard is hidden.
- **Directory Area:** Displays multiple layers of a directory tree in a horizontal arrangement of columns. When a subdirectory in one column is selected, its contents are displayed in the column to the right, with each additional column opening another sub-layer of the directory tree.

## Building a Catalog

In order to organize any larger number of objects, you should begin by devising a directory structure that's consistent with your approach to locating Instruments, Banks and Multis. The criteria you choose for this is entirely up to you; for instance, you could categorize your objects by their instrument types, music genres or libraries. You could also combine these and sort your collection by a coarse type category on the root level, then by the respective libraries on the levels below that. Of course, it's also possible to mix categories on the same level – since no actual files will be touched when managing your collection via the Quick-Load Browser, you can easily put the same object into more than one directory.



In case you'd like to keep your favorite Instruments in direct access at all times, you can put these – in parallel to your normal categorization in the Quick-Load Browser – into a “favorites” directory. As contents are always sorted alphabetically, though, this directory will most likely appear amidst all others. To circumvent this, just prepend its name with a special character, such as an asterisk (\*); that way, it will always appear at the top of the list.

To create a new directory:

1. Right-click into the empty list inside the leftmost column
2. Choose the command **Add New Folder** from the context menu.
3. A new directory entry will appear. Give it a meaningful name
4. Repeat these steps for every directory that you want to create on the root level.

To create subdirectories that extend the directory structure with deeper levels:

1. Select one of the new entries and create more subdirectories within the column next to it as described. That way, you can build a hierarchical directory structure step by step. Of course, you can also extend a Quick-Load catalog that has already been populated with content at any time.
2. To rename a directory entry, double-click it or, alternatively, right-click and choose **Rename Folder** from the context menu.

To fill your directories with content:

1. Drag one or more files from the Browser into the column of the directory in which you'd like to put them. It doesn't matter if these originate from the Files or Libraries tabs; you can even drag Kontakt-relevant files directly from your operating system's file navigator into the Quick-Load Browser.

- While you're dragging your objects (with mouse button held down), you can still navigate through the Quick-Load catalog in order to locate a specific directory. Just move your mouse pointer across the directory entries that you'd like to switch to; the columns to the right of the current one will adapt their contents accordingly.

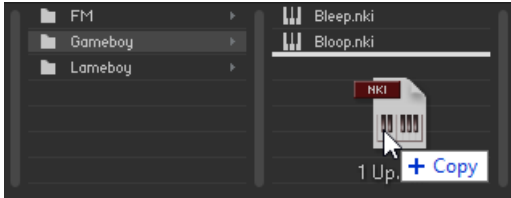

In order to remove a directory, a subdirectory, or an object from a directory of the catalog:

- ▶ Right-click its entry and select the **Delete from Quick Load** command from the context menu. Of course, no actual files will be deleted in this process.

## Loading Objects from the Catalog

During your work with Kontakt, the Quick-Load catalog is just a mouse click away at all times, and you can use it at any time to quickly locate and load Instruments, Banks or entire Multis. For this, you can use the Quick-Load Browser itself or, alternatively, one of the Quick-Load menus that replicate the structure of your catalogs as hierarchical drop-down menus. We'll describe both methods in this section.

To open the Quick-Load Browser, right-click the empty space inside the Rack. First, use the type switches at the top to select the kind of objects that you'd like to access. Following the instructions in the previous section, you can now navigate the respective catalog, going from left to right, until you've found an entry that you'd like to load. If the object is an Instrument or a Bank, you can add it to your Multi either by double-clicking on it, by dragging it into the empty space inside the Rack, or by right-clicking on its entry and choosing **Load** from the context menu. Alternatively, you can replace an existing object in your Multi by dragging its replacement onto the respective header in the Rack or choosing its position from the submenu **Load Into Slot**, which you can find in the context menu. Loading a Multi works in the same way, but in that case, you can only choose between replacing or combining your current Multi with the new one.

An alternate method of accessing your catalogs is offered by way of the Quick-Load menus, which you can find in different spots of the user interface, depending on whether you'd like to add a new object to your Multi or replace an existing one. In the former case, click the button labeled **Files** in the Header and open the submenu **New Instrument from List** or **New Instrument Bank from List**. It contains the entire structure of the respective catalog as a list of menu entries and submenus, which you can traverse in the usual way.

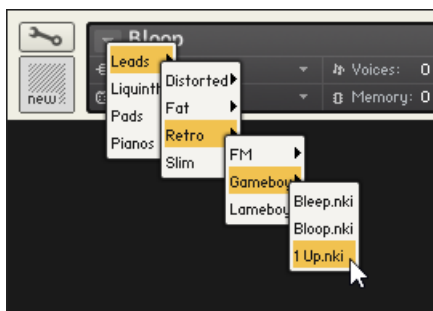

*Replacing an Instrument using the Quick-Load menu*



The same menus appear when you click the small down arrows inside the name fields of the Instrument, Bank, and Rack headers. In that case, the respective Instrument, Bank, or the entire Multi will be replaced with the object that you select from the menu.

## Outputs Section

Kontakt's Outputs section provides a routing and mixing environment in the style of a traditional mixing console. The output signals from all Instruments in the Rack are sent to this section, then routed to the physical outputs of an audio interface or host software. Use the Outputs section to create, delete, rename, and configure Output Channels, which act as mono, stereo, or multichannel signal routing destinations for your Instruments. Rename and configure Aux Channels, adjust the Output and Aux volumes, and monitor your output levels.

To display the Outputs section:

► Select the **Outputs** option in the Workspace menu.

→ The Outputs panel will appear in the lower half of the Rack space.

The Outputs section contains the following controls:

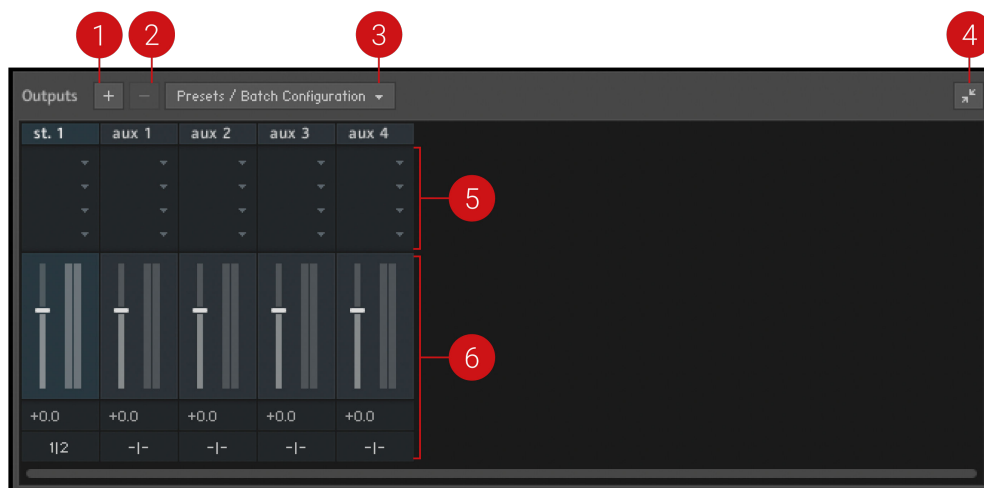

*The Outputs section, displaying a stereo Output Channel strip and the four Aux Channel strips, left to right.*

- 1. Add Channels (+ icon):** Opens a dialog to create and configure new output channels. For more information, refer to [Working with Output Channels](#).
- 2. Delete Channel (- icon):** Removes the currently selected channel from the Outputs section. To select a channel, click its border.
- 3. Presets/Batch Configuration:** Opens a dropdown menu containing options for saving, resetting, or reconfiguring the Outputs section.
- 4. Show Inserts:** Toggles the Insert slots display. If deactivated, the Insert slots are hidden and the height of the panel is reduced in order to save screen space.
- 5. Channel Insert Slots:** Contains slots for signal processing modules, which can be inserted onto a channel to process its signal. The Insert slots are only visible if the Outputs panel is at full size. For more information, refer to [Working with Signal Processors](#).
- 6. Channel Strips:** Displays the controls for the Output Channel strips, followed by four Aux Channel strips. For more information, refer to [Channel Strips](#).

## Channel Strips

Output Channels and Aux Channels contain the following identical controls:

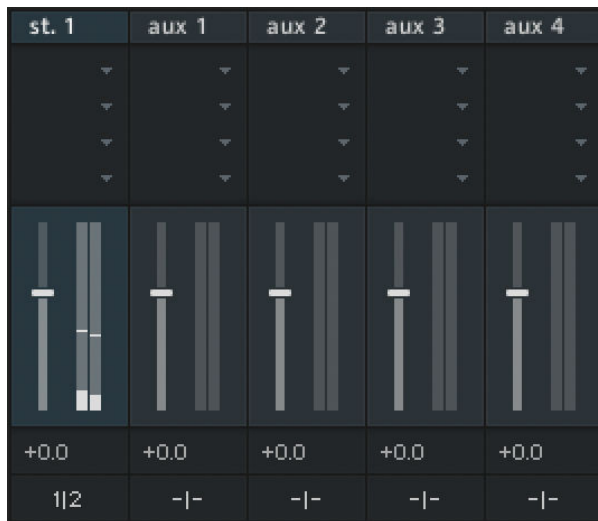

- **Channel Name:** This name will be used throughout Kontakt whenever it refers to this channel. Change the name by clicking the text field and entering a new name.
- **Channel Insert Slots:** These slots host signal processing modules, which can be inserted onto a channel to process its signal. The Insert slots are only visible if the Outputs panel is at full size. For more information, refer to [Working with Signal Processors](#).
- **Channel Fader** and **Level Meter:** The vertical fader adjusts the output gain of its respective channel. The corresponding bar meter provides visual feedback on the signal level.
- **Channel Configuration:** This button opens a dialog window with options to configure the channel's name, the number of audio channels it carries, and its physical output assignment.

## Working with Output Channels

In Kontakt, the output signal of each Instrument in the Multi can be routed to any Output Channel that is defined in the Outputs section. Each of these Output Channels can be configured to carry between 1 and 16 audio channels. When a note is played, the respective Instrument's output signal arrives at the assigned Output Channel, then passes through any channel Inserts, the volume fader, and is finally sent to the the physical output defined in the channel's Configuration dialog. The bar-graph display next to the channel fader indicates the signal level at the output.

**i** The Master Volume control, located in the Master Editor, will affect the levels of all Output and Aux Channels in the Outputs section. For more information, refer to [Master Editor](#).

## Output Configuration

The Output configuration must contain at least one channel. New Output Channels are configured for stereo signals by default, and can be changed in the channel's configuration dialog. New Instruments will always be assigned to the leftmost channel in the Outputs section by default.

The Channel Configuration dialog contains the following elements:

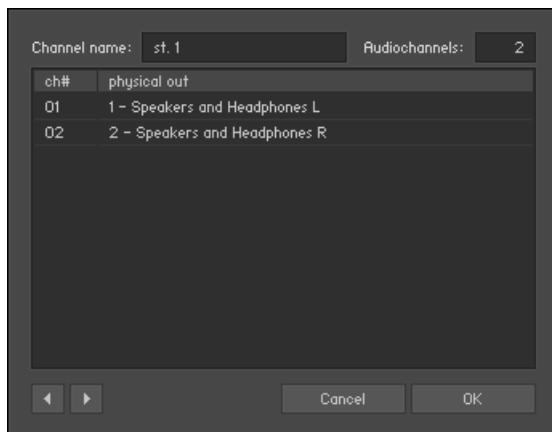

*The Channel Configuration dialog*

- **Channel name:** Displays the name of the channel. Rename a channel by clicking on the text field and entering a name.
- **Audiochannels:** Adjusts the number of audio channels this channel will carry, up to a maximum of 16. To change the number, click the field and drag your mouse up or down, or double-click the value field and enter a number (1-16).
- **Output Map:** Displays all audio channels of this Output Channel along with their assigned physical destinations, both output jacks on your audio interface or virtual connections to your host. To change a physical output assignment, click its name and choose a new output from the drop-down menu.
- **Previous/Next** (arrow icons): Moves to the settings of the previous or next channel of the Outputs section, allowing you to quickly adjust the output configuration for all channels at once.

## Working with Aux Channels

The four Aux Channels in Kontakt offer identical controls to the Output Channels, but receive their signal from other places. While each Instrument routes its output signal to only one Output Channel, you can additionally send this signal to one or multiple Aux Channels, at adjustable levels. This allows you to easily create sub-mixes.

You can also use the Aux Channels as routing destinations for all Send Effects that appear in your Instruments. This allows you to “tap” wet effect signals in order to process them independently from the dry signals. How this kind of routing works is explained in [Using filters and effects in Classic view](#).

Aside from this difference, Aux Channels work in exactly the same way as Output Channels; each has its own channel strip in the Outputs section, can contain up to four insert signal processors, and can be routed to specific physical outputs. In addition, the levels of all Aux Channels can be adjusted globally with the Master Volume control located in the Master Editor.

## Working with Signal Processors

Kontakt provides a range of signal processors that can be added as inserts and sends in the Outputs section. Inserts are provided within the Output Channel strips, while the Aux Channels can be used to send effects across Instruments. Each Channel has four slots, which can be loaded with different signal processors for varying uses.

To add a signal processor to a slot:

1. Click the menu button (arrow icon) on a slot to open the Effects menu.

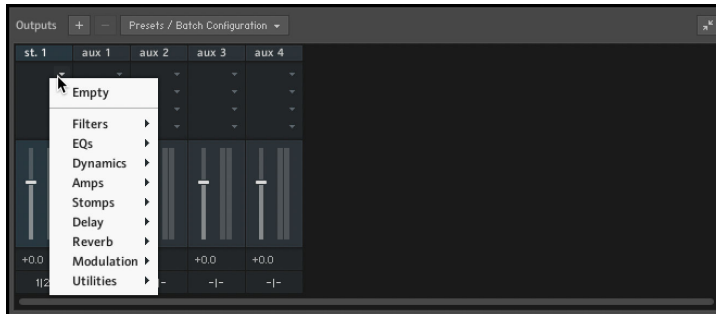

2. Select from the nine categories, then select a module to load it onto the slot.

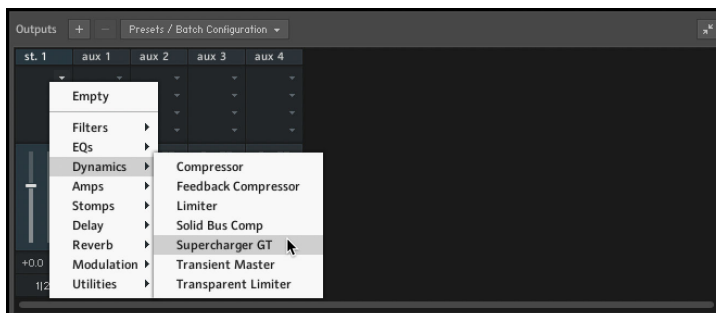

3. Click the module name to access its parameter controls and editing options.

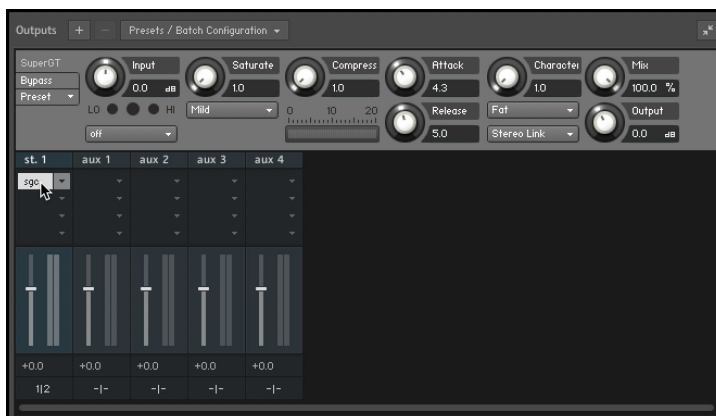

For an overview of the signal processors, refer to the [Kontakt User Manual](#).

## Outputs in Host Mode

When using Kontakt in stand-alone mode, physical outputs are also assigned within the Channel Configuration dialog. The drop-down menu contains all outputs that are provided by the audio interface selected in the **Audio** tab of the **Options** dialog. When using Kontakt as a plug-in in audio hosts, there are more details to consider as each host handles plug-ins with multiple outputs differently.

The maximum number of (mono) audio channels that can be assigned in host mode is limited to 64 for the VST/VST3 version of Kontakt, and 16 for the AU and AAX versions.

Changes to output configuration cannot be made during operation. In consequence, when making changes in the Outputs section, a dialog will appear asking to save and reload the song. First, go to the **Presets/Batch Configuration** menu and select the appropriate option from the **Save current output section state as default for** sub-menu.

Another caveat relates to the fact that the output configuration of each Kontakt instance will be saved along with your song; this can result in the rather unfortunate case of several loaded Kontakt instances with different output configurations. This can confuse your host and lead to unexpected behavior, so when you're working with Kontakt as a plug-in, it is recommended that you make all output configuration changes as default for that specific plug-in type.

## Group Editor

Groups are perhaps the most prominent entity of a Kontakt Instrument. In addition to providing a way to combine and use a common signal path for any number of Zones in your Instrument, Groups allow you to define conditions on which Zones will be played, adjust how the voice allocation for the contained Zones will be handled, and provide a selection mechanism that lets you change parameters in unison across groups. What's more, you can export and import Groups to and from your hard disk, which is the most convenient way to copy parts of one Instrument to another.

Generally, when you create your own Instruments, you should find a consistent way to distribute your Zones into Groups. This can be a common aspect of the Zones that serves as an attribute for dividing them into categories; for instance, if you create a chromatically sampled Instrument with four velocity layers, you could distribute the Zones on each layer across four Groups named "vel 0-31", "vel 32-63", "vel 64-95" and "vel 96-127". This way, should you decide later that the highest velocity layer needs some additional "sparkle" to cut through your mix, you can simply select the respective Group for editing and add a EQ with a treble boost to its Group Insert Effects chain.

As another example, if you want to add release samples, you'll need to move them into a separate Group, as the required Release Trigger parameter always acts upon a whole Group.

Once you've gotten the hang of how the Group concept works, you'll need a convenient way to create, delete, access, name, and manage the Groups in your Instrument; this functionality is provided by the Group Editor.

► When you're in Instrument Edit mode, click the button labeled **GroupEditor** at the top of the Instrument Edit view

→ The Group Editor will appear in the Rack.

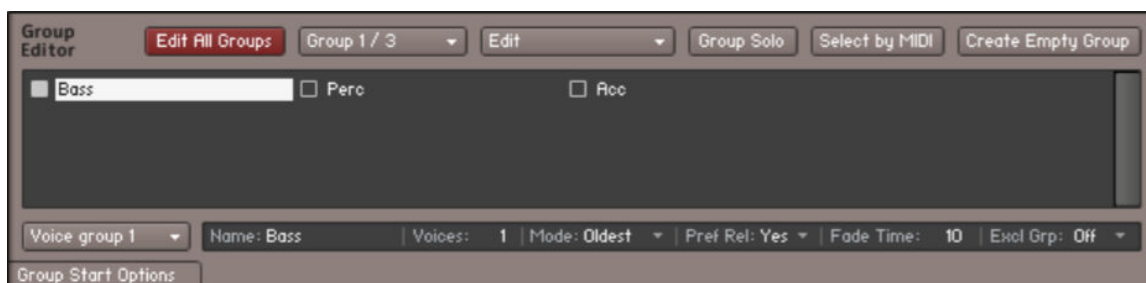

*The Group Editor, opened on an Instrument which contains 3 Groups. Only the "Bass" Group is currently selected both for display and for editing.*

The Group Editor is divided into four sections:

- At its top, a control header provides several buttons and drop-down menus.
- The largest amount of space is taken up by the Groups list below, which will display all Groups in your Instruments as a scrollable list.

- At the bottom of the editor, you'll find a row of several parameters that pertain to the assignment of Voice Groups
- The **Group Start Options** button in the lower left corner will show or hide an additional set of rows which contain the Group start conditions.

Let's take a look at what each of these elements does.

## Control Header

This row of buttons and drop-down menus at the top of the Group Editor provides common utility functions for easy Group management. The following sections will explain each of these elements, from left to right, in detail.



The header of the Group Editor contains a number of options and utility functions.

## Edit All Groups

If this button is activated, all parameters that you adjust on the Group level from that point on will affect all Groups in the currently edited Instrument. This button is just a convenient shortcut for checking all edit boxes in the Group list; the same function is also available via a button located in the Rack header when you're in Instrument Edit mode.

As an example, suppose you have three Groups with a modulation assignment for each, which assigns an LFO to their pitch in order to create a vibrato effect. If you decide now that the vibrato effect is a little too strong across all Groups, you don't need to change the respective modulation intensity in each Group. Just activate the **Edit All Groups** button and decrease the respective Intensity parameter in one of the Groups; the respective parameters in all other Groups will change with it.

We recommend that you always switch this feature off right after you've used it. If you leave it on and make any adjustments to Group parameters later without keeping it in mind, you'll potentially destroy carefully tweaked parameter settings in other Groups.

You can find more information on how to change parameters across Groups in section [Group List](#).

## Group Selector

Next to the **Edit All Groups** button, you'll notice a label that indicates the currently selected Group, as well as the total number of Groups in your Instrument. Clicking on it opens a drop-down menu that allows you to select another Group; clicking on the Group name that's displayed in the Rack header when you're in Instrument Edit mode will do the same. In contrast to clicking on a name in the Group list, however, this action won't enable the selected Group for editing at the same time, which makes it the preferred way of selecting Groups if you just want to check out their contents without editing them.

## Edit

This drop-down menu contains a number of utility functions, most of which act on all Groups that are currently selected in the Group list. Note that this selection is different from enabling Groups for editing; selected Groups will be indicated with a filled or hollow rectangle around their name in the Group list, while Groups that are activated for editing will be indicated with a checked box in front of their name.

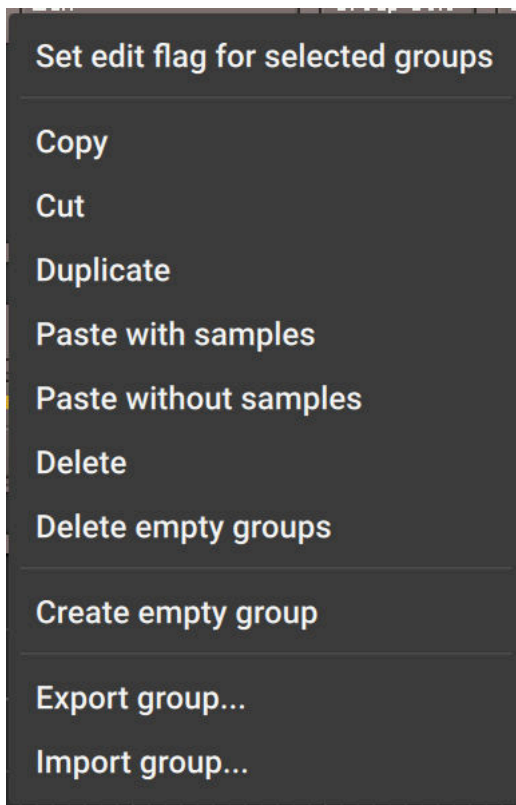

*The Edit menu contains editing commands that operate on the currently selected Group(s).*

The Edit menu is also available as a right-click context menu both inside the Group Editor and the **Groups** tab of the Monitor.

Let's take a look at each function in this menu:

- **Set edit flag for selected groups:** This option checks the Edit Flag for all Groups that are currently selected in the Groups List. This allows you to check multiple Groups for editing quickly, without using the **Edit All Groups** option, which only allows an all or one mode of editing Groups.
- **Copy:** Copies the selected Groups to the clipboard.
- **Cut:** Moves the selected Group and its Zones to the clipboard for later use, removing the Group from the Group list in the process.



Using the cut, copy, and paste commands in the Group Editor, you can move and copy Groups between Instruments. This even works across multiple Kontakt instances and sessions.

- **Duplicate:** Creates identical copies of the selected Groups.
- **Paste with samples:** Inserts the contents of the Group clipboard into the Group list, leaving their Zones and referenced Sample information intact. Note that if you copied the respective Group(s) beforehand, therefore creating duplicates by pasting them, the Zones will be duplicated along with the Groups, so later changes to the Zone parameters in one Group won't affect the Zones of its copy.
- **Paste without samples:** Inserts the contents of the Group clipboard into the Group list, omitting any Zones in the process. This way, you'll get empty Groups that replicate the settings of a previously copied or cut Group.

- **Delete:** Deletes any selected Groups. If any of the Groups still contain Zones, they will be deleted as well; in such cases, you'll be asked if you're sure about this.
- **Delete empty groups:** Deletes all Groups that don't contain any Zones.
- **Create empty group:** Creates a new empty group.
- **Export group...:** This function allows you to save the currently selected Group to an .nkg file on your hard disk, which you can re-use in other Instruments. In contrast to other commands that act on all selected Groups, this one doesn't handle multiple selections; only the currently displayed Group, which will be indicated in the Group list with a filled rectangle around its name, will be saved. When you click this function, a pop-up dialog will ask you to specify a location and name for the file. In addition, you can also choose between different ways of how the referenced Samples in this Group should be handled:
  - **Patch Only** won't save the Samples, but reference them at their original positions in the Group file.
  - **Patch + Samples** will save the Samples along with the Group file in a definable location
  - **Monolith** will combine both Group data and its referenced Samples into one large file.
- **Import group...:** Load a Group in .nkg format and add it to your Instrument, along with all of its contained Zones. This command also allows you to import Battery 3 Cells.

### Group Solo

If this button is activated, all Groups except the currently selected one will be muted. This lets you conveniently check out the contents of a Group when working with multiple Groups, whose Zones may overlap.

### Select by MIDI

If this button is activated, you can select Groups by playing notes on your keyboard. When Kontakt receives a MIDI note, it checks all Groups for Zones that match its note number and velocity, and selects any Groups that contain such Zones in the Group list. This makes for a very intuitive way to quickly switch between Groups; suppose you're working on a drum set with every instrument being assigned to a separate Group. Instead of locating the bass drum Group within the Group list and clicking on its name, you just play a bass drum note on your keyboard, and the corresponding Group will be automatically selected.

### Group List

This pane displays a list of all Groups in your currently edited Instrument. If the number of Groups won't fit into the window, a scroll bar will appear on its right side. Here you can select Groups and enable them for editing.

In order to select a Group for viewing, just click its name; it will be highlighted with a filled rectangle, and all currently visible controls on the Group level will now show the parameters of this Group. Any command you select from the Edit menu of the Group Editor will now operate on this Group only. Double-clicking an entry allows you to change its name.

While only one Group can be displayed at any time (which will always be indicated with a filled rectangle in the Group list), you can select multiple Groups by holding the [Ctrl] key ([Cmd] on OS X) while clicking on separate Groups to add them to your selection, or holding the [Shift] key while clicking on a second entry to include all Groups between the first and the last one in your selection. This selection affects only upon which Groups the commands in the Edit menus will act; to find out how to change parameters across multiple Groups, read on.

You will notice a small check box next to each Group name in the Group list, which will always be activated on the list entry on which you clicked last.





The check box next to a Group name indicates whether this Group is selected for editing.

It indicates whether the parameters of the respective Group will be changed along when you do any adjustments. In other words, when you enable the check boxes next to multiple Groups and then move any controls of the currently displayed Group (such as the **Volume** or **Pan** knob of the Amplifier Module), the parameters of the other Groups will be affected as well.

This transfer happens in an absolute fashion; settings in the other Groups will simply be replaced with the new ones. This can easily result in unintentional changes to parameters in other Groups than the currently visible one, so be sure to check whether other Groups are currently activated for editing before you do any adjustments on Group level modules. This is made easier by a text indicator in the Rack header: as long as you're in Instrument Edit mode, it will indicate how many and which Groups are currently activated for editing.

Note that the **Monitor** tab in the Side pane offers you alternate views for the functions described in this section. These can greatly simplify managing Groups and changing parameters across Groups; depending on your preference, you might want to use them instead of the Group list for some operations. The **Monitor** tab is described in detail in section [Monitor Tab](#).

## Voice Groups

The concept of Voice Groups allows you to fine-tune the way in which Kontakt allocates audio voices to Groups. Please don't confuse Voice Groups with Groups; in spite of the similar names, they're entirely different concepts. To understand Voice Groups, let's begin with an example.

A typical sampler program of a drum set contains at least one sample of a closed hi-hat and one of an opened hi-hat. As the ringing sound of an opened hi-hat will be immediately cut off when the drummer closes it, we can conclude that these sounds never occur at the same time; therefore, we could simulate this behavior by limiting the maximum voice count of the hi-hat to one. As each played Sample will take one voice, and the last played Sample will have priority over any Samples that were triggered before by default, playing the closed hi-hat Sample will cut a still ringing open hi-hat Sample off.

How can we accomplish this? You can adjust the maximum number of voices to be used for an Instrument in the Instrument Header, but this would restrict all other parts of the drum kit to one voice as well. A more practical way would be to make use of the Voice Group concept: it allows you to create a voice allocation setting and apply it to any number of Groups in your Instrument.

In contrast to Groups, you don't have to create or manage Voice Groups; instead, 128 of them are pre-defined in every Instrument. By default, Groups are not assigned to any Voice Group, which means they will share the pool of voices as defined in the Instrument Header with all other Groups. By assigning some of your Groups to one of the 128 Voice Groups and adjusting this Voice Group's parameters, you can define a new set of voice allocation rules for these Groups. For instance, you could solve the hi-hat problem by assigning the closed and open hi-hat Groups to Voice Group 1, then set the voice count of this Voice Group to one. There are more parameters to a Voice Group than its maximum voice count; these will be explained later.

The 128 Voice Groups can be assigned and edited in the strip below the Group list of the Group Editor. Selecting a Voice Group from the drop-down menu at its left will assign all currently selected Groups to this Voice Group, and display its parameters in the fields to the right.

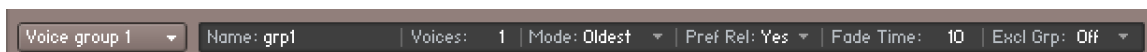

The row of parameters below the Group list allows you to assign and adjust Voice Groups.

Here's a run-down of these parameters, from left to right:

- **Name:** Displays the name of the selected voice group. Clicking in this field allows you to change the name.
- **Voices:** Adjusts the maximum number of voices that can be used by the Groups in this Voice Group. If a Sample is triggered and the maximum voice count has already been reached, voices of Samples that would otherwise still sound will be “sacrificed” and recycled.
- **Mode:** This setting decides which of the currently allocated voices will be sacrificed and recycled if a newly triggered Sample would otherwise exceed the maximum voice count for this Voice Group:
  - **Kill Any:** Let Kontakt decide what to do.
  - **Kill Oldest:** The oldest, still playing Sample will be cut off.
  - **Kill Newest:** The most recently triggered Sample will be cut off.
  - **Kill Highest:** The note with the highest pitch will be cut off.
  - **Kill Lowest:** The note with the lowest pitch will be cut off.
- **Pref.Rel:** If this button is activated and the Voice Group runs out of voices, Kontakt will give already released notes a higher priority when it decides which voices to keep.
- **FadeTime:** Adjusts how long a sacrificed voice will fade out before it disappears. The fadeout length is specified in milliseconds. This may cause the overall number of voices to temporarily exceed the maximum value.
- **Excl.Grp:** This drop-down menu allows you to assign the current Voice Group to one of 16 Exclusive Groups. Assigning two or more Voice Groups to the same Exclusive Group will cause Samples from one Voice Group to cut off all still-sounding Samples from the other Voice Groups assigned to the Exclusive Group. When you re-consider our hi-hat example, you’ll notice that an alternative solution would be keeping the samples in separate Groups and assigning them to the same Exclusive Group. This has the added benefit that you can edit the Group-level signal processing of both samples separately.

## Group Start Options

By default, each Zone in a Group will always play its assigned Sample when a note is received that matches its keyboard and velocity range. However, there are applications that demand for more control about when the Zones in a Group will come active. Some examples include:

- When you sample an acoustic Instrument, you might want to provide multiple, slightly different Samples for each note and velocity range, then have Kontakt cycle between them in a round-robin fashion when note repetitions are played; this eliminates the dreaded “machine gun effect”, which is a giveaway of sampled instruments. For this, you need a way to make each Group wait for its turn before it sounds.
- With the advent of large, modern sample libraries, it has become customary to let the user switch between different articulations with keys on his master keyboard that are unused by the Instrument’s Zones; these so-called keyswitches require a way to make Groups only come active when their respective keyswitch was the last received one.
- You might want to switch between Groups depending on the value of a MIDI controller; for instance, lots of modern piano libraries use separate sample sets for notes which are played with the sustain pedal depressed and released.

The Group Start Options allow you to define a range of conditions that have to be met before the respective Group will become active and can output any sound. The list of these conditions is hidden from the Group Editor view by default; you can show it by clicking on the **Group Start Options** button in the lower left corner of the Group Editor.

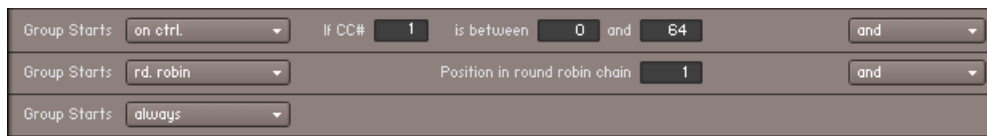

Multiple Group start conditions, combined with "and" operators. This means that all specified conditions must be met before the Group becomes active.

Each row of this list has a drop-down menu at its left side.

► To add a condition to the list, select its general type from this menu.

To the right of the menu, Kontakt will then show the respective parameters that belong to the respective condition along with explanatory labels, as well as an operator drop-down menu that logically combines this entry with the next one.

The Group Start Options list includes the following types of conditions:

- **Always:** This is a no-operation value. If it's the only value in the list, the selected Group will always be active. In lists with more than one row, this value serves as a marker for the last row in the list, as well as an entry that deletes rows from the list when you choose it.
- **Start on Key:** This condition lets you define keyswitches. A Group with this condition will be deactivated until a trigger note within the defined range is received; it will be deactivated again when another Group in your Instrument with a **Start on Key** condition will come active, so that you can switch between Groups with single key strokes.
- **Start on Controller:** The Group will come active when Kontakt receives a MIDI controller within a specific range. It will be deactivated again when a controller value outside the range is received.
- **Cycle Round Robin:** All Groups that have this condition in their Group Start Options will be cycled in a round-robin fashion on each note. Among other things, you can use this feature to add realistic variations to note repetitions, or automatically alternate between left and right strokes on percussion instruments.
- **Cycle Random:** Like **Cycle Round Robin**, but notes will be cycled randomly instead of sequentially.
- **Slice Trigger:** This option was used by slice Groups in Kontakt 2. It is provided for backwards compatibility and should not be used explicitly.

By adding multiple conditions to the list and connecting them with the logical operators you'll find in the drop-down menu at the right side, you can create very complex combinations of conditions. Note that the last entry of the list (which will be an **always** condition) won't be taken into account when your list contains at least another condition entry.

## Mapping Editor

Samples, which are essentially audio files by another name, are made playable in Kontakt by creating Zones that reference these files. A Zone is a kind of container that holds information in order to tell Kontakt which Sample to play when a specific note is received. A Zone needs to specify a range of note and velocity values that it should respond to. In addition, a Zone can contain other values, like volume, pan, and tune adjustments.

All of the facilities required to specify the parameters of a Zone (and a few more) are provided in the Mapping Editor.

► Click on the **Mapping Editor** button just below the Instrument Header to toggle the Mapping Editor view on and off.

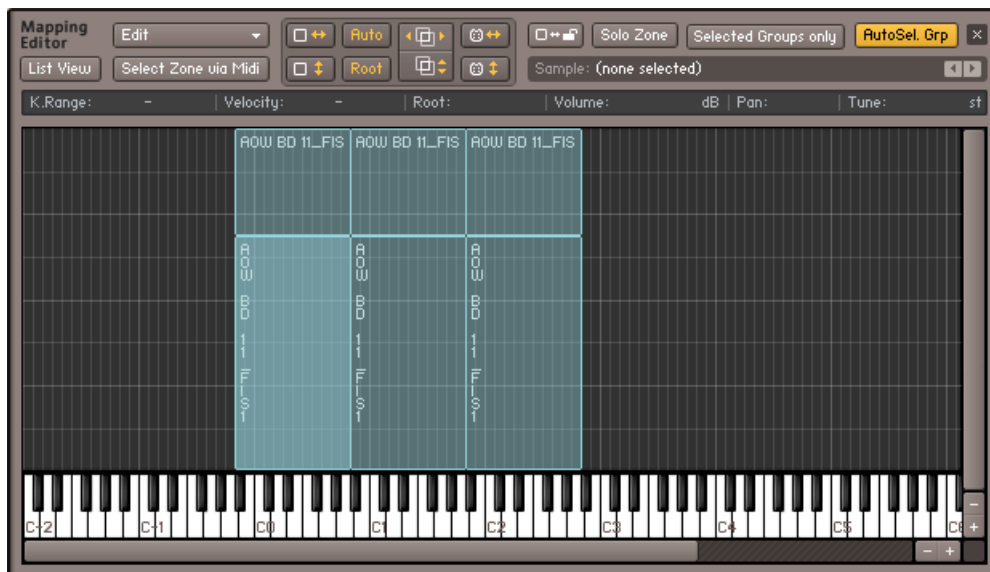

The Mapping Editor, displaying the Zones of an Instrument which contains 3-layer velocity switches throughout its playable range.

The Mapping Editor consists of three parts:

- At the top, a control strip with two rows of buttons and menus provides access to a number of utility functions that operate on your selected Zones.
- A status line displays the parameters of the currently selected Zone and allows you to change it.
- The largest space is taken up by the Zone grid, a two-dimensional panel with a keyboard at its bottom. It displays and lets you change the key range (horizontal axis) and velocity range (vertical axis) of each Zone in an intuitive, graphical way. Scroll bars at the right and lower border allow you to move the view around, as well as zoom vertically and horizontally by clicking the "-" and "+" buttons; the "-" and "+" keys on the number pad of your keyboard will do the same. Alternatively, you can quickly zoom into a specific region by holding the Alt key while clicking and dragging the mouse on the grid; this will open a "rubber band" selection frame, which will fill up the whole view with its selected area when you release the mouse button. To zoom out again, just click somewhere on the grid while holding the Alt key. When you play a note on your MIDI keyboard, a small red marker should appear above the corresponding key of the on-screen keyboard, with higher velocities being indicated with a higher position in the grid.

## Mapping Samples Manually

You can manually create Zones by dragging one or multiple Samples from the Side pane or your desktop into the Zone grid of the Mapping Editor. While dragging, a highlighted region will tell you where Kontakt would place the Zone(s) on the keyboard. When you release the mouse button, the Zones will be created; if you change your mind and don't want to add new Zones, just move your mouse outside the Mapping Editor and release the button.

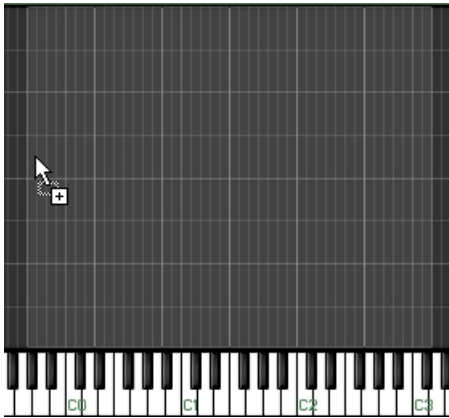

While you keep your mouse button depressed, Kontakt will highlight the pattern in which it would map new Zones to the keyboard.

The way Kontakt will distribute the new Zone(s) depends on your mouse position and whether you're dragging one or multiple Samples:

- Dragging a single Sample into the Zone grid will create a Zone that spans the entire velocity range, and will be placed on one or several adjacent keys. When you move the mouse all the way to the bottom of the grid, the Zone will be assigned to a single key; moving the mouse upwards will gradually enlarge the keyboard range of the Zone, until it spans the entire keyboard when you're at the top of the grid.
- Dragging multiple Samples into the Zone grid will create a corresponding number of adjacent, non-overlapping Zones, starting with the key at your horizontal mouse position. Just like when you drag single Samples, the vertical mouse position will adjust the size of each Zone's key range. When you move your mouse all the way to the top of the grid, all Samples will be layered in overlapping Zones that span the whole key range.
- Dragging multiple Samples onto a key of the keyboard below the grid will create a corresponding number of Zones that evenly divide the velocity range on that key. This makes for a convenient way to quickly create velocity switches.

Note that when you drag multiple samples from the Side pane into the Mapping Editor, the sort order in which they appeared in the Side pane will also determine the order in which the corresponding Zones will be placed. For instance, if you'd like to create an eight-way velocity switch out of samples named "Piano-C3-1.wav" through "Piano-C3-8.wav", you should make sure that the Samples list in the Side pane is sorted by name in ascending order before you select and drag the Samples into the Mapping Editor.

In addition to Samples, you can also drag one or multiple sliced loops into the Mapping Editor to place them on the keyboard. In this case, the newly created Zones won't belong to the currently selected Group; instead, a new Group will be created for each Loop with its Source Module set to Beat Machine mode.

## Mapping Samples Automatically

Placing Zones manually by dragging Samples from the Side pane into the Zone grid works well if your Instrument won't contain a lot of Zones, or if your Samples are conveniently named in a way that makes it possible to pre-sort them in the Side pane before you create Zones out of them. But what if the samples of your violin set are not named "Violin-1.wav" through "Violin-14.wav", but instead "Violin-G2-A2" through "Violin-A#5-C6"? There's no way to get the Side pane to sort them in any meaningful way.

For scenarios like this, the Mapping Editor includes an Auto-Mapping feature. It consists of a customizable filename scanner that first attempts to determine which parts of your Sample's filenames could contain valuable information, then lets you assign to which Zone parameters these parts should be mapped.

To use the Auto-Mapping feature, you'll have to create Zones out of your Samples first by dragging them into the Mapping Editor as described above. While doing this, you won't have to care about aspects that can be derived from the Sample filenames later. For instance, if your filenames contain the key range, you don't need to place the Zones anywhere particular; they will be moved to their correct destinations by the Auto-Mapping feature anyway.

In the next step, mark all Zones in the Mapping Editor upon which you want the Auto-Mapping feature to act. You can select multiple Zones either by holding the [Shift] key while clicking on them, or by clicking on the grid background and dragging the mouse to open a "rubber band" selection frame. When all Zones you want to process are selected, open the **Edit** drop-down menu at the top of the Mapping Editor and choose **Auto Map – Setup**. A dialog window will appear that displays the result of the filename scanning process.

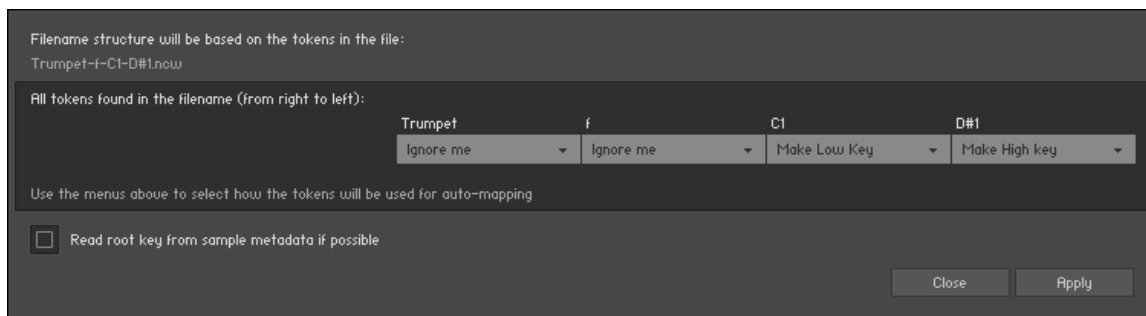

The Auto Mapping dialog, displaying a filename that has been split up into four tokens.

At the top of this dialog, you can see which filename has been used to determine where the interesting parts of the filename could be. These so-called "tokens" are any strings that appear in the filename and are separated from each other with non-alphanumeric characters like spaces, dashes, or underscores. Below, the filename is displayed again, this time split up into its determined tokens, with a drop-down menu below each of them. These menus allow you to specify for each token whether it shall be ignored or used to derive any Zone information. For example, if your Samples are named similar to "Trumpet-f-C1-D#1.wav", with the "f" indicating the dynamic layer and the notes representing the low and high endpoints of the key range, you can leave the drop-down menu of the first token ("Trumpet") at its **Ignore Me** entry, while setting the menus of the second, third and fourth tokens ("f", "C1" and "D#1") to **Make Group Name**, **Make Low Key**, **Make High Key** and **Set to Single Key** respectively.



Tokens marked "Ignore me" won't be used for any automatic Zone adjustment.

Of course, this applies only if you want to separate multiple dynamic layers into Groups, otherwise you can leave the second menu set to **Ignore Me** as well.

When you enable the **Read root key from sample metadata if possible** option at the bottom of the dialog, Kontakt will read and use the root key information that's embedded in some WAV and AIFF files, if available, instead of trying to get it from the filename. Once the settings accurately reflect the information contained in your filenames, click the **Close** button at the bottom of the dialog.

Now, with the Zones still selected, choose the **Auto map selected** command from the **Edit** menu at the top of the Mapping Editor, or use the keyboard shortcut [Ctrl] + T ([Cmd] + T on Mac OS X). If you correctly identified all filename tokens in the previous step, Kontakt will now automatically arrange and place the Zones according to the information it gets from the filenames of their referenced Samples.

## Managing Zones

Once you've created Zones for your Samples, you can take care of adjusting their parameters to your needs. Each Zone carries the following parameters with it:

- **Key Range:** This is the range of notes on your keyboard to which the Zone will respond. For instance, a keyboard range of "C3–D#3" tells Kontakt that the respective Zone shall be played when a C3, C#3, D3, or D#3 note is received. If a Zone is being assigned to a single key (as it's the case with chromatically sampled Instruments), the keyboard range will look similar to "C3–C3".
- **Vel Range:** The values here specify the lowest and highest velocity values the Zone will respond. A Zone that will be triggered regardless of the velocity will have a velocity range of "0–127".
- **Root Key:** This is the pitch at which the sample was originally recorded. When the Zone is being played at this key, no transposition will take place. Note that an incorrect root key value will result in a transposition offset of the whole Zone, as Kontakt will transpose Zones based on the distance between their root key and the actual received note. Also, for any transposition to occur at all, the **Tracking** parameter of the respective Group's Source Module needs to be activated.
- **Volume:** This parameter lets you specify a volume offset for each Zone. The default volume setting of all Zones is 0 dB.
- **Pan:** This parameter allows you to place each Zone independently within the stereo panorama.
- **Tune:** This parameter lets you change the tuning of a Zone within a range of +/- 36 semitones.

Note that the last three parameters are mainly intended for a non-destructive correction of Samples which deviate in volume, panorama position, or tuning. They work in combination with the identically named parameters of the Source and Amplifier modules. If you want to modulate these parameters on a per-Zone basis, read about Zone Envelopes in section [Zone Envelopes](#).

## Editing Parameters in the Status Bar

In order to view and change the parameters of a Zone, first select it in the Zone grid of the Mapping Editor by clicking on it. All parameters of the currently selected Zone will now be displayed in the status bar above the Zone grid. You can change a parameter by clicking on its value and dragging your mouse upwards or downwards. While this is the only way to change the volume, pan and tune parameters of a Zone, there are several alternate ways to adjust its keyboard range, velocity range, or root key.

## Editing Parameters Graphically

You can change the keyboard and velocity range of a Zone, as well as its root key, graphically within the Zone grid of the Mapping Editor:

- Clicking into a Zone and moving the mouse horizontally will move the whole Zone across the keyboard. Using the left and right cursor keys while holding [Ctrl] ([Cmd] on Mac OS X) will move the currently selected Zone(s) across the keyboard.
- Clicking on the left or right border of a Zone (the mouse cursor will change when it's right on the border) and dragging it horizontally, thereby changing the horizontal size of the Zone, will change that Zone's keyboard range. Using the left and right cursor keys while holding [Shift] and [Ctrl] ([Cmd] on Mac OS X) will adjust the high key limit of the selected Zone's key range.



- Clicking on the upper or lower border of a Zone and dragging it vertically will change this Zone's velocity range. Using the up and down cursor keys while holding [Ctrl] ([Cmd] on Mac OS X) will move the velocity range of the currently selected Zone(s) by two velocity steps; holding [Shift] and [Ctrl] will change their upper velocity limits.
- Clicking on the yellow key on the keyboard below the Zone grid and dragging it horizontally will change the Zone's root key.
- [Ctrl]-clicking and dragging while your mouse is on the left or right border of a Zone will create a Zone crossfade. This function will be explained below.
- Alt-clicking and dragging will open a "rubber band" zoom frame; when you release the mouse button, the contents inside the selection frame will zoom in to fill the whole pane. To zoom out again, just Alt-click somewhere on the grid.

You can select multiple Zones by clicking on them while holding the [Shift] key, or clicking on an empty space of the grid and dragging the mouse to open a "rubber band" selection (when you hold [Shift], you can open the selection frame at any point, also on Zones).



If multiple Zones overlap and you can't reach one that's hidden behind another, try holding the [Ctrl] key ([Cmd] on Mac OS X) while clicking inside them repeatedly; this will cycle through all Zones you're pointing at.

By using the cursor keys while holding [Shift], you can add adjacent Zones to your current selection. This way, you can use the described methods to move or modify the Zones in unison; the status bar, however, will only show values that are identical across all selected Zones when multiple Zones are selected.

### Editing Parameters via MIDI

A third alternative that lets you change the keyboard and velocity ranges of a Zone in an intuitive way is using your MIDI keyboard. After you've selected a Zone in the Zone grid of the Mapping Editor, enable one of the buttons depicted with a small MIDI jack and a double arrow in the control strip, or both.



*Enabling MIDI Mapping*

The button with a horizontal arrow lets you change the keyboard range, the one with a vertical arrow lets you change the velocity range.

When these are active, play two keys on your keyboard; it doesn't matter whether you play them at the same time or in succession. Depending which of the two buttons you have activated, Kontakt will use the note numbers and the velocity of both notes as endpoints for the Zone's new keyboard and/or velocity range.

### Control Strip

The control strip is located at the top of the Mapping Editor and consists of two rows of controls. This is where you can find most utility functions for managing and editing your Zones.





The Control Strip of the Mapping Editor provides a number of options and utility functions.

Let's take a look at the elements of the control strip:

**Edit menu:** This button opens a drop-down menu with utility functions that operate on all currently selected Zones, such as clipboard operations, functions for assigning Zones to Groups, and batch processes. You can find a thorough explanation of all entries in this menu in the next section of this chapter.

**List View:** This button switches the Zone grid to an alternate view mode that displays all Groups and their contained Zones in a hierarchical list structure at the left side.



When you're in list view, you can expand or collapse all Groups at once by holding [Shift] when you click an expand/collapse button.

This mode is especially handy when you're working with lots of Zones that overlap in large areas, as Zones that are hidden behind others can be difficult to select and edit in the normal, flat view. The downside of the list view is that it doesn't convey any information about the velocity ranges; the only way to modify these is by editing them numerically in the status bar after you have selected a Zone. Just like the default view, the list view can be moved around with the scrollbars and zoomed with either the zoom buttons or by clicking and dragging a "rubber band" zoom frame while holding the Alt key.

**Select Zone by MIDI:** If this button is activated, any incoming MIDI note will automatically select any Zone(s) that match its note number and velocity. The function works similarly to the Select by MIDI feature of the Group Editor.

**Auto-Spread Zone Key Ranges:** This function automatically fills "holes" in your key mapping by successively extending the key range of each selected Zone to both sides until it "touches" its neighbors. The algorithm ignores the root keys of the selected Zones; it simply uses the current key range as a starting point for extension. If you want the root keys to be accounted for, use the Auto-Spread Key Ranges via Root Key function instead. The Auto-Spread Zone Key Ranges function is also available in the Edit menu.

**Auto-Spread Velocity Ranges:** This function works similarly to Auto-Spread Zone Key Ranges, but operates on the velocity range of each selected Zone instead of the key range. This function is also available in the Edit menu.

**Auto-Map Selected:** When you click the **Auto** button, the Auto-Mapping feature will change the parameters and placement of each selected Zone according to information it has derived from its Sample's filename. This function is also available in the Edit menu. The Auto-Mapping feature is explained in detail in the previous section of this chapter.

**Auto-Spread Key Ranges via Root Key (Root):** This function works similarly to the Auto-Spread Zone Key Ranges command; however, it aims for the smallest possible maximum transposition that can occur in each Zone by accounting for the root keys and trying to keep them in the center of their respective Zone. This function is also available in the Edit menu.

**Resolve Overlapping Key Ranges:** This function eliminates key range overlaps between the selected Zones by successively shrinking the key range of each Zone until it doesn't overlap its neighbor anymore. It aims for optimal utilization of root keys (and consequently, the smallest possible amount of transposition). This function is also available in the Edit menu and via the keyboard shortcut [Ctrl]-R ([Cmd]-R on Mac OS X).

**Resolve Overlapping Velocity Ranges:** This function works similarly to the Resolve Overlapping Key Ranges command, but operates on the velocity ranges of the selected Zones. It's also available in the Edit menu and via the keyboard shortcut [Shift] + [Ctrl] + [R] ([Shift] + [Cmd] + [R] on Mac OS X).

**Set Key Range via MIDI:** If this button is activated and a Zone is selected, Kontakt will use the next two incoming MIDI notes as the endpoints of a new key range for the selected Zone. This function is described in the previous section.

**Set Velocity Range via MIDI:** If this button is activated and a Zone is selected, Kontakt will use the velocities of the next two incoming MIDI notes as the endpoints of a new velocity range for the selected Zone. This function is described in the previous section.

**Lock Zones:** When this button is activated, the key and velocity ranges of all Zones will be protected from being changed graphically inside the Zone grid. This can be handy when you're doing editing tasks that require you to switch between Zones a lot, and want to avoid accidentally moving one of them or changing its key or velocity ranges.

**Zone Solo:** This button will mute all Zones in your Instrument except of the currently selected one(s). Once activated, the solo function will follow your selection, so you can quickly check out the contents of specific Zones acoustically.

**Selected Groups Only:** When this button is activated, the Mapping Editor will only show Zones that belong to the currently selected Group. To help you keep the overview, other Zones will be displayed dimly in the background, but won't be able for selection or editing.

**Auto Sel Grp:** When this button is activated, the Group selection will follow your Zone selection. In other words, selecting a Zone will automatically select the respective Group to which it belongs in the Group Editor.

**Sample Field:** This text field displays the filename of the Sample that's assigned to the currently selected Zone. When you hover the mouse pointer over this field, Kontakt will additionally display the full path to the Sample file. Using the arrow buttons on the right side of the field, you can assign a new Sample to the selected Zone; the buttons will switch to the previous or next Sample within the folder of the current one.

## Edit Menu

This drop-down menu contains utility functions that operate on your currently selected Zones. In addition to clipboard commands and functions that allow you to re-assign Zones to different Groups, it also contains a range of batch functions that are designed to operate on multiple Zones, commands for controlling the Authentic Expression Technology (as described in section [AET Filter](#)), and some options that affect the display and editing behavior of the Mapping Editor. Let's have a look at what you can find in the Edit menu, from top to bottom:

- **Cut:** Moves the selected Zones to the clipboard for later use, removing them from the Zone grid in the process. Using the clipboard, you can move Zones from one Instrument to another, even across different Kontakt instances.
- **Copy:** Copies the selected Zones to the clipboard.
- **Duplicate:** Creates identical copies of the selected Zones. These copies will be placed on top of the originals and will be selected after the process, so you can move them to a different place right away if you wish. The keyboard shortcut for this function is [Ctrl]-D ([Cmd]-D on Mac OS X).
- **Paste:** Inserts the contents of the Zone clipboard into the Mapping Editor. The Zones will appear in the same place they were cut or copied from.
- **Delete:** Removes the selected Zones from the Mapping Editor.

- **Delete all zones with missing samples:** Removes Zones that have missing samples from the Mapping Editor.
- **Exchange sample...:** Opens a file chooser dialog that lets you assign a new Sample to the selected Zone. This operation will keep the other Zone parameters, such as key and velocity ranges, intact.
- **Reveal sample in Explorer/Finder...:** Opens the folder where the sample is located in either the explorer (Windows) or finder (macOS).
- **Select all zones:** Selects all Zones in your Instrument, including those in other Groups than the currently selected one, even if the **Selected Groups Only** button is activated.
- **Deselect all zones:** Clears all active Zone selections, if any.
- **Move to new group:** This entry opens a sub-menu that contains following options for moving the currently selected Zones:
  - **Empty group:** Creates a new Group with default settings and re-assigns all currently selected Zones to it. Use this function if you want to separate a number of Zones from your current Group and use them to build a new Group from scratch.
  - **Clone group:** Creates a new Group that replicates the settings of the Group to which the first selected Zone is assigned, then re-assigns all currently selected Zones to it. This process won't change the functionality of your Instrument, as the new Group will behave exactly as the old one did; however, it allows you to change parameters of the new Group separately from the original Group.
  - **Each zone to its own empty group:** This function works similarly to the **Empty group** command, but instead of creating a single Group and moving all selected Zones into it, it will create a separate, empty Group for each Zone.
  - **Each zone to its own clone group:** This function works similarly to the **Clone group** command, but will create a separate Group for each Zone, which replicates the settings of the original Group.
- **Move to existing group:** This entry opens a sub-menu that contains a list of all Groups in your current Instrument; by selecting one of them, all currently selected Zones will be moved to this Group.
- **Batch functions:** This entry opens a sub-menu with utility functions designed to operate on multiple Zones. Its contents will be described in the next section of this chapter.
- **AET functions:** This entry opens a sub-menu with the following functions:
  - **Create AET morph layer...:** Opens a dialog that lets you analyze the Samples of the selected Zones and save them to a new Morph Layer. These layers constitute the basic building blocks of the Authentic Expression Technology introduced in Kontakt 4. Please refer to section [AET Filter](#) for a thorough description of AET.
  - **Open AET morph map editor...:** Opens a dialog that lets you combine one or more Morph Layers into a Morph Map.
  - **Auto-add AET velocity morph:** This is a convenient function that carries out all necessary steps of building a standard velocity morph across the selected Zones for you. Please refer to section [Creating a Velocity Morph](#) to find out how to use this feature.
- **Auto-map functions:** Contains a number of entries that replicate the functions of the corresponding buttons which you can find in the control strip; they are explained in detail in the previous section of this chapter.
  - **Auto-map setup...:** Opens the setup dialog that lets you identify the tokens of Sample filenames for later Auto-Mapping. The Auto-Mapping feature is described in detail in section [Mapping Samples Automatically](#).

- **Map mode:** These five settings affect how the Mapping Editor will behave when you drag multiple Samples from the Side pane into the Zone grid:
  - **Chromatic:** This is the default setting. The Mapping Editor will create adjacent Zones across both black and white keys, with the vertical mouse position adjusting the size of each Zone.
  - **White Keys Only:** New Zones will be assigned to single, adjacent white keys.
  - **Black Keys Only:** New Zones will be assigned to single, adjacent black keys.
  - **Snap to White Keys:** This mode works similarly to **Chromatic**, but the Mapping Editor will place the low key of each Zone on a white key.
  - **Snap to Black Keys:** The low key of each Zone will be placed on a black key.
- **Move root key with zones:** When activated, moving a Zone will move its root key along with it. This way, the pitch of the Zone will stay the same when it's being moved.
- **Display options:** This submenu contains various options for what should or should not be displayed in the Mapping Editor.
  - **Show sample names:** If activated, the filenames of the assigned Samples will be displayed within the rectangles that represent each Zone in the Zone grid. Note that the name will be hidden when a Zone rectangle is too small; if you'd still like to see it, try zooming in until the name appears.
  - **Show empty user zones:** If activated, user zones that do not have a sample assigned to them will be displayed. This also means that they could show as being out of range of the Mapping Editor, if other zone parameters (like key and velocity range) are at their default values.
  - **Show zones from unselected groups:** If activated, zones belonging to groups which are not selected in Group Editor will be displayed.
  - **Show events:** Entries in this submenu show or hide incoming, script generated and events ignored in script, in the Mapping Editor.

## Batch Functions

You can find these tools in the **Batch functions** submenu of the Edit menu. In addition to functions that place root keys in relation to the respective Zone borders, the menu includes several utility operations that let you create crossfades between Zones, which needs a brief introduction.

When you create Sample sets of tonal instruments that don't include a Sample for each note, the notes that haven't been sampled need to derive their signal from the Samples of nearby notes. This is usually done by transposing these "native" Samples upwards or downwards. This method has a downside – the necessary re-sampling process can "skew" the sound character of your instrument, especially when transposition over a wider note range is required. Consequentially, this means that two consecutive notes on a scale which happen to cross the "border" between two Zones, and thus are both transposed versions of different Samples, can sound dissimilar.

The same problem can arise with velocity switched Sample sets; suppose you're using four Samples per note, each assigned to one of four equally large velocity ranges. Especially when you're sampling an acoustic instrument, it can easily happen that two consecutive notes with only marginally different velocity values still happen to fall into two different velocity ranges, thus resulting in noticeably different timbres.

Crossfades provide a way to counteract these effects. The basic idea is that overlapping your Zones and creating a crossfade between them, thus making them blend into each other within the overlapping parts, will mask the difference in sound for notes that fall "between" them.

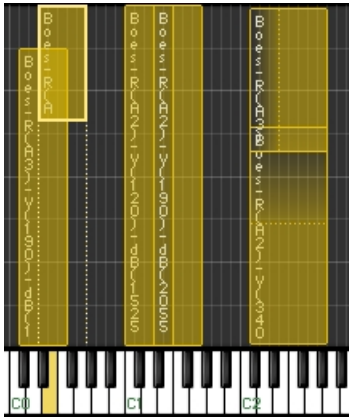

Crossfades are being depicted with colored gradients.

Consider this example: You're sampling an instrument in minor thirds and have just sampled D and F. You create two Zones out of the Samples and extend them a major second to both sides. Now, Zone 1 covers the key range between C and E, with its root key being D. Zone 2 has its root key on F and covers the key range between D# and G. Notice that the Zones overlap on D# and E, where both will be transposed. Now you create a key crossfade on both Zones; as a result, D# and E notes will play a blend of both Zones, with the D Zone's Sample being predominant on D# notes, and the F Zone's Sample being predominant on E notes. Of course, this method works just as well with larger sampling intervals. Just make sure that your Zones overlap in ranges you'd like to be crossfaded, whether in key (horizontal) or velocity (vertical) direction.

With this knowledge, let's get back to the contents of the **Batch Tools** sub-menu:

- **Auto-apply key crossfades:** Creates crossfades between all selected Zones whose key ranges overlap to some extent. Active crossfades will be indicated with a shaded area between Zones; if this makes your Zone grid look too cluttered, try zooming in or switching into List View.



You can manually create crossfades by [Ctrl]-clicking and dragging the left or right border of a Zone.

- **Auto-apply velocity crossfades:** Creates crossfades between all selected Zones whose velocity ranges overlap to some extent.
- **Remove key crossfades:** Removes all key range crossfades from the selected Zones, if any, which reverts them to normal overlapped Zones.
- **Remove velocity crossfades:** Removes all velocity range crossfades from the selected Zones, if any.
- **Move root keys to lower border:** Moves the root key of each selected Zone to the lowest note in the key range.
- **Move root keys to center:** Moves the root key of each selected Zone to the center of the Zone's key range.
- **Move root keys to upper border:** Moves the root key of each selected Zone to the highest note in the key range.

## Wave Editor

In the previous chapters of this manual, we explained how you can use Kontakt to turn Sample files on your hard disk into playable Instruments. Building Zones, Groups and Instruments out of ready-made Samples is fine by itself, but if you want to really get into creative sound design, you'll sooner or later want a tool that lets you work directly on the waveform of your audio material. As you might have guessed already, the Wave Editor is this tool. Let's have a look at what you can do with it:

- **View and audition Samples** This sounds trivial, but it's sometimes helpful to listen to a Sample in its "raw" form instead of playing it via the keyboard right away. Also, there are some problems that can be hard to spot by listening alone, such as DC bias, inaccurate Sample starts, or excessively long silence at the end of your Samples; such issues are easy to notice when you're looking at a graphic representation of your waveform.
  - **Create and edit loops** . Ever since digital sampling became feasible, sound creators have used looping as a means to render the maximum playable note length independent from the actual sample length. In the days of sampling libraries that routinely exceed the 10 GB mark, this might not be the predominant reason for looping Samples anymore; Kontakt's looping facilities go far beyond the traditional concepts, though, and open up a whole range of creative sound design applications.
  - **Slice Zones:** Slicing is a method that lets you deconstruct drum and percussion loops or musical phrases into their rhythmic "atoms" and trigger these either from the outside or using an internal sequencer. This makes it possible to change the tempo of a drum loop or phrase without the sonic artifacts associated with conventional time-stretching algorithms. It also allows you to reconstruct your loops into entirely new patterns and process their elements separately. As slicing your Zones provides Kontakt with information about their rhythmic structure, you can also align most selection and processing operations to the rhythm pattern by making them snap to Slice markers.
  - **Create and edit Zone Envelopes:** Just like you can use envelope generators as a source for parameter modulation on the Group level, Kontakt also provides envelopes that operate on separate Zones. The most striking aspect of Zone Envelopes, apart from the added flexibility, is that you can edit them right on top of the Sample waveform; this makes it possible to create precise automation curves in perfect sync to your audio material.
  - **Perform destructive Sample editing:** Kontakt offers a range of operations that modify your Samples permanently on the hard disk; this is useful for editing tasks that prepare your Samples for smooth operation within Kontakt, such as clean editing of start and end positions, normalizing, fades, or removal of DC bias.
- To open the Wave Editor, click the **Wave Editor** button at the top, just below the Instrument Header.

Usually you'll want to open the Mapping Editor along with it, as the Wave Editor always displays the content of the currently selected Zone; this way, you can easily switch between the Samples in your Instrument by selecting Zones in the Mapping Editor.

Double-clicking a Zone in the Mapping Editor will open the Wave Editor with this Zone right away.

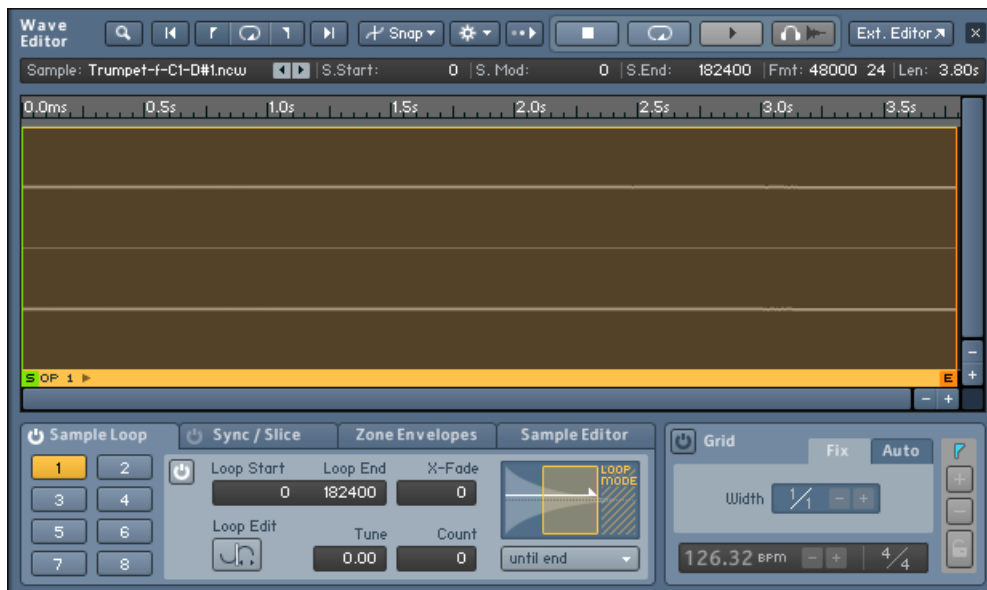

The Wave Editor panel. In its lower half, the Sample Loop tab has been selected, which lets you create and edit loop regions.

The Wave Editor's interface panel is divided into five sections:

- At its top, a horizontal tool bar provides common utility functions and playback controls.
- Below that, a status bar displays various aspects of your current Zone, such as its start and end positions, in numeric form. These readouts make it possible to edit with sample accuracy.
- The largest space is taken up by the waveform view, which contains the Sample waveform and allows graphical editing of various position-related parameters. At the top of the waveform view, you'll notice a time line that informs you about the currently displayed time region and scale of the display. If you don't see a waveform in this section, select a Zone in the Mapping Editor first.
- At the bottom of the editor, four tabs provide access to function sets, which relate to the various tasks you can perform in the Wave Editor: creating and editing loops, synchronizing sliced Zones to your song tempo, creating and editing Zone Envelopes, and editing your Sample destructively.
- Next to the tab section, a Grid panel allows you to define a number of markers at rhythmically relevant points across your Zone; we'll refer to this process as "slicing". Slicing your drum loops or phrases opens up a range of possibilities for changing their speed and patterns, and can be used to align most editing operations to rhythmical values of your material.

Before we get to the more sophisticated facilities that the Wave Editor has to offer, let's stick to the basics and take a closer look at the utility sections, starting at the top.

## Tool Bar

The topmost row of buttons in the Wave Editor pane provides various navigation functions that affect which part of the Sample is currently being displayed, a set of playback controls, and menus that contain selection options and utility commands.



The Wave Editor Toolbar

From left to right, here's what the elements do:



- **Size** (only visible in external window): If you have opened the Wave Editor within an external window by clicking the arrow next to the **Wave Editor** button at the top of the Rack, this drop-down menu lets you choose between three predefined window sizes.
- **Magnify Tool**: This is a toggle button. When it's activated, clicking and dragging your mouse in the waveform view will open a zoom frame; when you release the button, the area within the selection frame will be horizontally zoomed in so that it fills the entire view. Just clicking somewhere within the waveform view will zoom out again. You can obtain the exact same behavior by holding the Alt key while performing the same mouse actions inside the waveform view.
- **Jump to Zone Start**: When you click this button, the waveform view will jump to the start marker of your Zone (which may or may not coincide with the actual beginning of the Sample data).
- **Jump to Loop Start**: Clicking on this button will center the waveform view on the start point of the currently selected loop region.
- **Zoom on Loop**: Zooms the waveform view so that the currently selected loop region fills the entire view.
- **Jump to Loop End**: This button will center the end point of the currently selected loop region in the waveform view.
- **Jump to Zone End**: When you click this button, the waveform view will jump to the end marker of your Zone.
- **Snap**: This drop-down menu contains three toggle options, which affect whether Kontakt will automatically adjust ("snap") the start and end positions of your loop regions to match certain features of your waveform, which can be helpful in finding inaudible loops and avoid clicking. The loop snap modes apply to the whole instrument. Snap loop to zero crossing will snap the start and end points of your loops to positions at which your waveform crosses the zero line and matches the direction of the respective other point; Snap loop to value crossing will snap start and end points to the nearest position where the waveform value and direction matches the value at the respective other point. You can only choose one of these options, or none; the currently active one is indicated with a small check mark icon next to it. Note that when you choose a snap option, Kontakt won't change your loop right away; you'll have to move both the start and end point of your loop manually in order to make them snap to the selected features. How to do this will be explained in section [Sample Loop Tab](#). Finally, you can select Snap sample start/end to zero crossing. This can be done in addition to the loop options.
- **Command Menu** (the cog icon): This drop-down menu contains utility functions that adjust your loops automatically in various ways; the available operations will be explained below.
- **Stop**: This button stops Sample playback.
- **Loop**: When this toggle button is activated, the **Play** button next to it will play your currently selected loop in repetition. Note that only the section between the start and end points of your loop is played, not the initial portion of the Zone before the loop; therefore, the playback result will be different from what you will hear when you trigger the Zone with a note.
- **Play**: Clicking on this button will either play your Zone once (if the **Loop** button next to it is inactive), or the currently selected loop region (if the **Loop** button is activated).
- **Auto Pre-Listen**: When this button is activated, Kontakt will play any region as soon as you select or change it; depending on which tab is selected, this works with loop regions, Slices, or edit selections.
- **Ext. Editor**: When you click this button, the current Sample will be opened within your favorite external Sample editor. This requires that you have set the External Wave Editor option on the **Handling** tab of the **Options** dialog beforehand. Note that while your external editor is running, Kontakt will freeze and not respond to any input; as soon as you quit your external editor, Kontakt will examine the Sample on your hard disk for changes and reload it if required.



## Command Menu

This drop-down menu appears when you click the menu with the cog icon in the tool bar. It contains various functions that operate on the loops of either your current Zone, or all loops of the currently selected Zones. Note that some options are only visible when you have selected an active loop on the **Sample Loop** tab.

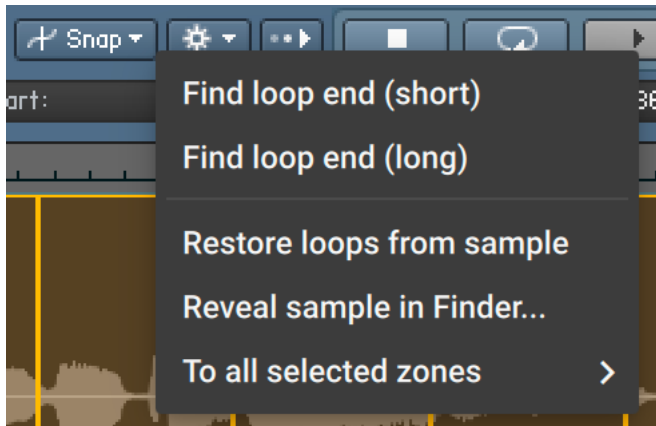

*The Command Menu*

The following commands are available:

- **Find loop end (short)** (only visible when a loop region is selected): Attempts to find a well-working end point for the selected loop region automatically, but will only look for it in the vicinity of your current end point, thereby keeping your loop at roughly the same length.
- **Find loop end (long)** (only visible when a loop is selected): Attempts to determine an optimal end point for the selected loop region. In contrast to the previous entry, this function can increase the length of your loop by a significant amount if the detection algorithm deems a more distant position an optimal candidate for a new end point.
- **Restore loops from sample**: Some audio file formats, such as WAV and AIFF, can optionally carry metadata that specifies one or more loop regions. When you choose this function, Kontakt will look for this data in the Sample file and, if it finds any, use it for creating loops.
- **Reveal sample in Finder/Explorer...**: Opens the folder where the sample is located in either the explorer (Windows) or finder (macOS).

- The following functions can be found below the **To All Selected Zones** sub-menu. As the name suggests, these functions operate on all Zones that you have currently selected in the Mapping Editor, not just the currently displayed one.
  - **Restore loops from samples:** Attempts to retrieve and use loop data from the Samples of all selected Zones. This function works like the similarly named function explained above, but acts upon multiple Zones.
  - **Copy current zone's loop settings:** Copies the loop settings of the currently visible Sample to all selected Zones.
  - **Copy current sample start settings:** Copies the sample start offset of the currently visible sample to all selected Zones.
  - **Copy current start mod settings:** Copies the sample start modulation amount of the currently visible sample to all selected Zones.
  - **Copy current sample end settings:** Copies the sample end offset of the currently visible sample to all selected Zones.
  - **Adjust Loop Starts +/- 1:** This nudges the start points of any loop regions in all selected Zones forward or backward by one sample value. This function is meant for correcting loops that were incorrectly imported; some editors and samplers use different offsets than Kontakt for saving their loop points, which results in loops being off by one or more sample values when you import them.
  - **Adjust Loop Ends +/- 1:** This function works like the previous one, but acts upon the loop end points.
  - **DC Removal:** This function will detect and remove any DC bias from the Samples of all selected Zones. DC bias appears as a constant offset between the sample values and the zero line. While it's inaudible, it can reduce your headroom and cause problems at mixdown. It's also a possible side effect of a few signal processing and re-sampling functions found in sample editors, so it's generally a good idea to execute this function on your Samples once before you proceed with further editing. Note though that it's a destructive function, which will alter the Sample data on your hard disk.

## Status Bar

The status bar is located below the tool bar and contains the filename of the Sample that's assigned to your current Zone, as well as a number of numeric values.

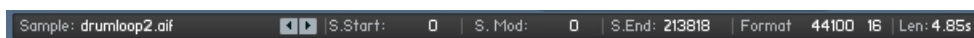

*The status bar of the Wave Editor displays various details of your Sample and your currently selected loop region, if any.*

It serves as a precise position monitor for various editing operations that take place in the waveform view. You can adjust editable values either by clicking on them and moving your mouse up or down, or by double-clicking on them and entering a new value. The status bar consists of the following elements:

- **Sample:** This is the filename (without extension) of the Sample that's assigned to the currently selected Zone. Hovering your mouse over the name will display the full path to this file. Using the left and right arrow buttons at the right side of the field, you can switch to the previous or next Sample file in the same folder as the current one. This will assign a new Sample to the currently selected Zone, so this field works in the same way as the identically named one in the Mapping Editor.

- **S. Start** (Sample Start): The position of your Zone's start marker, indicated in sample values. Moving the start marker will change the position from which the Sample will be played when the respective Zone is being triggered; you can change it either by dragging the vertical green line in the waveform view, or by adjusting this value as described above.
- **S. Mod** (Sample Start Modulation Range): This value indicates the maximum amount by which the Zone start position can be modulated forth and back. For instance, if this range covers two seconds to both sides of the Start position, modulation assignments can change the Start position by two seconds at most. The modulation range is indicated graphically in the waveform view with a green line at the top, which extends horizontally to both sides of the Zone start marker to the earliest and latest start position attainable through modulation. You can change this value by clicking on it and dragging your mouse up or down.
- **S. End** (Sample End): The position of your Zone's end marker. All playback will stop at this position, and any material beyond the marker will be ignored. You can change this position either by dragging the vertical red line in the waveform view, or by adjusting this value as described above.
- **Format**: This readout indicates the sampling rate and bit depth at which your Sample was recorded. It's not adjustable.
- **Len** (Length): The total length of your Sample. This value is not adjustable.

## Waveform View

The central element of the Wave Editor is the waveform view in the middle of the panel. It displays a navigable, visual representation of your Sample and allows you to perform a number of editing functions in a direct and intuitive graphical way.

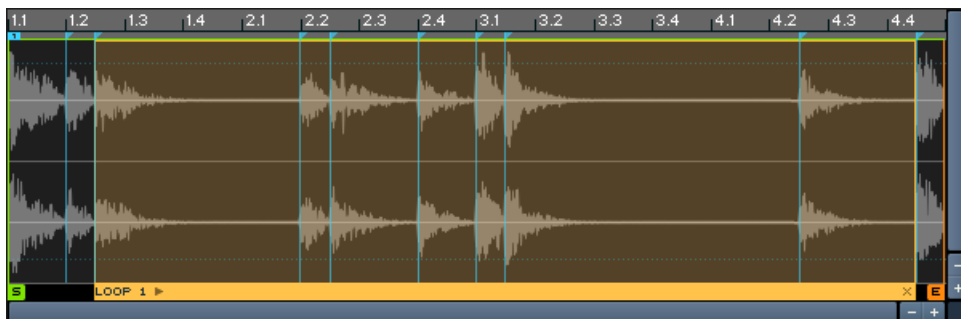

*The Waveform View*

If you don't see a waveform when you open the Wave Editor, remember that you first need to select a Zone in the Mapping Editor. It's a good idea to keep the Mapping Editor open as well when you're using the Wave Editor, as this arrangement allows you to quickly switch between the Zones in your Instrument. When a Zone is selected, the waveform view will display the waveform of the assigned Sample, with each audio channel being drawn on a separate zero line. The time line at the top of the view indicates which portion of the Sample is currently being shown, and allows you to estimate the length of loops, Slices, and selections visually. In addition to the waveforms, the waveform view contains a variable number of additional items. Note that some of these, such as the loop regions, envelopes, or Slice markers, pertain to features which will be explained in detail later in this chapter.

- The start position of your Zone is indicated with a green vertical line that ends in a flag at the bottom. Unless the Zone start position is being modulated, any playback of the current Zone will always start at this marker, and the Sample portion to the left of the marker is discarded. To change the position of the Zone marker, click its green flag at the bottom and drag it horizontally, or adjust the **S. Start** value in the status bar as explained in the previous section.

- The end position of your Zone is indicated with a red vertical line. It marks the position in your Sample where all playback will stop. Apart from that, you can handle it in the same way as the start marker.
- The range in which your Zone start position can be modulated back and forth is indicated with a horizontal green line above the Zone start marker. You can adjust this range by clicking on its numeric value in the status bar and dragging your mouse vertically.
- When the **Sample Loop** tab at the bottom of the editor is selected, loop regions will be highlighted, with the currently selected region being indicated with a brighter color and a small status bar at its bottom. Loop crossfades will show up as diagonal lines at the beginning of a loop section. When one of the other tabs is selected, the borders of your loop regions will be shown as vertical lines, with a horizontal, dashed line in between.
- When the Grid is activated, Slice markers will appear as vertical lines across your waveform. The first marker, which allows you to adjust the Grid offset, is marked with a small "1" at its top.
- If your Grid is in Auto mode, thereby aligning the Slice markers to peaks in your Sample, the threshold above which a peak will create a Slice marker is shown graphically with horizontal lines across the view.
- When the **Zone Envelope** tab is selected, the currently selected Zone Envelope will be displayed as a curve on top of the waveform. If your Zone Envelope contains a loop region, it will be highlighted. A vertical line indicates where clipboard contents will be inserted when you use the Paste function.
- When you switch to the **Sample Editor** tab, a vertical line indicates where clipboard contents will be inserted when you use the Paste function.
- The Sync / Slice, Zone Envelopes, and Sample Editor tabs allow you to select contiguous regions of your Sample for editing; these selected regions will be highlighted.

Just like in other editors, you can move the portion of the content that's currently being displayed by clicking and dragging the horizontal and vertical scroll bars. The horizontal scroll bar allows you to move to a different time position of the Sample. The vertical scroll bar shifts the waveform of each channel up or down within its view region; when you have zoomed in vertically, this scroll bar allows you to view the signal at different parts of the level range.

There are different ways to zoom in and out of your waveform. Firstly, there's a noteworthy difference between zooming horizontally and vertically. Horizontal zooming works in the same way as in other editors: zooming in magnifies a region of the content (in this case, a specific time range) so that it fills up the view, thereby displaying a greater level of detail, zooming out fits more content into the view. Vertical zooms in the waveform view, on the other hand, will always keep the zero line of each channel at its respective position, thus magnifying only the amplitude of each waveform. This makes it possible to see level changes that are too small to be noticed at a normal zoom level; by zooming in vertically, you can make out small sonic details, such as release trails, in regions that look like plain silence on a lower zoom level.

You can zoom in and out horizontally or vertically one level at a time by clicking the "+" and "-" buttons next to the scroll bars. Whenever you use this method to zoom vertically, the zero lines of each channel will be re-centered in their respective regions of the view. An alternative that's often more convenient is to hold the Alt key while clicking and dragging your mouse in the view; this opens a "rubber band" selection frame. Once you release the mouse, the selected region will be zoomed in so it fills the whole view. To zoom out again, just click somewhere in the view. This method allows you to quickly and intuitively get a detail view of a specific region of your Sample. Enabling the button marked with a magnifying glass in the tool bar has the same effect as holding Alt.

## Grid Panel

The Grid settings affect most other operations in the Wave Editor, so we'll describe this feature before we get to the function tabs. You can find all settings that pertain to the Grid on the panel in the lower right corner of the Wave Editor. When the Grid is inactive, this panel will be shaded.

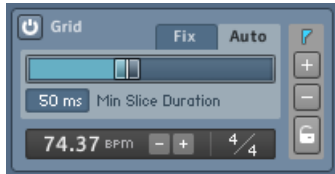

*The Grid Panel*

In a nutshell, whenever you're working with Samples that contain rhythmic material or musical phrases, the Grid allows you to put a marker on every single hit or note that occurs within your Sample, thus splitting it up into a number of musically significant regions — we will refer to these regions as "Slices" from now on. Preparing your material in this way ("slicing") has lots of advantages:

- By aligning loop regions with Slice markers, you can instantly create clean Sample loops that stay in perfect tempo.
- Using the functions on the **Sync / Slice** tab, you can adapt your drum loop or phrase to your song tempo in various ways.
- The mapping features of the **Sync / Slice** tab allow you to turn Slices into separate Zones, which makes it possible to trigger them separately; this way, you can instantly create a playable "drum kit" from any drum loop, and construct entirely new patterns out of its elements.
- When you're working with Zone Envelopes, you can make their breakpoints snap to Slice markers. This way, it's easy to create rhythmical modulation curves.
- When you've selected the **Sample Editor** tab, the region selection for destructive operations will snap to Slice markers as well, which lets you perform operations like removing, exchanging, or reversing Slices in isolation very quickly.

It's almost always a good idea to activate and adjust the Grid panel first before doing any further editing on rhythmic material. To activate the Grid, click the "power" button in the upper left corner of the Grid panel. The panel will light up, and a number of vertical markers will appear across your waveform view — if you can't see them, try zooming out horizontally. Each of these markers indicates the start of a Slice (and the end of the preceding one). You can always move these markers around by clicking on the small arrows at their top and dragging them horizontally, but in a lot of cases, you won't have to. That's because the Grid offers two modes that take care of the correct marker placement for you, namely Fix and Auto. You can switch between these modes by selecting one of the tabs in the Grid panel.

### Fix Mode

The **Fix** mode is intended for slicing material that has a very precise timing; it's less ideally suited for sloppily played acoustic drums. Also, it helps to have your drum loop or phrase edited cleanly when you're planning to use the Fix mode, with the first beat being exactly at the beginning of the Sample, and no silence after the last beat; this is not a requirement, though. When you activate the Grid on a Zone for the first time, it's in Fix mode by default; if you're currently in Auto mode, you can switch to the Fix mode by clicking on the **Fix** tab of the Grid panel.

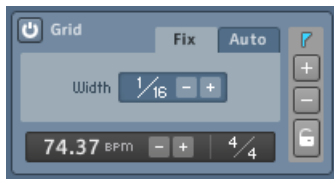

*The Grid Panel in Fix mode*

The idea behind the **Fix** mode is that your Sample will be split up into Slices of equal length, which is determined by the tempo of the loop, its time signature, and a selectable note value.

To achieve a proper slicing, Kontakt first needs to know the native tempo of your Sample. It tries to guess this by looking at its total length and assuming that it's a whole number of measures, played in a 4/4 meter. The resulting tempo is displayed in BPM at the bottom of the Grid panel. Note that this guess will only have a chance of success if your Zone has been cleanly edited, with the first hit or note being exactly at the beginning, and no excess space behind the last one. If you've made sure that this is the case, but the displayed tempo value is still incorrect, there can be two reasons for this:

First, your drum loop or phrase could be in a different meter than 4/4. This is easy to correct: next to the tempo readout, you'll notice a Time Signature value. By clicking on either its numerator or its denominator and dragging your mouse up or down, you can specify a different meter.

If the Time Signature value matches the meter of your loop, but the tempo is still incorrect, Kontakt has estimated the number of bars in your Sample incorrectly. You can validate this by switching to the **Sync / Slice** tab and checking the value of the Zone Length field. For instance, if your Zone consists of one bar at a tempo of 50 BPM, Kontakt might misinterpret it as two bars at 100 BPM. In such cases, the detected tempo will always be a multiple of the actual tempo, or vice versa. You can correct this by halving or doubling the tempo value with the "-" and "+" buttons next to it, respectively, until the correct tempo is indicated. Note that this will change the length as indicated in the Zone Length field on the **Sync / Slice** tab as well; the tempo and (musical) length values are invariably tied to each other.

Of course, if you already know the tempo of your Sample, you can skip all this and just enter the correct tempo value after double-clicking on the tempo value. Alternatively, click the time line and drag your mouse horizontally; this will stretch or compress your Grid until it matches the tempo of your Sample. Provided that your Sample start is cleanly edited, adjusting the tempo directly will give you a perfectly set up Grid right away. If there's any silence at the beginning, the Slice makers will all land slightly before the actual hits; you can compensate this by moving the first Slice marker, labeled "1" at its top, which will move all following Slice markers along, thereby adding a time offset to your Grid.

Once the tempo of your Sample is set to the correct value and you have compensated any possible time offset, you'll notice that the Slice markers in the waveform view split your Sample into 16th notes. That's because the Grid uses the length of one 1/16th note as the default width for Slices. You can change this value by adjusting the control labeled Width in the middle of the **Fix** tab. You can change both the numerator and the denominator of the displayed note value by clicking on it and dragging your mouse vertically; also, clicking on the -/+ buttons next to the note value will halve or double the denominator, thereby increasing or decreasing the size of your Slices.



The Slice width directly affects the usefulness and quality of later tempo adaptations, either via the Beat Machine or by triggering the Zones from the outside. For instance, if your loop contains a constant 16th hi-hat groove and is sliced up into 8th notes, two hi-hat hits will end up in each Slice, with the duration between them remaining constant. This would create a shuffle effect with increasing tempo. While this trick can be useful in some cases, it's usually a better idea to use the smallest rhythmical division that occurs in your drum loop as the Slice width: 1/8 for a straight heavy rock beat, 1/16 for a more delicate funk groove, 1/12 for a ternary shuffle, and so on.

Once you're done with all required adjustments and made sure that the Slice markers are well-aligned with your beat, you might want to remove or add Slice markers to accommodate pauses or additional ghost notes outside of the Grid, or manually correct the position of some Slice markers. These actions will be described after the next section.

### Auto Mode

The **Fix** mode of the Grid works well for exact and predictable beats or phrases, possibly of an electronic origin, that follow a fixed pattern in tempo and articulation. It's less practical with irregular beats or loops that were recorded live and played by a drummer with less than perfect timing: in such cases, most Slice markers that were placed in **Fix** mode will land slightly before or after the hits they were meant for, and would need careful manual tweaking to be corrected. This makes the **Auto** mode the better choice for such material. You can switch over to this mode by clicking on the **Auto** tab at the top of the Grid panel.

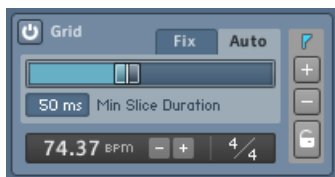

*The Grid Panel in Auto Mode*

In Auto mode, Kontakt detects transients in the waveform of your Sample and creates Slice markers at these positions. For instance, each bass drum and snare hit in a typical rock groove will be clearly visible as a level peak in its waveform; intermediate hi-hat hits will be visible as smaller peaks. By using the attack phases of these peaks as Slice positions, Kontakt can split these elements into Slices automatically. All you have to do is telling Kontakt the level above which a transient shall be considered for slicing; this level threshold is the most important parameter of the Auto mode.

When you switch the Grid into Auto mode, you'll notice two dotted, horizontal lines that appear at the top and bottom of your waveform view. By moving the horizontal slider on the **Auto** tab, these lines will change their position; they indicate the peak detection threshold graphically. Any peaks in your waveform that cross these lines will result in a Slice marker being placed at their respective position. As an example, reconsider the straight rock groove mentioned above: adjusting the threshold so that only the strong bass drum and snare hits cross the threshold will create large Slices, possibly at the length of 1/4 and 1/8 notes. Slowly lowering the threshold will gradually add more Slices, until all hi-hat hits and ghost notes will be marked separately.



When you're using this function frequently, you'll sooner or later encounter a drum loop where no threshold setting seems to work just right: on higher settings, hits that you'd like to be included will be ignored, while lower settings will add too many unwanted bits to the Grid. There are two ways to deal with this problem: if a low threshold tends to add lots of very small slices (for instance, on snare flams), try increasing the parameter labeled Min Slice Duration below the threshold fader. This will ignore all slices that would be shorter than the specified length. If this does not work, try to find a compromise threshold that covers most of the hits you'd like to be included, and then add or remove Slices manually as needed. This process will be explained in the next section.

Note that even if you're using the Grid in Auto mode, Kontakt still needs to know the tempo of your Sample if you want to use one of the features for automatic synchronization. Therefore, the tempo control is still visible at the bottom of the Grid panel in Auto mode and might need manual adjustment as described in the previous section. In contrast to the Fix mode, though, it won't affect the position of your Slice markers; it's only important if you use the Beat Machine or Time Machine to adapt your Sample to a new tempo.

### Editing Slices Manually

You can manually modify or delete any Slice, including those that were generated by Kontakt, and add new Slice markers to your Sample. This allows you to fine-tune automatically generated Slices, or manually slice material that's not suitable for being processed automatically.

Note that whenever you move an existing Slice or add a new one, it will be automatically locked. While Slice markers that were created via the **Fix** or **Auto** mode will change their positions or disappear when you adjust the tempo or switch the Grid mode, locked markers will always remain at their absolute position within the Sample until you change their position or remove them manually. Locked markers will appear as gray vertical lines in the waveform view.

There are several ways in which you can engage in the slicing process:

- To move an existing Slice, click the small triangle at the top of its marker in the waveform view, and drag it horizontally. If you need to change it with more precision, try zooming in on the waveform. The first Slice marker in your Sample, indicated with a small "1" flag at its top, is special; when you move it, all following markers will move along by the same amount. This allows you to compensate silence at the beginning of your Sample.
- To remove a Slice from your Sample, enable the "-" button on the right side of the Grid panel, then click the small triangle icons on top of the Slice markers that you'd like to remove from your Sample. Remember to disable the "-" button when you're finished to avoid accidental deletions. Alternatively, you can remove a Slice marker by right-clicking on the triangle at its top.
- To add a new marker to your Sample, activate the "+" button on the right side of the Grid panel, then click in the waveform view wherever you'd like the new marker to be located. When you're done, remember to deactivate the "+" button again. Alternatively, you can right-click anywhere in the narrow strip below the time line in order to create a marker at that position.
- Finally, if you want to toggle the "locked" status of a Slice marker manually, activate the lock icon on the right side of the Grid panel, then click the small triangle on top of the marker(s) that you'd like to lock or unlock. To lock all slices at once, Alt-click the lock icon. Remember that any unlocked Slice markers will be changed when you adjust the tempo or switch the Grid mode.



## Sample Loop Tab

The functionality of the Wave Editor is split across four tabs at the bottom of its panel. Any tab that you select changes the behavior of the wave editor and the details that are being shown in the waveform view to a certain amount; for instance, when you switch to the **Sample Loop** tab, Kontakt will highlight all loop regions in your Sample; when you change to the **Zone Envelopes** tab, loop regions will merely be hinted at with vertical amber lines, but any selected Zone Envelope will appear as an orange curve on top of the waveform. In this section, we'll take a look at the **Sample Loop** tab.

First of all, a little semantics. In the context of sampling, the term "loop" is used for two different concepts, which are related, but should be distinguished anyway for sake of clarity:

- Technically, a loop is a contiguous region of a Sample that will be played back repeatedly; in a traditional forward loop, the playback position will jump to the start of this region whenever it reaches its end. In Kontakt, loops can be played forward and backward alternately, or played only a specific number of times before playback will proceed as usual. When we refer to loops in the context of this section, we're talking about this technical concept.
- A more colloquial use of the term is to describe Samples that contain musical phrases (as opposed to single notes). Often, these Samples are pre-produced drum or percussion phrases ("drum loops"), which makes them useful as building blocks for rhythm parts. As the name implies, these Samples are usually meant for being played in repetition in order to fill the required number of measures. This can be done by looping them in the sampler as described above; however, this is not a prerequisite. Many people prefer to trigger them inside their sequencer on each downbeat instead; this method has the added benefit of avoiding tempo drifts that can occur over time when a loop region doesn't match the length of a measure exactly.

Sample loops were common in the heyday of hardware samplers, when both disk space and sample RAM were sparse. This limitation made it all but impractical to capture notes of an instrument like a piano, which can have a natural decay time in the order of a minute, in their entirety. Instead, it was reasoned that the most critical part of an instrument sound is its attack phase; after that, most sustained instruments quickly settle to a predominantly periodic waveform of some sort. By using sample loops to keep these periodic parts sounding during the sustain phase, thereby artificially "stretching" the sound beyond the length of the actual sample data, sample creators overcame the space limitations.

With the advent of software sampling and hard disk streaming, this application of loops became a little less important. They're still being used in this way, but their predominant appeal nowadays is creative sound design. As you might guess, loops in Kontakt are equally well-suited for both approaches; let's see how they work. To create and edit loops, first click the **Sample Loop** tab in the Wave Editor.

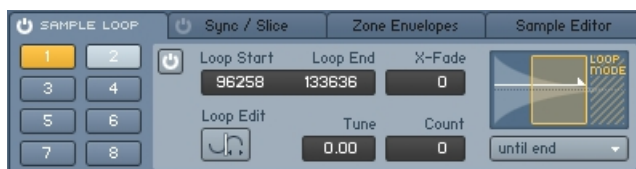

The Sample Loop tab of the Wave Editor is split into a number of loop selection buttons, and a parameter view for the currently selected loop region.

You'll notice a small "power button" icon to the left of the tab title. Clicking on this icon will globally activate or deactivate all loops of your Sample. When your Zone contains any active loop region, this button will be lit up.

Kontakt allows you to define up to eight different loop regions per Zone. These “slots” are accessible via eight buttons, which are arranged in a 2x4 grid below the tab. When you start with an unlooped Zone, none of these buttons will be highlighted, which indicates that there are currently no active loop regions. Each selection button can take up one of 3 colors:

- **Non-highlighted (dark blue):** The respective loop region has either not been defined yet, or has been temporarily deactivated.
- **Yellow:** The respective loop region is active and currently selected for editing. The region will also be highlighted with a bright amber color in the waveform view. Only one loop region can be selected for editing at any time.
- **Light blue:** The respective loop region is active, but not currently selected.

Clicking on one of these buttons will select the respective loop region for editing; if it's not active or has not been defined yet, it will be activated in the process. When you select a loop region, Kontakt will display its parameters within the edit panel next to the selection buttons, and highlight the region in the waveform view. You can instantly create a loop region by right-clicking into the waveform view and dragging your mouse horizontally. This will replace your currently selected loop region, or, if none is selected, define the first one. You can change the start and end positions of a loop region graphically by clicking on its left or right border, respectively, and dragging it horizontally. Clicking inside a region and dragging it allows you to move loop regions without changing their size. You can view and change these and all other parameters of a loop region numerically within the edit panel.

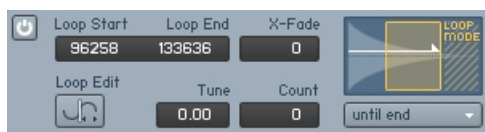

*The detail view allows you to adjust the start and end positions of your loop regions numerically with sample value accuracy.*

To change any value, either click it and move your mouse vertically, or double-click it and enter a new value. Let's have a look at each parameter of the edit panel:

**Power Button:** Indicates whether the current loop region is active. When you select a loop region for editing, it will automatically be activated. To disable (and de-select) a region, click this button. Note that this applies to the power button in the edit panel of the selected loop region; the power button next to the tab title will globally activate or deactivate all loop regions.

**Loop Start:** The start position of the loop region within your Sample, displayed in sample values.

**Loop End:** The end position of the loop region within your Sample, displayed in sample values.

**X-Fade:** To mask imperfect loop points, Kontakt can fade the end of the loop region into its beginning. This value adjusts the length of this crossfade in milliseconds. Kontakt will indicate a loop crossfade in the waveform view with a diagonal line on the left side of a loop region.

**Loop Edit:** When activated, Kontakt will switch the waveform view to an alternate display mode that allows you to adjust your loop points in a very intuitive way.

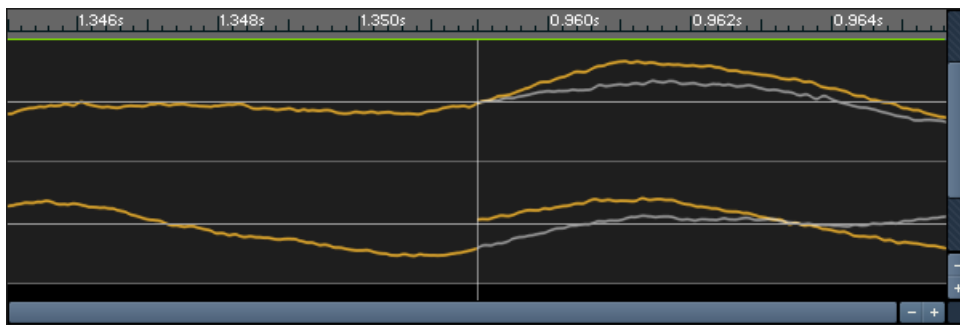

*The Loop Edit View*

The Loop Edit view is split vertically; the left side will show the waveform just before the loop end point, the right side will show the waveform just after the loop start point. In other words, the boundary in the center depicts the transition that will occur at the loop point. In addition, the original progression of the waveform after the end point is shown in a dim gray in the right part of the view, which allows you to assess how close the transition matches the unlooped waveform. You can move your loop start and end by clicking in the right or left part of the view, respectively, and dragging the mouse horizontally. Alternatively, you can adjust the numerical values within the edit panel in the usual way. While you change the positions, observe the transition in the center of the view; the more it looks like a continuous waveform, the cleaner your loop will turn out to be. To return to the normal waveform view, just click the **Loop Edit** button again.

**Tune:** This control allows you to change the pitch of Sample loops independently from the rest of your Zone. Note that the detuning will affect all playback passes after the first loop jump; in other words, Kontakt will play the region at its normal pitch once until the playback position reaches the end marker of the loop, then the specified pitch will come into effect for the duration of the loop.

**Count:** This value specifies how many times the loop region will be repeated before Kontakt proceeds to play the rest of the Sample. A value of zero will loop the region indefinitely, which means that playback will never reach any following Sample material and loop regions.

**Loop Mode:** This drop-down menu lets you choose between several different loop characteristics. In addition to the displayed entry, the selected behavior is depicted with an illustration above the menu. Kontakt provides the following loop behaviors:

- **Until End:** Kontakt will play the loop in a forward direction. The loop will keep playing during your amplitude envelope's release phase, if any.
- **Until End <->:** Kontakt will play the loop in alternating forward and backward directions ("ping-pong loop"). The loop will keep playing during the release phase of your sound.
- **Until Release:** Kontakt will play the loop in a forward direction as long as the key is being held. When it's released, it will resume normal playback of the Sample, starting from the current playback position.
- **Until Release <->:** Like **Until Release**, but with an alternating forward and backward playback direction during the loop.
- **One Shot:** If the first loop region of your Sample is set to this mode, Kontakt will ignore all other active loop regions and play the Sample in its entirety when it's triggered, without stopping at note-off events. This is useful for drum samples that should always play to their end, regardless of the actual trigger note length. Note that this works only if you're not using a volume envelope on your Group; otherwise, the release phase will still fade the Zone out as soon as the key is released.

If the Grid is active, all changes to the start and end points, whether they take place graphically within the waveform view or numerically within the edit panel, will snap to the nearest Slice marker; this makes creating exact loop regions within rhythmic material very easy. For a thorough description of the Grid feature, refer to the previous section of this chapter.

## Sync / Slice Tab

In the section about the Grid panel, we mentioned that slicing your drum or percussion loop with the Grid allows you to synchronize its playback speed to your song tempo in a number of different ways, or map the resulting Slices to your keyboard, which lets you trigger the elements of a drum loop or a phrase at your own tempo and in your own pattern. The launch pad for all these features is the **Sync / Slice** tab in the lower part of the Wave Editor. Note that an active Grid that's adjusted to match your Sample is a prerequisite for most of these functions to work; if you want to synchronize or rearrange any rhythmic material, you should therefore always set up the Grid first, then proceed to use the functions on the **Sync / Slice** tab. Section [Grid Panel \[159\]](#) of this chapter explains how to activate and adjust the Grid.

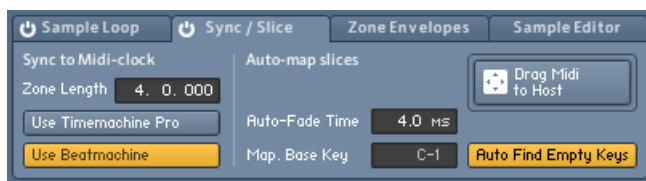

The Sync / Slice tab

The **Sync / Slice** tab provides four different approaches to make your Sample independent from its original tempo or pattern: you can feed your slices to the Beat Machine, time-stretch your Sample with the Time Machine, or map your Slices to the keyboard in a manual or automated fashion. Let's have a look at the advantages and peculiarities of each approach.

### Using the Beat Machine

The Beat Machine, which is one of the playback modes provided by Kontakt's Source Module, plays all Slices of your Zone in succession via an internal sequencer. This retains the original pattern of your drum loop or phrase, but allows you to adapt it to your song's tempo, or freely change the playback pitch of the Slices. To use this feature, make sure your Grid is correctly set up, and enable the **Use Beatmachine** button on the **Sync / Slice** tab. Depending on the contents of the Group to which your current Zone belongs, one of two things will happen:

- If the current Zone is the only one in your Group, Kontakt will switch the Source Module of this Group into Beat Machine mode.
- If there are any other Zones in your Group, Kontakt will move the current Zone into its own Group first and then switch that Group's Source Module into Beat Machine mode. This reassignment is necessary to avoid disrupting the playback of other Zones which cannot be triggered correctly by the Beat Machine.

Once the Source Module that plays your Zone is in Beat Machine mode, any key to which the Zone is assigned will trigger the tempo-synchronized playback of all Slices in succession. When you look at the **Speed** knob of your Group's Source Module, you will notice that it displays the keyword **Zone** instead of the usual numeric value. This indicates that it uses the Zone Length value (as displayed on the left side of the **Sync / Slice** tab) to determine at which speed it has to play the Slices so that the phrase will span the same length at your song tempo. This is the same mechanism that allows you to select a note value from the drop-down menu of any time-related control in order to synchronize it, and in fact, the special **Zone** keyword appears among the usual note values in the drop-down menu of the Speed control if you use the Beat Machine via the **Sync / Slice** tab. Of course, nothing prevents you from selecting a different note value from the drop-down menu, or selecting the Default entry in order to adjust the playback speed independently from your tempo. You can always return to synchronized mode by selecting Zone again.

Note that all changes to the slicing of your Sample will be immediately picked up by the Beat Machine, which lets you hear any modifications instantly. For example, you might notice during playback that some ghost notes are not properly marked in your Sample and are thus being played back with incorrect timing. Just add the respective Slice markers, as explained within the Grid section of this chapter – the Beat Machine will adopt your changes right away, even during playback.

### Using the Time Machine

As an alternative to the Beat Machine, Kontakt can also use the more conventional time-stretching algorithms of the Time Machine mode to sync your Sample to the tempo of your song. While using the Beat Machine or one of the Slice mapping features explained below is usually the better choice for percussive material, the Time Machine can be very useful for tonal phrases.

As the Time Machine treats your Sample as one contiguous region with no regard to Slices, you don't necessarily need to have the Grid activated in order to use this feature. However, Kontakt still needs to know the length (and therefore, the tempo) of your Sample in order to determine how far it has to be stretched or compressed in time to match your current tempo. Therefore, you need to specify the correct (rhythmical) length of your Zone in the Zone Length field of the **Sync / Slice** tab. If you don't know the length, you can alternatively activate the Grid and specify the tempo of your Sample instead. Kontakt needs to know only one of these values, as the respective other one can be derived. Note that specifying the Zone Length value explicitly will only change the tempo correctly if the end marker of your Zone coincides with the actual Sample end; otherwise, it will change the end marker position to match the length that you entered. In such cases, you should therefore adjust the tempo in the Grid panel instead.

Once the Zone Length field displays the correct length, enable the **Use Timemachine Pro** button on the left side of the **Sync / Slice** tab. If your Zone is not the only one in its Group, Kontakt will move it into a new Group first to avoid disrupting the playback of other Zones. The Source Module of the Group that contains your Zone will then be put into Time Machine mode.

Just like the Beat Machine, the Time Machine will have its Speed control set to the special Zone value by default when you're using it via the **Sync / Slice** tab. This means that your Sample will be played back at your host or Master Editor tempo right away when you trigger it. The meaning of the Zone keyword and how you can override it to freely adjust the playback speed is explained in the previous section of this chapter.

### Mapping Slices Manually

Once you have placed Slice markers across your Sample via the Grid, you might want to trigger these Slices directly with your keyboard or from within your sequencer. The manual mapping feature of the **Sync / Slice** tab lets you do just that.

Provided that you have correctly set up the Grid for your Sample and selected the **Sync / Slice** tab, you can select Slices that you want to map to your keyboard simply by clicking between two Slice markers in the waveform view. Kontakt will highlight any selected Slice in blue. To add more Slices to your selection, either hold the [Ctrl] key ([Cmd] on Mac OS X) and click further Slices one at a time, or hold the [Shift] key and click a second Slice to select all Slices in between. For instance, if you want to map all Slices of your Sample to keys, click the first one, then hold [Shift] and click the last one; this will select all Slices and highlight the entire Sample.

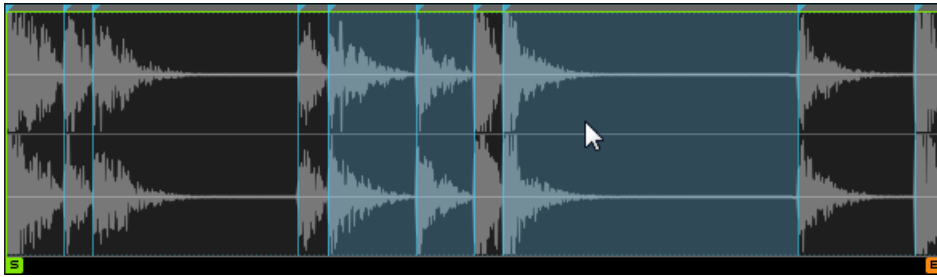

*Selecting Slices*

Once you're happy with your Slice selection, make sure the Mapping Editor is visible above the Wave Editor. Now, click one of the selected Slices, and drag it over into the Zone grid of the Mapping Editor; all other selected Slices will move along. You'll notice that while keeping your mouse button pressed, Kontakt will highlight a range of keys in the Zone grid, starting from the key below your mouse pointer. This allows you to position the Slices you've selected on the keyboard. The process works exactly as if you're dragging a number of Samples from the Side pane into the Mapping Editor – the horizontal mouse position determines the key at which Kontakt will begin to map the Slices, while the vertical mouse position within the Zone grid determines the number of adjacent keys each Slice will be assigned to.

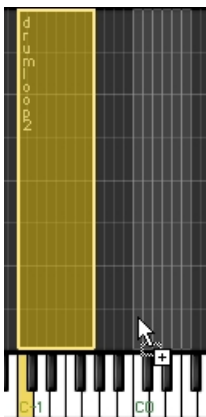

*While you keep your mouse button depressed, Kontakt will indicate where it would place the new Zones on the keyboard.*

If you agree with the displayed assignment pattern, release your mouse button. Kontakt will now create a new Zone for each Slice in your selection, and place all Zones in succession in the order in which they appear in your Sample. Each of the new Zones will reference the original Sample from which it was created, with its Sample start and end markers set to the boundaries of the original Slice. You can now trigger these Zones from your keyboard or within your sequencer, create new patterns with them, or adjust the playback or effect parameters of each Zone separately via Zone Envelopes.

## Mapping Slices Automatically

While mapping your Slices manually in the way described above works well if you want to place only specific Slices or a range of Slices onto keys, the more frequent case will probably be that you'd like to put all Slices on adjacent keys and then trigger them from within your sequencer. Of course, you can do this manually as well; there's a better way, though. The auto mapping feature of the **Sync / Slice** tab allows you to automatically map all Slices of your Sample to adjacent keys. What's more important, it can generate a MIDI sequence for you that, when placed in your sequencer, will trigger all Slices in exactly the same pattern as they occur in your Sample. As your sequencer will obviously play MIDI sequences at the song tempo, the pattern will always be in sync, thereby replicating the functionality of the Beat Machine. The feature leaves more room for creativity, though: once you have imported the MIDI sequence into your arrangement, you can go ahead and make modifications to this pattern. Of course, you can also discard it altogether and build your own patterns from scratch, thereby reassembling your drum loop or phrase in an infinite number of ways.

Before the auto mapping can take place, you may need to adjust some parameters first that affect where the new Zones will be placed and how Kontakt will handle the Zone creation process. You can find these parameters in the middle and on the right side of the **Sync / Slice** tab.

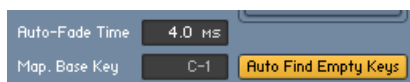

*The Auto Mapping parameters*

- **Auto-Fade Time:** Kontakt can optionally create volume fade envelopes for each Zone that it creates from your Slices. When you set this parameter to a value other than zero, each new Zone will contain a volume Zone Envelope which fades the respective Slice in and out; the specified value determines the fade-out time, the fade-in time will be shorter than that. Creating auto-fades for your Slices can give smoother results when you change the playback speed of the pattern. The specifics of how Zone Envelopes work will be explained in the next section of this chapter.
- **Mapping Base Key:** This is the first key at which Kontakt will start mapping the Slices.
- **Auto Find Empty Keys:** If activated, Kontakt will leave out any keys that trigger existing Zones when it maps Slices to the keyboard. This avoids mapping Slices to the same keys as other Zones.

After adjusting these parameters, you can go ahead and start the auto mapping process. You'll notice a rectangular field labeled Drag'n'Drop MIDI at the right side of the **Sync / Slice** tab. From here, you can "pick up" the MIDI sequence that corresponds to your Slice pattern; just click inside the field and drag its content onto either your desktop (which will create a standard MIDI file) or into the arrangement window of your MIDI sequencer (which will insert the MIDI sequence right into your arrangement). If you're sure you won't need the MIDI file, you can also just click the field instead; this will only create the mapped Zones.

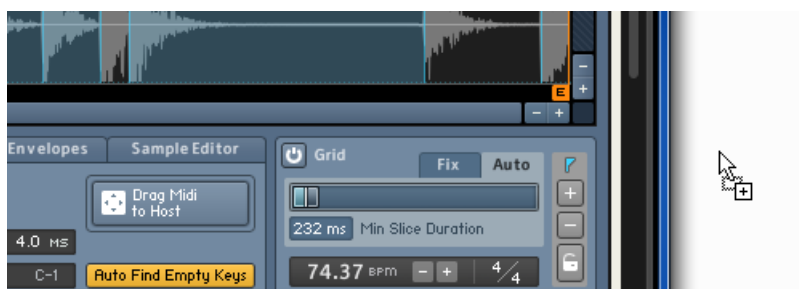

*Using Drag MIDI to Host*



At the same time, Kontakt will create the required Zones, map them to the keyboard, and put them into a new Group. If you've placed the MIDI sequence on the correct track of your arrangement – it has to be sent to the MIDI channel of your current Kontakt Instrument – and play it back, you should hear your drum loop or phrase played back at your song tempo. If you want, you can now proceed with modifying this MIDI sequence. Of course, should you decide to delete the sequence, the generated Slice mapping will stay in place, so you can build your own patterns from scratch as well. To get rid of the mapping, just delete the Group that was created in the process.

## Zone Envelopes

Envelopes are a common source for modulating parameters in synthesizers and samplers; they provide a flexible way to create finely adjustable and repeatable modulation patterns. In Kontakt, envelopes are usually being generated by envelope generators, which act as signal sources for modulation assignments. These can be added to Group-level modules, which means that any conventional envelope affects all Zones in a Group in the same way. There are cases, however, when modulating parameters on a per-Zone basis would be really helpful; Zone Envelopes make this possible. What's more, since they are directly tied to the Sample of the Zone in which they appear, you can edit them on top of the waveform view; this allows you to intuitively create all kinds of modulations in perfect sync with the Sample content.

To create and edit Zone Envelopes, click the **Zone Envelopes** tab at the bottom of the Wave Editor.



From left to right, the Zone Envelopes tab provides selection and delete functions, assignment buttons, edit tools, and utility functions.

## Assigning and Selecting Envelopes

Similarly to normal Group-level modulation assignments, the first step to create a Zone Envelope is to tell Kontakt which parameter you'd like to modulate. For this purpose, the **Zone Envelopes** tab provides three assignment buttons, labeled **Volume**, **Pan**, and **Add**. These are located in the middle of the panel. Each of these buttons creates a new Zone Envelope for a specific parameter and selects it for display; if an envelope for the selected parameter already exists, an info message will appear instead.



The upper two assignment buttons create a Zone Envelope for volume and panorama position, respectively; using the lower button, you can create a Zone Envelope for any Group-level parameter.



The upper two buttons create envelopes for the playback volume and the panorama position, respectively; as these are parameters that you will probably want to modulate frequently, they are provided here for quick access. The third button, labeled **Add:**, allows you to create Zone Envelopes for any parameter that appears on a panel of a Group-level module. Whenever you click the control of such a parameter, the **Add:** button will pick it up and display its name. By clicking on the **Add:** button then, you can create a new Zone Envelope which modulates the chosen parameter. For instance, you might want to modulate the cutoff frequency of a filter that resides in the Group Insert Effects chain of your current Group; just locate the **Cutoff** knob on the filter panel (you may have to double-click the filter module in the chain if you don't see it) and click it – you don't need to move it. The lowest assignment button on the **Zone Envelopes** tab of the Wave Editor should now read Add: Cutoff. When you click this button, a new cutoff envelope will appear as a straight horizontal line within the waveform view.

In theory, you can create a Zone Envelope for every Group-level parameter, all within one Zone. However, Kontakt will only display one of your envelopes in the waveform view at any time. In order to select a Zone Envelope for viewing and editing, click the drop-down menu button on the left side of the **Zone Envelopes** tab, and choose an existing envelope from the menu.

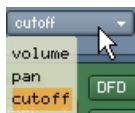

The selection drop-down menu contains all Zone Envelopes of your current Zone. Selecting one will display it in the waveform view.

If you want to get rid of an envelope, first select it for editing via the drop-down menu, then click the **Delete** button below. This will remove the envelope from the list and return the respective parameter to its unmodulated state.

### Adjusting Assignment Parameters

There are a few adjustable parameters that change the way in which the Zone Envelope's shape will affect the modulated parameter. For this purpose, each Zone Envelope that you create will add an entry to the Modulation Router of the module that contains its target parameter. You can jump to the corresponding assignment parameters of a currently selected Zone Envelope by clicking on the Modulation **Quick-Jump** button that's located next to the assignment buttons on the **Zone Envelopes** tab.



The Modulation Router of a Zone Envelope

A Modulation Router entry of a Zone Envelope looks and works exactly like one that belongs to a normal modulation assignment – it provides a modulation intensity slider, an **Invert** button, a Lag control, and an optional Modulation Shaper. To find out what these controls do, refer to section [Assignment controls](#) of this manual. In contrast to normal Modulation Router entries, though, entries that pertain to Zone Envelope assignments can't be created in the usual way of assigning other modulation sources; the only way to add them is implicitly by creating a Zone Envelope within the Wave Editor.



Adjustments made to parameters for individual Zones stand in proportion to adjustments made on Group level: The value of a parameter for a single Zone can only be edited in relation to the value of the corresponding parameter on Group level.

**i** Editing parameters for factory content is only possible on Group level.

## Editing Envelopes

After you have created a new Zone Envelope, it will be selected right away and displayed within the waveform view of the Wave Editor as an orange, horizontal line. Zone Envelopes work similarly to flexible envelopes (refer to [Flexible Envelopes](#)) in that they consist of a series of breakpoints, which are connected by either straight lines or curves. The minimum length of a Zone Envelope is predetermined by the length of your Sample, though. At the beginning of the envelope, you'll notice a small rectangle; this is the first breakpoint of your envelope. Click this breakpoint and drag it up or down to change the envelope's initial level.

To add a new breakpoint, right-click ([Ctrl]-click on Mac OS X) somewhere within the waveform view. Kontakt will connect the new breakpoint to its neighbors with straight lines. You can change each breakpoint's level and position in time by clicking on it and dragging it around; the waveform display in the background provides visual feedback if you want to align it to features of your Sample. The envelope display will always keep in sync with the waveform; thus, zooming in and out of the waveform or scrolling the view, as described at the beginning of this chapter, will change the envelope view accordingly.

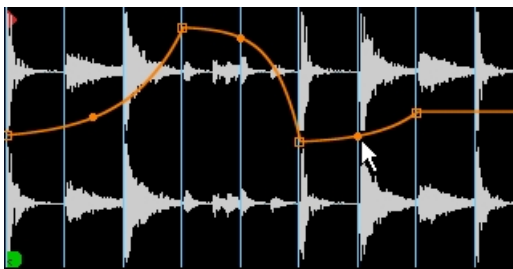

*Zone Envelopes allow you to create arbitrarily complex modulation shapes.*

In the middle of a segment between two breakpoints, you'll notice a small, filled circle. Clicking on this circle and dragging it up or down will change the curve shape of this segment. To remove a breakpoint from your envelope, right-click ([Ctrl]-click on Mac OS X) on it.

If the Grid is active, all breakpoints will snap their position in time to the nearest Slice marker when you move them. This allows you to create rhythmically useful modulation patterns very quickly. Also, the Pencil Tool explained below allows you to create straight envelope lines for each Slice.

When you use this function in combination with the Beat Machine, as explained in section [Using the Beat Machine](#), it opens up a whole range of possibilities that were only possible in previous Kontakt versions if you separated each Slice into its own Group: since straight lines, as created with the Pencil Tool, set the target parameter to a value that will remain constant over the duration of the Slice, you can easily adjust parameters for each Slice separately. As an example, suppose you're playing a sliced dub drum loop via the Beat Machine and want to add reverb to a single snare hit. To accomplish this, add a reverb module to a free Instrument Send Effects slot first, then insert a Send Levels module into the Group Insert Effects chain of the Group that contains your drum loop. Now, with the Sample being displayed in the Wave Editor and the **Zone Envelopes** tab selected, click the send level button in the panel of the Send Levels module which corresponds to the reverb. The name of this send parameter should now appear in the **Add:** button on the **Zone Envelopes** tab. Click this button; a new envelope will appear in the waveform view. Now select the Pencil Tool and click inside the Slice of the snare hit that you'd like to process; a new "plateau" will be added to your envelope at this spot. Clicking and dragging it allows you to adjust the reverb level of this slice in isolation. With a little creative thinking, the possibilities of this approach are virtually boundless.

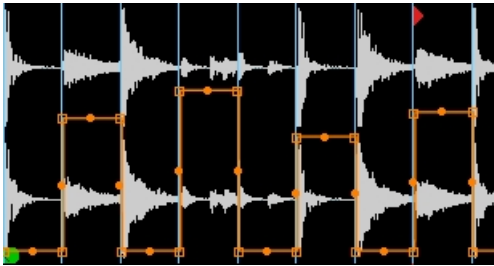

Using the Pencil Tool and/or the Randomize Env function, you can quickly change Group-level parameters for each Slice in isolation.

You can cut, copy, and paste regions of your Zone Envelope. For this purpose, the waveform view provides a selection feature and a paste cursor. When you click anywhere in the waveform view and drag your mouse horizontally, Kontakt will highlight the selected region; you can change an existing selection by clicking and dragging one of its borders, or move it across the envelope by clicking inside it and dragging your mouse horizontally. To put the contents of a selected region into the clipboard, click either Cut or Copy in the middle of the **Zone Envelopes** tab – Cut will remove the selected region in the process, while Copy won't change your envelope. To insert the clipboard contents into your envelope, click the **Paste** button below; Kontakt will insert the clipboard region at the position of your edit cursor, which is indicated with a vertical red line that you can position by clicking anywhere within the waveform view. This method also works across different envelopes.

## Utility Functions

The right side of the **Zone Envelopes** tab contains a number of utility functions that change the behavior of your currently selected Zone Envelope in various ways:

- **Loop Env:** When this button is activated, you can define a loop region within your Zone Envelope. This feature works similarly to the loop sections of flexible envelopes, though in contrast, it does not need to be anchored to breakpoints. This aspect is rather important, as Kontakt allows you to reproduce a loop region of your Zone within the envelope, which makes it possible to keep the Zone and its **Zone Envelope** in perfect sync during loops. Of course, you can just as well adjust your loop region freely and independently from any Zone loops; clicking and dragging one of its borders will resize it, and you can move it as a whole by clicking inside the region and dragging your mouse horizontally. Note that when you're using an envelope loop that doesn't match an identical loop region in your Sample, your envelope and the Sample will eventually drift out of synchronization.
- **Randomize Env:** If you're working on a sliced Sample, this button will create a random step pattern which changes its value at each Slice marker; using this feature, you can quickly create rhythmic modulation patterns that resemble classic "sample and hold" modulations of synthesizers. Using the Pencil Tool described below, you can easily change the level of each step. Note that this function will overwrite your currently selected Zone Envelope.
- **Get Param From Cur. S. Loop:** When you click this button, Kontakt will copy the start and end positions of the loop region that's currently selected on the **Sample Loop** tab and use them for your envelope's loop region. This is useful for getting your envelope in sync with a looped Sample.
- **Env Follows Playback Speed:** When this button is active, the selected Zone Envelope will always speed up or slow down in unison with your Sample. For instance, when you're playing your Sample an octave above its original pitch in Sampler or DFD mode, its playback speed will be doubled; enabling the **Env Follows Playback Speed** button ensures that the Zone Envelope will speed up accordingly, so that your Sample and its envelope always stay in sync. When this button is inactive, the envelope will always be processed at the original speed of the Sample.

- **Pencil Tool:** This button is located above the **Cut**, **Copy**, and **Paste** buttons in the middle of the **Zone Envelopes** tab. It provides a tool that lets you create and edit straight lines between Slice markers. This way, the target parameter of your envelope will be set to a constant value during the length of the respective Slice. For example, you might want to adjust the volume of each Slice of a Beat Machine-triggered drum loop separately. When the **Pencil Tool** button is activated, clicking between any two Slice markers will create a straight horizontal line between them; you can change the level of these lines later by dragging them up or down with the Pencil Tool.

## Sample Editor

Most of the available operations in the Wave Editor work in a non-destructive way, which means that they affect only the playback of your Sample and don't change the actual Sample data on your hard disk. Therefore, they can be easily reversed if needed. This is not always what you'll want, though: for example, if your Sample starts with a region of excess silence, you might want to get rid of it permanently (instead of working around it by changing your Zone start markers). Similarly, if there's a DC bias in your Sample, there's no practical reason to keep it in there. For these cases, Kontakt provides a built-in collection of destructive editing tools that allow you to cut, copy, and paste your material, create fades and regions of silence, reverse portions of your Sample, normalize its peak levels, or remove any DC bias. To access Kontakt's palette of destructive editing tools, click the **Sample Editor** tab in the lower part of the **Wave Editor**. If any other currently loaded Instruments use the Sample which you're just trying to edit, Kontakt will ask you first which of these Instruments should adopt your changes, and which should keep the original version.



*The Sample Editor tab*

As you can see, the elements on this tab are split into three functional blocks, namely Edit, Transform, and Selection. The Edit tools let you remove and reorder regions of your sample, but leave the Sample data within these regions unaffected; the Transform tools process the actual Sample data, for instance by changing the level.

When the **Sample Editor** tab is selected, the behavior of the waveform view will depend on whether the Grid is active or not.



If the Auto Pre-Listen button in the tool bar of the Wave Editor is activated, Kontakt will automatically play your selected region whenever you change it.

If it's inactive, clicking into the waveform view will position a vertical marker at this location; this is the edit cursor, which indicates where the contents of the clipboard will be inserted when you select Paste. Clicking on the waveform and dragging your mouse horizontally will highlight a contiguous region of your Sample; all Edit and Transform commands will operate on this region. To change an existing selection, click its left or right border and drag it horizontally; holding the [Shift] key while doing this allows you to make finer adjustments. The boundaries of the currently selected region will also be displayed numerically in the Selection panel of the **Sample Editor** tab; you can adjust any of these values directly by clicking on it and moving your mouse vertically, or by double-clicking on it and entering a new value.

If the Grid is active, the position of the edit cursor, as well as all selection boundaries, will snap to the nearest Slice markers. You can select a contiguous series of Slices by clicking into a Slice and moving your mouse horizontally. Changing the left or right border of the selection or moving it as a whole works as described above, but the selection will remain tied to the Slice markers.

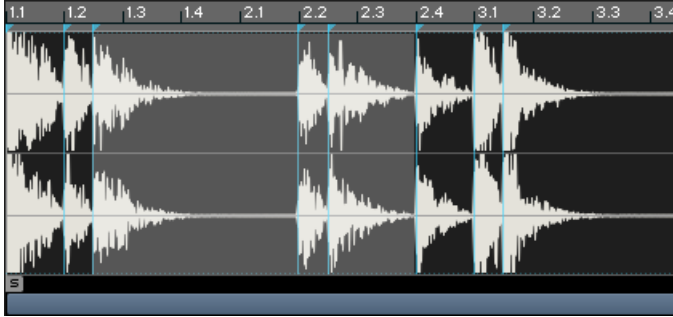

*Selecting slices for editing*

While you're working on your Sample, Kontakt will actually write out any changes to a backup copy, so your original file will be left untouched. Kontakt will create the backup copy inside a folder named "`__edited__`", which is located in your original Sample's location. Once you're finished with editing, your Instrument (and any other loaded Instruments that use this Sample and have been selected by you when you switched to the **Sample Editor** tab) will reference this backup copy instead, and you will hear your changes instantly. By saving your Instrument, you'll make the reference to the modified backup copy permanent; your original Sample will remain unaffected during the whole process, so other Instruments on your hard disk that use it will still work as expected.

Before we explain what each operation on the **Sample Editor** tab does, we should mention an important feature that will turn out to be rather helpful if things go wrong, namely the **Undo** and **Redo** buttons on the right of the tab.



*Undo and Redo button*

These work like the identical buttons in the Instrument Edit Rack header. Clicking on the curved arrow on the **Undo** button (left) will reverse the effects of the last operation, thus reverting the waveform to its former state; clicking on the small down arrow on the same button will open a drop-down menu with a list of the most recent operations that lets you select to which point in the operation history you want to return. Note that the last entry of this list will always be **Restore Orig.**, which will undo all changes that took place since you switched to the **Sample Editor** tab, thus restoring the Sample reference in your Instrument to the original Sample again. If you don't do any further editing on the **Sample Editor** tab after this, the "`__edited__`" folder will be deleted when you quit Kontakt. The **Redo** button to the right works similarly, but the other way around: it will restore any effects that you have just reversed with the **Undo** button.

## Edit Operations

**Cut:** Puts the currently selected region of your Sample into the Sample clipboard, removing it from the Sample in the process.

**Copy:** Leaves your Sample intact, but copies the selected region to the Sample clipboard for later use.

**Crop:** Removes all audio data outside the selection; in other words, the selected region will become your new Sample.

**Delete:** Removes the selected region from the Sample, without putting it into the clipboard.

**Paste:** Inserts the contents of the clipboard into your Sample. The insert location depends on whether a region is currently selected: if so, it will be replaced with the clipboard contents, which erases the previous contents of the region and will change the overall length of your Sample in most cases. If no region is selected, the contents of the clipboard will be inserted at the location of the edit cursor; this location is indicated with a vertical blue line, which you can position by clicking into the waveform view.

**Duplicate:** Inserts a copy of the selected region right after the region.

## Transform Operations

**Fade In:** Creates a smooth fade in from silence that spans the selected region.

**Fade Out:** Creates a smooth fade out into silence that spans the selected region.

**Silence:** Replaces the selected region with digital silence, i.e. a series of zero values.

**Reverse:** Reverses the selected region, so that it plays backwards.

**Normalize:** Amplifies the selected region to the greatest possible level without clipping. The Normalize function analyzes your Sample region and applies a gain factor that makes it utilize the entire available dynamics range; in other words, after you've used this operation, the highest peak in the region will just hit the 0 dB mark.

**DC Removal:** Detects and removes any DC bias from the selected Region. DC bias appears as a constant offset between the sample values and the zero line. While it's inaudible, it can reduce your headroom and cause problems at mixdown. Usually, you'll want to use this operation on your whole Sample.

## Script Editor

Kontakt includes a powerful and flexible scripting language processor, which is designed to let third-party developers come up with custom and complex ways in which users can interact with their Instruments and Multis. Although Kontakt's scripting language is easy enough to learn for anyone who has used a programming language before, a thorough reference would still go beyond the scope of this manual, so we've made it available as a separate PDF document that you'll find in the Documentation folder of your Kontakt installation. In this section, we'll keep to the basics of loading and using Scripts within the Script Editor.

There are some basic aspects of Scripts that you should be aware of, even if you'll only use pre-made Scripts. Scripts in Kontakt work like small programs that hook into Kontakt's way of processing notes, controller data, and user actions, enabling them to change Instrument parameters and MIDI data in a programmatic way. A very simple example would be a Script that alters incoming MIDI notes by transposing them up an octave, or creating a second voice that follows in octaves; more complex Scripts, though, can provide anything from powerful sequencer environments to realistic simulations of human instrument articulation.

Scripts are not only available on the Instrument level, but on the Multi level as well. This opens up a wide range of new possibilities in Script design; for instance, you can write Scripts that split and distribute MIDI data among multiple Instruments. For the most part, the scripting features that you can use on a global level are very similar to those on the Instrument level; there are some inherent differences, though, which are explained in the KSP Reference Manual.

Loading, editing and managing Scripts takes place in one of Kontakt's Script Editors. You can access the global editor, which contains Scripts that affect the Multi, by clicking on the button labeled KSP on the right side of the Instrument Rack Header.



The KSP button

In order to open the local editor of an Instrument, click the **Script Editor** button below its header when the Rack is in Edit mode. The Script Editors on the Multi and Instrument levels are mostly identical, and the explanations in the remainder of this chapter apply to both.

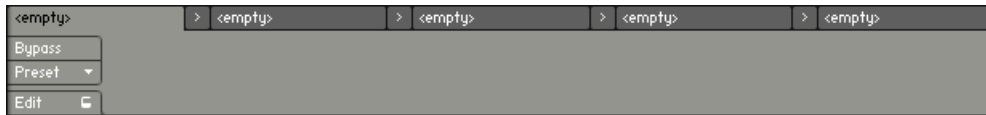

An empty Script Editor

At the top of the panel, you'll notice five tabs, each of them with an **empty** label. These are slots that can take up a Script each; if a Script changes any events, another script in a slot to its right will "see" the modified events. In other words, the five slots act as a chain of event filters. Below the slot tabs, there's an empty space; each script can provide its own user interface, which will appear here.

## Loading a Script

To load a Script, click the **Preset** button. A drop-down menu will appear, allowing you to select an item from the preset scripts folder of your Kontakt installation.

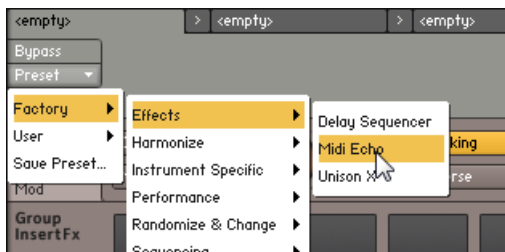

Loading a preset Script

After you've selected a Script, its user interface controls will appear in the space below the tabs. Most Scripts will work right away after loading; others might need you to do any meaningful adjustments first. You can always bypass a Script, thus temporarily deactivating it, by clicking on the **Bypass** button in the upper left corner of the Script Editor.

Whenever you're using a Script that provides its own controls, you can automate these like any other control of the Kontakt user interface; select the **Automation** tab in the Side pane and drag either a MIDI controller or a host controller ID onto the knob whose parameter you'd like to automate. For more information on how this works, refer to section [Automation Tab](#).

## Saving Script Settings

Whenever you have made a setting that you particularly like, you can save the Script in its current state for later re-use. Just click the Script button, then select the Save Preset command from the drop-down menu. A dialog will appear, asking you to enter a new filename for the Script. We don't recommend that you overwrite the original Script with your new settings, except if you want to change its default state for any later use.

Note that you don't need to explicitly save your Script if its settings are unique to your current project; its state will be saved along with your session or Multi. Also, some more sophisticated Scripts provide a built-in facility for preset management within the Script's user interface.



## Editing and Saving a Script

If you're into programming, you can browse and edit the source code of a Script via a built-in code editor. Click the **Edit** button in the lower left corner of the Script Editor; a text editor pane will open below the Script's user interface. Within this editor, you can make changes to the current Script, or write your own Script from scratch. Whenever you've made any changes, they won't affect the running Script right away; instead, the **Apply** button in the upper right corner of the source code editor will light up to remind you that you'll have to commit the changes first. You do this by clicking the **Apply** button; if the Script interpreter does not find any errors in your Script, your changes will be made active. Keep in mind, though, that you still need to save your Script in order to make the changes permanent.

## Locking a Script

If you want to protect the source code of your Script to keep others from browsing and editing it, you can lock it with a password while the source code editor is visible. To do this, click the **Lock with Password** button in the upper left corner of the source editor, enter a password twice, and click **OK**. Others can still use the script as it is, but the source code editor won't show up if they don't have the password.

Before you lock a Script, though, remember that there's a helpful and friendly community of fellow Script authors out there; locking your Scripts will keep them from finding and fixing bugs you might have missed or enhancing them with new features.



Even if a thorough explanation of the scripting language is beyond the scope of this manual, here's a neat trick we don't want to keep back: you can turn any panel of an Instrument Script into a Performance View, thereby making it visible and accessible within the Rack, simply by adding the statement "make\_perfview" in a new line somewhere between the lines "on init" and the following "end on", which can usually be found at the top of Scripts. After you click the Apply button and return to the Multi Instrument view, the Script controls will appear below the Instrument Header in the Rack. You can read more about the Performance View feature in section [Performance view](#) of this manual.

## Source Module

As its name suggests, the Source Module is located at the very beginning of Kontakt's signal flow and acts as the source of all audio signals. It provides access to the underlying sample playback engine, and as such can't be removed from an Instrument. It operates in one of ten playback modes, all of which are optimized for handling different audio material:

- **Sampler:** This is a traditional sample playback engine that keeps all sample data in your computer's RAM.
- **DFD (Direct from Disk):** This is a high-performance solution for streaming samples from disk in real-time.
- **Tone Machine:** In this mode, you can change the pitch and formants of your sounds independently from the playback speed.
- **Time Machine 1, Time Machine 2, and Time Machine Pro:** These playback modes allow you to compress and stretch your Samples in real-time, while leaving their pitch unaffected.
- **Beat Machine:** This mode handles rhythmic samples (such as drum loops) that have been "sliced", making them fit your song tempo.
- **Wavetable:** This mode enables wavetable synthesis, turning every zone in a given group into a separate wavetable oscillator.



- **S1200 Machine** and **MP60 Machine**: These are the two "vintage machine" modes. They emulate two classic samplers of the 80s, degrading the playback quality of the sample and changing how Kontakt changes the pitch and basic handling of the sample playback engine.

The mode of operation can be switched via the drop-down menu in the upper left corner of the Source Module's control panel. Note that the Source Module is located on the Group level, which means that each Group in your Instrument has its own Source Module, and changes to the playback mode only affect Zones within the Group to which the respective module belongs.

Let's have a look at how each of the playback modes works and what controls it does provide.

## Sampler

This is a "traditional" digital sampler that stores sample data in system memory, reads it out from memory, and applies any required transposition by re-sampling the audio data in real-time. The Sampler module is very efficient and draws little power from the host CPU.

Most of the available parameters in this mode can be modulated. Remember that all adjustments you make will affect all Groups that are currently selected for editing in the Group Editor.

The Sampler contains the following controls:

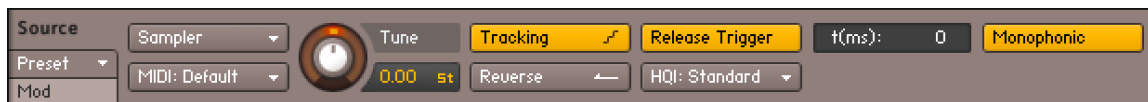

*The Sampler mode provides traditional, interpolated playback of Samples from memory.*

- **Tune**: Changes the playback pitch within one octave up or down. As this is a traditional sampler mode, changes to your pitch will always affect your playback tempo as well; if you want to adjust these parameters independently of each other, switch to one of the Tone Machine or Time Machine modes. This control works in semitone steps when moved, but you can make finer adjustments by holding down the [Shift] key as you move the knob.
- **Reverse**: Plays all Samples in the Group in reverse. Note that when this button is activated, playback will start at the End Marker of a Zone, so if there are a few seconds of silence at the end of a Zone, the sound will be delayed.
- **Tracking**: When activated, the pitch of the Sample playback will be transposed along with the key position. If your Group contains Zones that are mapped across several keys and should be played tonally, Tracking needs to be activated, or else all keys of the Zone will play at the same pitch. If you want to keep the pitch of a Sample constant across multiple keys or provide a separate Zone for each key (as it's the case with chromatically sampled Instruments), you can deactivate it.
- **MIDI**: Sets the MIDI port and channel this Group will respond to. Use this only if you want different Groups respond to different MIDI channels, otherwise set the Instrument's MIDI channel in the Instrument Header and leave this setting at its Default (Instrument) value.
- **Release Trigger**: When activated, samples in this Group will be triggered when a MIDI note-off command is received (as opposed to responding to note-on commands as usual). This function provides the necessary means for creating release samples. With these, you can recreate the natural release sound of an instrument, such as the damper on a harpsichord or a reverb trail recorded in the instrument's natural environment, when a key is being released. Note that if your release sample has a loop, there's no way to tell Kontakt to stop playing it from the outside (after all, that's what the note-off command was meant for in the first place), so you should make sure your Group has a volume envelope, or else it will keep playing indefinitely.

- **t(ms)** (Time, only visible if Release Trigger is activated): If you set this to a value other than 0, Kontakt will count from that value backwards in millisecond intervals when it receives a note, then stop the timer and provide its current value as a modulation source when it receives the corresponding note-off value. This way, you can make your Instrument respond to note durations, for instance by reducing the volume of your release sample after longer notes in order to make it fit a Sample with a natural decay.
- **Monophonic** (visible only if Release Trigger is activated): This button affects how release samples will respond to note repetitions. When it's activated, playing a note repeatedly will cut off any previous release samples that are still sounding (if any), so that only one release sample will play at any time.
- **HQI** (High Quality Interpolation): This drop-down menu allows you to choose from a list of 3 re-sampling algorithms of various quality. Only Samples that are played at a different note than their root key will need to be re-sampled. The Standard setting uses the algorithm of old Kontakt versions, which offers a reasonably good re-sampling quality while being light on the CPU. The **High** and **Perfect** settings select high-quality re-sampling algorithms, which eliminate virtually all audible artifacts (especially when transposing upwards), but need more CPU resources. Note that while the CPU demand of the **Standard** setting is constant, the **High** and **Perfect** settings will use more CPU resources the further they need to transpose a Sample from its root key; therefore, if you play a Sample two octaves above its original pitch, they will generate a higher CPU load than if you play it a semitone higher.

## DFD

The DFD mode uses an advanced streaming engine, which allows you to play very large Sample sets in real-time without having to load all sample data into RAM. This is accomplished by loading only the beginnings of all Samples into RAM (where they can be accessed instantly) and, as soon as a Sample is being played, streaming its remainder from your hard disk. This method has a few caveats that you'll need to keep in mind when creating your own Instruments, but they're usually far outweighed by the possibility of playing Instruments whose Sample data is anything from "inconveniently large" to "several times bigger than the size of your computer's RAM".

The controls for the source module's DFD mode are identical to those of the standard Sampler mode; all internal differences are transparently handled by Kontakt.

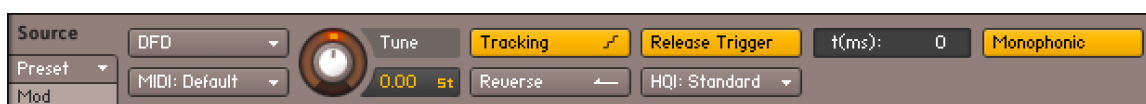

*The DFD mode streams Samples from your hard disk in real-time as they are triggered.*

When using DFD mode, consider the following:

- The maximum number of voices will most likely be lower compared to the Sampler module, as the latency and throughput of your hard disk will be a bottleneck for sampling performance. Therefore, you can optimize your overall voice count by putting only Groups and Instruments that access very large Samples into DFD mode, while keeping all others in Sampler mode.
- Do not try to use DFD mode with Samples that reside on a CD-ROM. Copy them to hard disk first.
- Although the DFD mode minimizes RAM usage in comparison to the Sampler mode, it still has a noticeable memory footprint, as it needs to pre-load the beginnings of all Samples into memory.
- You can switch between DFD and Sampler mode at any time. However, when switching from DFD to Sampler, there may be a slight pause, as the entire Sample set needs to be loaded into RAM.

## Wavetable

Wavetable synthesis is a sound synthesis technique that uses digitally sampled, single-cycle waveforms to produce musical tones. In Kontakt, you can use this technique by selecting wavetable mode in the Source Module. When this mode is selected, every zone in the given group is turned into a wavetable oscillator. All samples are interpreted as wavetables consisting of 2048 sample long wave cycles. This means that the root note settings are ignored, while all other Zone or Group settings work as expected.

The internal structure of a wavetable oscillator comprises of two main elements: a sawtooth oscillator, called the phase, and a set of values representing a number of waveforms, called the wavetable. The phase is used to read out a waveform from the wavetable once every cycle, thus reconstructing the waveform as the wavetable oscillator's output signal. By manipulating the wave shape of the phase, the resulting waveform can be bent and warped in interesting ways. In the Source module's wavetable mode, this can be achieved by using the Form controls.

Due to the low size of the single-cycle samples, wavetables can store multiple waveforms to use as the basis of your sound creation. By morphing through the disparate waveforms in the wavetable, you can create new and evolving wave shapes. This allows for diverse combinations of waveforms and complex timbral effects. You can achieve this in Kontakt by routing an LFO, envelope or MIDI control to modulate the Wavetable Position control. Digital interpolation increases the accuracy of the wavetable read-out and reduces aliasing noise. The type of interpolation contributes significantly to the character of the sound. Kontakt's Quality setting allows you to choose from four different types of interpolation.

Wavetable synthesis offers a wide range of sounds that can be explored in a dynamic and flexible way. From recreations of acoustic instruments to various synthesis techniques, the wavetable module allows you to expand the tones and timbres of your sound.

## Main controls

Wavetable mode contains the following main controls:



- **Tune:** Adjusts the playback pitch in the range of -36 to +36 semitones. Pressing Shift while turning the control allows for fine adjustments.
- **Tracking:** When activated, the pitch follows the MIDI key position. When deactivated, the pitch won't follow the keyboard.
- **Quality:** Selects one of four types of interpolation applied to the wavetable read-out (LoFi, Medium, High and Best). Higher settings result in improved levels of accuracy and lower levels of aliasing noise, however require more CPU power.
- **Position:** Morphs between the waveforms included in the loaded wavetable.
- **Form 1 Type:** Selects one of 14 types of wave shaping that can be applied to the oscillator's phase. This fundamentally changes the way the wavetable is read out, therefore bending and warping the resulting waveform.
- **Form 1:** Adjusts the amount of wave shaping applied to the oscillator's phase by Form 1 Type. The type of wave shaping can be selected using the Form 1 Type drop-down menu.

- **Form 2 Type:** Selects one of 14 types of wave shaping that can be applied to the oscillator's phase. This fundamentally changes the way the wavetable is read out, therefore bending and warping the resulting waveform.
- **Form 2:** Adjusts the amount of wave shaping applied to the oscillator's phase by Form 2 Type. The type of wave shaping can be selected using the Form 2 Type drop-down menu.
- **Phase:** Adjusts the reset point the oscillator's phase. This determines the sound's start position in the waveform when a new note is triggered.
- **Ph Rand**(Phase Randomness): Adjusts the amount of randomness applied to the reset point of the oscillator's phase. This creates random deviations of the sound's start position when a new note is triggered. When Phase Randomness is set to 100, the Phase control does not have an effect.

### Release Trigger mode

Release trigger mode offers the following controls:



- **Release Trigger:** When activated, the wavetable will be triggered when a MIDI note-off command is received.
- **t(ms)** (Time, only visible if Release Trigger is activated): If you set this to a value other than 0, Kontakt will count from that value backwards in millisecond intervals when it receives a note, then stop the timer and provide its current value as a modulation source when it receives the corresponding note-off value. This way, you can make your Instrument respond to note durations, for instance by reducing the volume of your release sample after longer notes in order to make it fit a Sample with a natural decay.
- **Monophonic** (visible only if Release Trigger is activated): This button affects how release samples will respond to note repetitions. When it's activated, playing a note repeatedly will cut off any previous release samples that are still sounding (if any), so that only one release sample will play at any time.

### Inharmonic mode

Inharmonic mode offers the following controls:



- **Inharmonic:** Activates inharmonic mode, which allows you to stretch partials away from the harmonic series. When activated, the inharmonic control knob will appear.
- **Inharm:** Adjusts the amount of detuning for the second wavetable oscillator. Only visible when Inharmonic mode is activated.

### Modulation Oscillator

Then modulation oscillator offers the following controls:



- **Modulation Type:** Selects the type of audio rate modulation applied to the wavetable oscillator by the modulation oscillator.
- **Modulation Oscillator Waveform:** Selects the waveform of the modulation oscillator.
- **Mod Tune:** Adjusts the tuning of the modulation oscillator. Tuning is available in three modes: Semitones, Ratio (harmonics and subharmonics), and Hz (fixed frequency). Modes can be switched by clicking on the small **st** label under the knob.
- **Mod Amt:** Adjusts the amount of modulation applied to the wavetable oscillator by the modulation oscillator.

## Tone Machine

The Tone Machine mode offers you unprecedented control of your Samples' pitches and formant frequencies, which can both be changed independently from the playback speed. It accomplishes this by processing your audio signals with granular synthesis algorithms, and has tremendous potential for creative sound design, as well as lots of utilitarian applications.

When you switch your Source Module from Sampler or DFD mode into this mode, it needs to analyze your sample material first, which can take some time if you have lots of samples in this Group. A progress bar will indicate the current status of this analysis.

Note that since the Tone Machine handles your audio data in small chunks of sample values called "grains", all boundaries of Sample loop regions will be aligned to these chunks. In consequence, this can result in slightly inaccurate playback of loops.

The Tone Machine mode contains the following controls:



*The Tone Machine mode lets you adjust the speed and pitch of your Samples independently.*

- **Tune:** Changes the playback pitch within one octave up or down, without affecting the playback speed.
- **Smooth:** In order to reduce artifacts during playback, Kontakt will crossfade grains into each other. This control adjusts the shape of these very short crossfades. Higher values will result in a smoother pitch shift, but rhythmic material may lose definition and "punch". Lower values are prone to cause a buzzing sound, but will keep transients intact.

- **Speed:** Changes the playback speed independently of the pitch. This value is displayed as a percentage of the original speed by default, so 200% doubles the playback speed, while 50% halves it. The control goes all the way down to 0%, which freezes the sound at its current playback position. The Speed parameter can also be synchronized to your host or Master Editor tempo; in this mode, your samples will be stretched to match the length of a note value. To do this, click the displayed unit of the Speed control and select a note value from the drop-down menu, then dial in a numerator for this value with the **Speed** knob. To switch back to unsynchronized mode, just choose the **Default** entry from the drop-down menu.
- **Formant:** This control shifts the formant frequencies, which are the parts of your signal's frequency content that decide its predominant timbral characteristics, independently of the pitch.
- **DC Filter:** The Tone Machine algorithm can impose a DC bias upon your waveform in certain cases, which reduces headroom and can cause distortions. This button enables a filter that eliminates this bias and re-centers your waveform around its origin. It's recommended that you leave this activated.
- **Legato:** If this button is activated and you play multiple notes in a legato fashion, Kontakt will carry its current playback position over to each following note, rather than playing each Sample from the beginning.
- **Tracking:** If this button is activated, the playback pitch will depend on the notes that you play. When deactivated, the pitch won't follow the keyboard.
- **MIDI Channel:** Sets the MIDI port and channel this Group will respond to. Change this only if you want different Groups respond to different MIDI channels, otherwise set the Instrument's MIDI channel in the Instrument Header and leave this setting to its Default (Instrument) value.
- **Release Trigger:** Allows samples in this Group to be triggered when a MIDI note-off command is received. This function and its additional parameters are covered by the description of the Sampler mode above.
- **t(ms)** (Time, only visible if Release Trigger is activated): If you set this to a value other than 0, Kontakt will count from that value backwards in millisecond intervals when it receives a note, then stop the timer and provide its current value as a modulation source when it receives the corresponding note-off value. This way, you can make your Instrument respond to note durations, for instance by reducing the volume of your release sample after longer notes in order to make it fit a Sample with a natural decay.
- **Monophonic** (visible only if Release Trigger is activated): This button affects how release samples will respond to note repetitions. When it's activated, playing a note repeatedly will cut off any previous release samples that are still sounding (if any), so that only one release sample will play at any time.

## Time Machine 1

The Time Machine 1 works similarly to the Tone Machine in that it uses granular synthesis to render pitch and playback speed of your samples independent of each other. It is optimized to alter the playback speed while leaving the pitch unaffected, thus providing a facility for real time time-stretching.

The Time Machine's controls are mostly identical to those of the Tone Machine. In addition, it offers the following controls:



The Time Machine 1 performs time-stretching of your Samples in real time.

- **High Quality:** This button replaces the **DC Filter** button of the Tone Machine. When activated, the Time Machine will analyze the sample data in order to determine optimal grain boundaries for this material; disabling this will make the granular synthesizer work the same regardless of its source material. This especially affects playback quality at low speeds.
- **Grain:** This control replaces the **Formant** control of the Tone Machine. It determines the grain size of the granular synthesizer. Since the grain size is not static in Hi Quality mode, this control has little effect when you have activated the button described above.

## Time Machine 2

This module works in a similar way as the Time Machine 1, but uses enhanced algorithms that provide better quality time stretching and pitch shifting.

The Time Machine 2's controls are mostly identical to those of the Time Machine, with the following exceptions:



The Time Machine 2 mode is optimized for high-quality time stretching, especially of percussive material.

- **Transient Copy:** When this button is activated, transients in your material – instantaneous level changes that occur in percussive sounds – will be preserved as accurately as possible. Therefore, this mode is recommended when you're working with drum loops or other percussive material.
- **Transient (Transient Size):** When the Transient Copy function is activated, this control adjusts the duration of transients that will be left untouched.
- **Grain:** This drop-down menu allows you to choose from several grain sizes that are optimized for various types of source material. As the effects of various settings on your particular material is hard to predict, it's usually worth trying several settings until you have found the one that sounds best.

## Time Machine Pro

This module should be used for the highest quality, independent pitch-shifting and time-stretching. It is best used for realistic changes, not extreme effects. Due to the higher quality, the CPU and RAM consumption of this mode is rather high.

The Time Machine Pro's controls are mostly identical to those of the Time Machine, with the following exceptions:





The Time Machine Pro is the highest quality time-stretching mode.

- **Reverse:** Time Machine Pro is the only time machine module that offers a real-time audio reverse function.
- **High Quality:** Switches between "efficient" and "high quality" mode and displays advanced controls, which are described below.
- **Env Order** (Envelope Order): Sets the order of the spectral envelope (formant) estimation. The default is set to 25% which works fine for most material. If the input audio is really high pitched the order should be lowered, cogently, if the input audio is low pitched the value should be raised.
- **Frm Shift** (Formant Shift): Sets the spectral envelope's shift factor. The default is set to zero which works fine for most material. This spectral shift is performed before the overall pitch shifting.
- **Keep Formants:** Enabling this option allows for formant preserving pitch shifting.

**i** Time Machine Pro can only process stereo files. In case of more channels (surround), only the first two channels are processed, the others are muted.

## Beat Machine

The Beat Machine is a mode for tempo-synchronized playback of "sliced" Samples. In short, the slicing mechanism provides a way to change the playback speed of percussive audio material, such as drum loops, without the tendency to "slur" transients or introduce other artifacts that are common to other time-stretching methods. In contrast to these, though, slicing needs some prior human intervention, the idea being that you add markers to your Samples, which tell Kontakt where their distinctive parts — such as the drums in a drum loop — are located. After you've created those markers, Kontakt will be able to trigger these elements in time to your song with an internal sequencer. This sequencer is the Beat Machine.

If the task of placing markers in your Samples, which is referred to as "slicing", sounds daunting to you, don't worry. The intelligent slicing functions that you'll find in the Grid panel of the Wave Editor will make this task as simple as possible, and of course, once you've sliced a Sample, the slicing information will be saved along with the Instrument. What's more, there's lots of pre-sliced material available in the form of commercial loop libraries.

The process of slicing a Sample manually is described in detail in section [Grid Panel](#). Also, note that the **Sync / Slice** tab of the Wave Editor includes a **Use Beat Machine** button, which allows you to synchronize the Sample to your song tempo right away. In fact, you should always use the Use Beat Machine function instead of switching your Source Module into Beat Machine mode explicitly. Please refer to sections [Grid Panel](#) and [Sync / Slice Tab](#) of the Wave Editor chapter to learn how to slice your own Samples and use the Beat Machine to play them back.

The Beat Machine contains the following controls:





The Beat Machine mode shouldn't be activated manually; it's better to Slice your Samples first in the Wave Editor and then activate it via the Use Beat Machine button on the Sync / Slice tab.

- **MIDI Channel:** Sets the MIDI port and channel this Group will respond to. Change this only if you want different Groups respond to different MIDI channels, otherwise set the Instrument's MIDI channel in the Instrument Header and leave this parameter at its Default (Instrument) value.
- **Tune:** Adjusts the pitch at which each Slice will be played back within one octave up or down.
- **Speed:** Adjusts the speed at which the Slice pattern will be played back. When you're using the **Use Beat Machine** button on the **Sync / Slice** tab of the Wave Editor to synchronize your sliced Samples, the readout of this control will display Zone, which means that the speed gets automatically synchronized to your host tempo. Read about this mechanism in section [Using the Beat Machine](#). If you have activated the Beat Machine mode manually, the speed will be displayed as a percentage of the pattern's original speed, and can be synchronized manually by clicking on the displayed unit, then choosing a note value from the drop-down menu.
- **Tracking:** If this button is activated, the playback pitch will depend on the notes that you play. When deactivated, the pitch won't follow the keyboard.
- **Slice Atk** (Slice Attack): Since slicing can occur at spots in your Sample that can cause clicks when played back in isolation, Slices are being crossfaded into each other instead of just played back in succession. This control adjusts the attack time of the crossfade envelopes. As large values can weaken your transients, you should generally adjust this control to the lowest possible value that just avoids clicking.
- **Slice Rel** (Slice Release): Adjusts the release time of the crossfade that occurs between Slices.
- **Release Trigger:** Allows samples in this Group to be triggered when a MIDI note-off command is received. This function and its additional parameters are covered by the description of the Sampler mode at the beginning of this chapter.
- **t(ms)** (Time, only visible if Release Trigger is activated): If you set this to a value other than 0, Kontakt will count from that value backwards in millisecond intervals when it receives a note, then stop the timer and provide its current value as a modulation source when it receives the corresponding note-off value. This way, you can make your Instrument respond to note durations, for instance by reducing the volume of your release sample after longer notes in order to make it fit a Sample with a natural decay.
- **Monophonic** (visible only if Release Trigger is activated): This button affects how release samples will respond to note repetitions. When it's activated, playing a note repeatedly will cut off any previous release samples that are still sounding (if any), so that only one release sample will play at any time.
- **Internal Trigger:** This button is only included for backwards compatibility. Its function was used with slices that have been automatically mapped into Groups across the keyboard. As this function is replicated with Zones since the release of Kontakt 3, you need this button only if using Instruments that have been saved in previous Kontakt versions.

## S1200 Machine

The S1200 Machine is the first of the "vintage machine modes". It emulates the behavior of a classic drum sampler from the late 80s. It not only degrades the playback quality of the samples (to about 12-bit, 26kHz), but also changes the way Kontakt changes the pitch and basic handling of the sample playback engine.

The controls are similar to those of the Sampler or DFD modes, but with the omission of the Quality menu and the inclusion of a Static Filter menu.



*The S1200 Machine*

## MP60 Machine

The MP60 Machine is the second of the "vintage machine modes" and emulates the behavior of a different 80s classic sampler. As with the S1200, it not only degrades the playback quality of the samples, but also changes the way Kontakt changes the pitch and basic handling of the sample playback engine. It is generally of a higher sample quality than the S1200 mode.

The controls are similar to those of the Sampler or DFD modes, but with the omission of the Quality menu.



*The MP60 Machine*

## Amplifier Module

The Amplifier Module follows the Source Module and the Group Insert Effects chain in the Group level of Kontakt's signal flow. Its purpose is to adjust the volume and stereo panorama of the signal before it enters the Instrument level, and optionally change the default output channel assignment and the channel routing that occurs between the Group and the Instrument level. A particularly vital task of the Amplifier Module is brought about by combining it with modulation: this way, you can use volume envelopes, which are elementary in the creation of playable Instruments.

As it's a fundamental part of Kontakt's signal flow, the Amplifier Module can't be removed from a Group, nor can you have more than one Amplifier Module within a Group. All signals generated by the Source Module in the Group will pass through your Amplifier Module.

The Amplifier contains the following controls:



- **Volume:** Adjusts the overall level of all signals that originate from this Group.
- **Pan:** If the Group is being routed to a stereo Output Channel, this control allows you to place the signal in the stereo panorama. Note that the Volume and Pan controls affect the playback of all Zones in your Group; if you want to adjust these parameters on a per-Zone basis, change them in the Mapping Editor instead, or use Zone Envelopes, which are described in section [Zone Envelopes](#).

- **Phase Invert:** Switching this button on inverts the phase of the audio signal, so that negative signals become positive, and vice versa. It acts in the same manner as a phase invert button on a mixing console and has the same uses, namely to make sure that signals mix together without phase cancellation.
- **L/R Swap:** Activating this button will swap the left and right channels of a stereo signal.
- **Channel Routing:** Clicking this button will open a routing matrix below the panel, which allows you to change the channel assignment aspects of the connection between the Group and the Instrument level, as well as create special routing configurations for up-mixing or down-mixing your Group signal to a different channel configuration. More details regarding this panel will be described later in this chapter.
- **Output:** This drop-down menu allows you to specify an alternate Output Channel, or Bus routing for this Group. When set to Default (Instrument), the Group's output is routed to the Instrument Insert Effects Chain, then to the output of the instrument, the Channel Output of which is selected from the Instrument Header. If you select a Bus from this dropdown, the group's audio will be routed to that Bus Effect Chain, then to the respective Bus's output (which, by default, is the Instrument Effect Chain). You can also send the Group's audio directly to a Channel Output, which will bypass any Bus and/or Instrument effects.

## Channel Routing Panel



A routing configuration which keeps the channel order and assignment intact, but lowers the second channel by -12 dB in volume.

Each horizontal row of this table corresponds to a channel of the Group signal that's present at the input of the Amplifier Module, as specified in the leftmost column. Each vertical column corresponds to an audio channel of the output that you've selected for this Instrument in the Instrument Header. You can create a connection between an input and an output channel by clicking into the field that is crossed by the respective row and column. An existing connection will be indicated with a colored rectangle; click it again to remove the connection.

For more complex routings that convert between different channel configurations, it's possible to send an input signal to multiple output channels, or to mix multiple input signals down to one output channel. You do this simply by creating more than one connection within a row (mix-up) or a column (mix-down). In such cases, it's often desirable to create connections with an intrinsic amplification or attenuation; for example, a common practice for mixing surround signals down to stereo is to fold the rear signal to the stereo channels at a lower volume. This can be accomplished in the Channel Routing matrix by right-clicking into the fields of existing connections, which will change the level of this connection as indicated by the color of the rectangle. Repeated clicking will cycle through a number of preset levels, which are displayed with their respective colors at the bottom of the routing matrix.

## 10. Using filters and effects in Classic view

Kontakt has a sophisticated signal flow structure that allows you to create flexible signal routings and process your audio signals with a range of effects and filters. This chapter will provide an overview on how to work with Kontakt's signal processing modules; it will explain what kinds of modules are available and how they can be used in an optimal way. The term 'signal processor' refers to both effects (audio processors you would expect in a typical multi-effects device) and filters (modules that change the frequency content of your signals).

The following chapters will provide in-depth descriptions of the effects and filters available in Kontakt's extensive collection of signal processors, but for the moment let's stick to the general basics. The following diagram depicts Kontakt's signal flow structure:

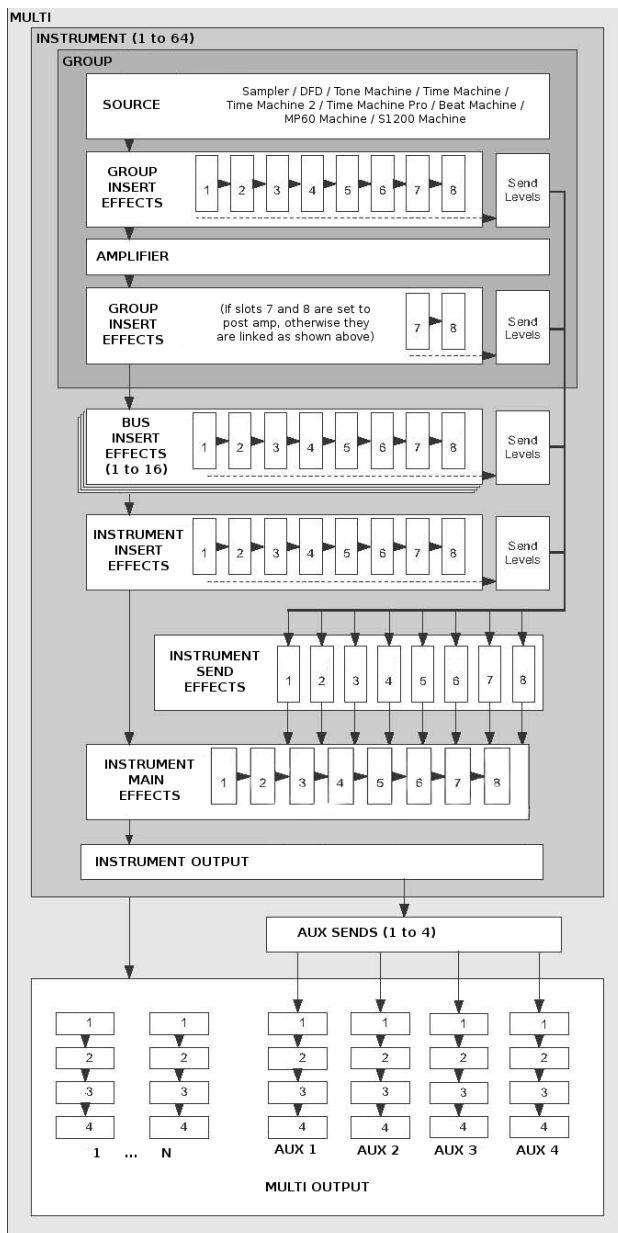

Audio Signal Path

Take a look at the five rows of eight slots each that reside within the Instrument and Group structures: these are the slots that can take up signal processor modules of your choice. Four rows – titled Group Insert Effects, Bus Insert Effects, Instrument Insert Effects, and Main Effects – form chains of insert modules. This means that the audio signal is processed in its entirety by each of the signal processors in the order in which they are placed in the chain, with the output of the rightmost module in the chain being used as the output signal of the Group, Bus or Instrument.

In contrast, the slots of the Instrument Send Effects section take up modules that work independently from each other in a parallel fashion. The idea behind send effects is that you can “tap” your signals at various points of the signal flow, and send them to a send effect at an adjustable level.

If you're familiar with how signal processors are used in a studio environment, with devices like compressors and equalizers usually being inserted into the signal flow, and effects like reverbs being fed through the aux sends of a mixing console and added back to the main mix, you'll discover that Kontakt's signal flow replicates these concepts and uses the same terminology in a lot of cases. Let's take a closer look at each row of slots.

## Group insert effects

This chain takes up to eight modules which will process the output signal of a specific Group in the order of their placement in the chain. Here's a typical application example: Suppose you're creating a drum kit Instrument, which has the typical array of drums (e.g. bass drum, snare, toms, and cymbals) separated into a Group for each drum. The snare is a bit lacking in "punch", so you want to use a compressor with a long attack time to bring out its initial "slam, but you don't want your cymbals to be treated in the same way. You can enable the "snare" Group in the Group Editor for editing (take care that you deactivate all other Groups, or else their chains will be changed in unison), and add the compressor to this Group's Group Insert Effects chain. Only the snare sounds will pass the compressor; all other Groups are unaffected.

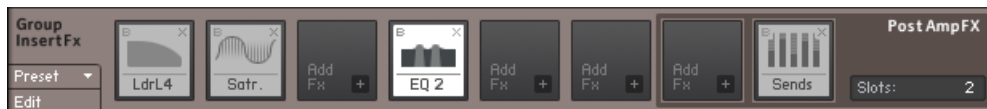

*The Group Insert Effects Chain*

The Group Insert Effects chain has an additional feature that separates it from the Instrument Insert Effects chain: while the slots to the left of the chain always receive the signal before it enters the Amplifier module, the slots on the right can optionally be placed after the Amplifier module in the signal flow. This is very useful in cases where you want to use the Send Levels module, which allows you to send signals to modules in the Instrument Send Effects slots. While you usually wouldn't want the operation of a distortion effect to be affected by your volume envelope, and therefore would place it before the Amplifier, sending a pre-Amplifier signal to a reverb or delay can give unexpected results. In most cases, you'll want send effects to receive the output of the Amplifier as you're hearing it, so placing the Send Levels module in one of the two rightmost slots by default is a good idea.

To specify the number of post-amplifier effects:

- ▶ Click and drag on the numeric value in the **PostAmpFX** section.

There are a few other details to keep in mind when you're working with Group Insert Effects:

- Group insert modules work in a polyphonic fashion, which means that their effect will be computed separately for each voice that you play. In some cases, this can result in different sounds than you might expect, for instance when you use compressors or distortion effects. This behavior allows you to create modulations that work on a per-Voice basis, such as velocity-controlled distortion, or key-tracking filters. Keep in mind, though, that in consequence, this multiplies each module's CPU resources by the number of voices; if you don't need Group-specific or polyphonic processing, it's more efficient to move a module into the Bus or Instrument Insert Effects chain instead, where it will operate on the summed signal.
- Most parameters of Group insert effects can be modulated internally via a modulation matrix. This matrix can be accessed via the **Modulation** button in the lower left corner of an effect panel. Kontakt's modulation system is explained in detail in section [Modulation](#).
- Many of Kontakt's signal processors are capable of processing multichannel signals. If a compatible effect follows a multichannel zone or a Surround Panner, it will operate on all surround channels.

## Bus insert effects

You can select one of Kontakt's 16 Instrument Buses as an additional effect chain for several Groups. You can have up to 16 buses, each with an independent effect setup. You can select the Bus you wish to edit by clicking on the output level meter to the top of this section or by selecting it from the drop down menu below the **Edit All Buses** button. If you want to edit all Buses at once, activate the **Edit All Buses** button. While this button is active, any changes you make on the Bus level will affect all Buses at once.

The Bus level also has an amplifier section, with **Volume**, **Pan**, **Phase Invert**, and **L/R Swap** controls, as well as an output selector drop down. The **Output** menu functions much in the same way as the Group level, but with one extra option to route the output through the instrument output, but bypassing the Instrument Insert Effects Chain. To do this, select **program out (bypass insertFX)** from the Output menu.



*You can route Groups through the Instrument Buses for more flexible effect routing.*

The outputs of the Groups you have routed to any Bus are summed and processed together; all processors operate in a monophonic fashion, without any means to discern between voices. The effect chain section can be edited in a similar fashion to the Group Insert Effects Chain, but without the pre or post amp optional routing.

A typical application of the Instrument Buses would be if you had several different Groups, but these could be grouped into audio chains for similar processing, for example: drums. Here you may have different Groups for each articulation, but for the effects processing you want each instrument type (kick, snare, toms, etc) grouped together to be processed through different effect chains.

## Instrument insert effects

This chain operates on the summed output signal of all Groups and Buses (unless they are routed directly to an Output Channel). It works exactly as the Bus Insert Effects chain, with the exception that it doesn't offer an Amplifier section; any volume, pan and output control at this point is placed in the instrument header. Like the Bus Insert Effects Chain, all processors operate in a monophonic fashion, without any means to discern between voices. A typical application of modules in this chain would be a compressor or EQ that should operate on an Instrument signal in its entirety.

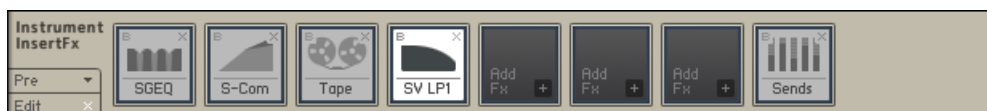

*The summed signals from your Groups will pass the Instrument Insert Effects chain just before they're sent to the Master Effects chain.*

## Instrument send effects

To use a module as a send effect, add it to one of your Instrument's Send Effects slots, and tap a source signal to be sent there by adding the Send Levels module to a Group, Bus or Instrument Insert Effects chain. A typical effect to be used in this way is a reverb: you might want to send different levels from the different parts of your instrument to the reverb, but then control the reverb as a single effect unit, Send Effects let you accomplish this.

The amount of signal that's being sent to the effect is called the send level, while the effect's output level is called the return level. In contrast to the Insert chains, the Instrument Send Effects work in parallel, and only receive signals that you explicitly send to them via the Send Levels module.

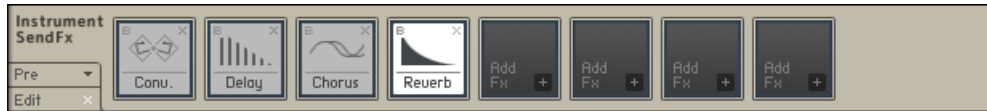

After you have added an effect to a slot in the Send Effects row, you will notice on its panel that it has a control labeled **Return** on its right side. This knob allows you to adjust the return level for this effect, as well as choose a routing target for its output signal by clicking on the small “**I**” icon next to the numerical readout.



Changing the output assignment of your send effects modules allows you to isolate wet effect signals from your Instrument's Output Channel.

**i** Note that you can send a signal to a send effect from more than one place within your Instrument. In such cases, the signals will be summed before they enter the effect; in other words, all send effects operate in a monophonic fashion.

## Main effects

The Main Effects chain operates on the summed output signal of all Insert Effects and Send Effects (unless they are routed directly to an Aux Channel). The chain is comprised of eight module slots which act as the final processor chain of your signal before the Instrument Output. The eight modules will process the signal of the selected Instrument in the order of their placement in the chain.

A typical use for the Main Effects section is to apply a limiter to the final output of your Instrument, in order to avoid digital clipping. Using a compressor in this chain enables you to control the final dynamic content of the signal, and also glue sounds together for a more well balanced sound. Modules in this chain should be applied with the intention of operating on an Instrument signal in its entirety.





The Main Effects Chain

## Common parameters

All signal processing modules have a few functions in common; you can find these on the left side of their parameter panels.

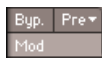

Each control panel provides buttons for bypassing the module, opening a list of presets, and showing or hiding the Modulation Router for this module if it resides on the Group level.

- **Byp. (Bypass):** Clicking on this button will toggle a bypass mode, which causes the module to pass its input signal on to its output, without any processing taking place. In the process of tweaking parameters, it's sometimes easy to lose objectivity and unintentionally go "over the top" with your processing, so it's good practice to re-check your signal against the unprocessed sound every so often when you're tweaking parameters.
- **Pre (Preset):** This button opens a drop-down menu which allows you to pick a set of parameter values for this module from Kontakt's preset library, as well as save your current settings as a new preset. Note that the insert and send slot rows (and, for that matter, most other modules in Kontakt) have their own preset menus; these allow you to load and save entire signal processing chains.
- **Mod (Modulation):** Only modules that have been added as Group inserts have this button. It opens a Modulation Router, which allows you to create modulation assignments for most effect parameters via Kontakt's internal modulation system. The modulation system is explained in section [Modulation](#).

## Adding modules

There are two ways of adding a signal processing module to a slot:

- ▶ To add an Effect Module to a slot, click the **+** icon in the lower right corner of an empty slot and select a module from the drop-down menu.

To change a module's position in a chain, you can drag it onto the separator line between two slots; a vertical line will appear if it can be moved to this position. All modules to the right of this position (if any) will move one slot further to the right in order to make place for the module.

## Deleting modules

To delete a module from a slot, either click on the **X** icon in the upper right corner of the module field, or select this module's parameter panel and press the delete key on your keyboard.

## Editing module parameters

Whenever you add a signal processing module to a slot, this module's control panel will appear below the slot row. The panel can be shown and hidden by either clicking the button labeled Edit in the lower left corner of the row, or by double-clicking on an effect module in that row. While the control panel is visible, it will show the controls of the currently selected module; clicking on another module will switch over to that one, so there will be only one module's panel displayed below the row at any time.



Each signal processing module provides a panel with controls that let you adjust its parameters.

## Signal processors in the Outputs section

The facilities described so far in this chapter allow you to use signal processors in various places and configurations throughout your Instrument. But what if you want an effect to operate on more than one Instrument in your Multi?

For this reason, Kontakt also provides effect slots that can be used to perform signal processing in both flavors — as inserts or sends — within the Outputs section, which is described in detail in section [Modulation](#) of this manual. Inserts are provided within the Output Channel strips, while separate channels, called Aux Channels, provide the necessary means to use send effects across Instruments. Let's look at both of these in detail.

### Output channel inserts

Display the Outputs section from the Workspace menu. To the left, you'll see one or more output channel strips. Just below the channel name at the top, there are four slots; this is the insert chain for the respective channel. If you can't see these slots, check that the Outputs panel is maximized by clicking on the button to the top right of the Outputs section.



The Output Channels with Effects inserted

The Output Insert chain works exactly the same as the Bus Insert Effects or Instrument Insert Effects chains, though laid out in a vertical fashion, with the topmost slot being the first of the chain. Clicking on the small arrow icon next to a slot will open a drop-down menu with the names of all available signal processors. Once you've selected and inserted a module from this list, you can show and hide its parameters for editing either by clicking on its name. Opening the drop-down menu and selecting the Empty label at its top will remove a module from the chain.

## Aux channels

Remember that the Instrument Send Effects slots provide a means to use effect modules as send effects, which can be used across multiple Groups and Buses; in a similar fashion, Aux Channels allow you to use send effects across multiple Instruments. You'll find the Aux Channel strips on the right side of the Outputs section mixer; technically, they're just additional output strips that get their signals from different places throughout the signal flow. Consequently, this also means that effects can be added in the same way as with the normal output channel strips; just open the drop-down menu at one of the insert slots and select a signal processor for the respective slot.

The Aux Channels can be fed from two places in Kontakt. By clicking on the **aux** button in the Rack header in Multi Instrument mode, a row of level controls will appear below each Instrument Header. With these controls, you can send the respective Instrument's output signal to one or multiple Aux channels at adjustable levels.



*Instrument Aux Sends*

Alternatively, you can re-route the output signal of any effects module that you added to a Send Effects slot to one of the Aux Channels. While this might seem counter-intuitive at first, it makes sense when you consider that you might want to access the wet signal of a send effect separately from the main output; routing it to an Aux Channel not only allows you to further process the wet signal in isolation, but also makes it possible to route the signal to different physical Kontakt outputs. You can also use the Gainer module within a Send Effects slot to build a "bridge" to the Aux channels and feed them with Group-specific signals; this process is explained in section [Gainer](#) of this manual.

# 11. Filter reference

A filter is a signal processor which changes the frequency content of a signal that passes through it. This means that in contrast to effects like distortion, reverb, or chorus, it only changes the amplitude and phase of frequency components which are already present in your signal, without creating new frequency content.

Filters are generally distinguished by the part of the spectrum that is to be attenuated, and steepness of their attenuation curve, which is usually expressed in dB per octave. As the cutoff frequency is defined as the frequency where an attenuation of 3 dB occurs, a lowpass filter slope of 12 dB/octave with a cutoff frequency of 440 Hz attenuates frequency content at 880 Hz (an octave above the cutoff frequency) by 15 dB, frequencies at 1760 Hz by 27 dB, and so on. In digital filter design, specifying a filter slope as a number of “poles” has become the norm, with each pole corresponding to 6 dB of attenuation per octave, such that a 1-pole filter will exhibit a gentle slope of -6 dB/octave, while a 6-pole filter with its slope of -36 dB/octave is more akin to a sonic razor blade. The pole notation is being used for Kontakt’s collection of sampler filters. If you find the concept of filter slopes confusing, don’t worry – just remember that lower-order filters (like 1-pole and 2-pole forms) are generally better suited for gentle, unnoticeable tonal corrections, while higher-order filters (like 4-pole and 6-pole forms) tend to change your signal characteristics by a significant amount, and are thus better suited for broad treatments or effects.

Kontakt’s collection of filter modules is divided into 7 categories:

- **Lowpass Filters** attenuate harmonics and signals above the cutoff frequency.
- **Highpass Filters** attenuate signals below the cutoff frequency.
- **Bandpass Filters** attenuate signals above and below the cutoff frequency.
- **Peak/Notch Filters** A notch filter is like the inverse of a Bandpass filter, as it only removes signals around the cutoff frequency, but allows the signals above and below it to pass through. A peak filter is like a very narrow Bandpass.
- **Multi Filters** in this section you will find optimized combinations of filter types in different routings.
- **Effect Filters** are special filter modules that don’t fit any of the traditional filter characteristics of either lowpass, highpass, bandpass or band rejection. An example of these would be vowel filters, which emulate the resonances of the human vocal tract.
- **EQs** are the kind of frequency tools that you can find on mixing consoles. They offer some ways of tonal alteration which aren’t available with traditional filters, such as attenuating or boosting a specific frequency range by an adjustable amount and with adjustable precision.

These categories contain a few different variations based on the steepness of the slope (or number of poles) and the character of the algorithm. There are five main filter variations:

- **State Variable (SV):** These are the new standard Kontakt filters. They have a clean character which is suitable for any material.
- **Legacy:** In order to remain backwards compatible, the filter designs from before Kontakt 5 are included with the tag Legacy. These are like the SV filters but use a much older algorithm. If you are planning to use clean filters, we advise you use the newer SV filters.
- **Adaptive Resonance (AR):** The AR filters scale the resonance of the filter by the inverse of the amplitude of the input signal. At higher input levels, the resonance of the filter will be reduced, which helps reduce nasty peaks in the output audio. Accordingly, these filters are best used on drums, loops or full mix material.

- **Ladder:** Based on the classic ladder circuit used in early synthesizers, these filters would be a first choice for synthetic sounds, but can work well on any signal. There is also a Legacy Ladder available, based on an older algorithm.
- **Daft:** Taken from the Massive filter collection, the Daft filter is a more aggressive synthesizer filter design.
- **Pro 53:** Taken from Native Instruments classic Pro-53 synthesizer, this filter emulates the analogue synthesizer filter from the early 80s.

The most convenient way to access Kontakt's filter collection is by browsing the Filters page on the **Modules** tab of the Browser. Here you'll find a list of all available filters in each of the seven categories, with icons depicting their frequency response, and descriptions of what they do and how you can use them. If you have found a filter that you'd like to try, just drag it into one of your Instrument's signal processor slots.

In the following subsections, we'll briefly introduce the available filter modules in Classic view in each category and describe their parameters.

## Lowpass filters

This category contains filters which attenuate signals above the cutoff frequency, allowing low frequency signals to pass through - hence the name Lowpass. All filters in this category have the following controls, unless otherwise specified:

- **Cutoff:** Adjusts the frequency above which signals will be attenuated.
- **Reso.** (Resonance): With a value greater than 0, this control will boost a small frequency range around the cutoff frequency.

### SV LP1

The State Variable (SV) filters have a clean characteristic that can be used for all kinds of audio signals. The LP1 is a 1-pole lowpass, which attenuates frequencies above the cutoff at a rate of -6 dB/octave. The 1-pole filter does not have a Resonance control.

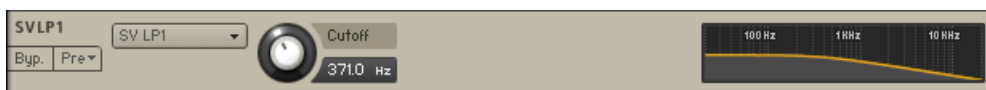

The SV LP1 module

### SV LP2

The State Variable (SV) filters have a clean characteristic that can be used for all kinds of audio signals. The LP2 is a 2-pole low-pass, which attenuates frequencies above the cutoff at a rate of -12 dB/octave.



The SV LP2 module

### SV LP4

The State Variable (SV) filters have a clean characteristic that can be used for all kinds of audio signals. The LP4 is a 4-pole low-pass, which attenuates frequencies above the cutoff at a rate of -24 dB/octave.



The SV LP4 module

## SV LP6

The State Variable (SV) filters have a clean characteristic that can be used for all kinds of audio signals. The LP6 is a 6-pole low-pass, which attenuates frequencies above the cutoff at a rate of -36 dB/octave.



The SV LP6 module

## Ladder LP1

Based on the classic ladder circuit used in early synthesizers, these filters would be a first choice for synthetic sounds, but can work well on any signal. The LP1 is a 1-pole lowpass, which attenuates frequencies above the cutoff at a rate of -6 dB/octave.

The Ladder LP1 filter also includes the following controls:



The Ladder LP1 module

- **High Quality:** Toggles oversampling within the effect, which can increase audio quality, but will also increase CPU load.
- **Gain:** Controls the amplitude increase after the filter. This control can be used to compensate for amplitude reduction due to the filter, or to increase the soft saturation of the effect.

## Ladder LP2

Based on the classic ladder circuit used in early synthesizers, these filters would be a first choice for synthetic sounds, but can work well on any signal. The LP2 is a 2-pole low-pass, which attenuates frequencies above the cutoff at a rate of -12 dB/octave.

The Ladder LP2 filter also includes the following controls:



The Ladder LP2 module

- **High Quality:** Toggles oversampling within the effect, which can increase audio quality, but will also increase CPU load.
- **Gain:** Controls the amplitude increase after the filter. This control can be used to compensate for amplitude reduction due to the filter, or to increase the soft saturation of the effect.

## Ladder LP3

Based on the classic ladder circuit used in early synthesizers, these filters would be a first choice for synthetic sounds, but can work well on any signal. The LP3 is a 3-pole lowpass, which attenuates frequencies above the cutoff at a rate of -18 dB/octave.

The Ladder LP3 filter also includes the following controls:



*The Ladder LP3 module*

- **High Quality:** Toggles oversampling within the effect, which can increase audio quality, but will also increase CPU load.
- **Gain:** Controls the amplitude increase after the filter. This control can be used to compensate for amplitude reduction due to the filter, or to increase the soft saturation of the effect.

## Ladder LP4

Based on the classic ladder circuit used in early synthesizers, these filters would be a first choice for synthetic sounds, but can work well on any signal. The LP4 is a 4-pole low-pass, which attenuates frequencies above the cutoff at a rate of -24 dB/octave. The Ladder LP4 filter also includes the following controls:

The Ladder LP4 filter also includes the following controls:



*The Ladder LP4 module*

- **High Quality:** Toggles oversampling within the effect, which can increase audio quality, but will also increase CPU load.
- **Gain:** Controls the amplitude increase after the filter. This control can be used to compensate for amplitude reduction due to the filter, or to increase the soft saturation of the effect.

## AR LP2

The Adaptive Resonance (AR) filters follow the amplitude of the input signal and adjust the resonance accordingly. At higher input levels, the resonance will reduce, and for lower levels it will increase, this avoids unpleasant peaks. These filters work best on full loops or drums. The LP2 is a 2-pole low-pass, which attenuates frequencies above the cutoff at a rate of -12 dB/octave.



*The AR LP2 module*

## AR LP4

The Adaptive Resonance (AR) filters follow the amplitude of the input signal and adjust the resonance accordingly. At higher input levels, the resonance will reduce, and for lower levels it will increase, this avoids unpleasant peaks. These filters work best on full loops or drums. The LP4 is a 4-pole low-pass, which attenuates frequencies above the cutoff at a rate of -24 dB/octave.



The AR LP4 module

## AR LP2/4



The AR LP 2/4 module

The Adaptive Resonance (AR) filters follow the amplitude of the input signal and adjust the resonance accordingly. At higher input levels, the resonance will reduce, and for lower levels it will increase, this avoids unpleasant peaks. These filters work best on full loops or drums. The LP2/4 processes the audio through a combination of 2-pole and 4-pole lowpass filters to create a more interesting frequency response.

## Daft

The Daft filter has been adapted from Massive and is a more aggressive synthesizer filter design. The response of the filter is a 2-pole low-pass, which attenuates frequencies above the cutoff at a rate of -12 dB/octave. The daft filter also includes a **Gain** knob that controls the amplitude increase after the filter. This control can be used to compensate for amplitude reduction due to the filter, or to increase the soft saturation of the effect.



The Draft module

## PRO-53

This is the same filter section that is provided by Native Instruments' PRO-53 software synthesizer. It's similar in nature to the 4-pole lowpass filter, but has a different and more distinctive signature sound.



The PRO-53 module



## Legacy LP1

In order to remain backwards compatible, the filter designs from before Kontakt 5 are included with the tag Legacy. These are like the SV filters but use a much older algorithm. If you are planning to use clean filters, we advise you use the newer SV filters. The LP1 is a 1-pole lowpass, which attenuates frequencies above the cutoff at a rate of -6 dB/octave. The 1-pole filter does not have a Resonance control.



The Legacy LP1 module

## Legacy LP2

In order to remain backwards compatible, the filter designs from before Kontakt 5 are included with the tag Legacy. These are like the SV filters but use a much older algorithm. If you are planning to use clean filters, we advise you use the newer SV filters. The LP2 is a 2-pole lowpass, which attenuates frequencies above the cutoff at a rate of -12 dB/octave.



The Legacy LP2 module

## Legacy LP4

In order to remain backwards compatible, the filter designs from before Kontakt 5 are included with the tag Legacy. These are like the SV filters but use a much older algorithm. If you are planning to use clean filters, we advise you use the newer SV filters. The LP4 is a 4-pole lowpass, which attenuates frequencies above the cutoff at a rate of -24 dB/octave.



The Legacy LP4 module

## Legacy LP6

In order to remain backwards compatible, the filter designs from before Kontakt 5 are included with the tag Legacy. These are like the SV filters but use a much older algorithm. If you are planning to use clean filters, we advise you use the newer SV filters. The LP6 is a 6-pole lowpass, which attenuates frequencies above the cutoff at a rate of -36 dB/octave.



The Legacy LP6 module

## Legacy Ladder

In order to remain backwards compatible, the filter designs from before Kontakt 5 are included with the tag Legacy. The Legacy Ladder is like the previously mentioned Ladder filters but uses a much older algorithm. Accordingly we advise you use the non-Legacy Ladder filters. The Legacy Ladder is a 4-pole filter, which attenuates frequencies above the cutoff at a rate of -24 dB/octave.



The Legacy Ladder module

## Highpass filters

This category contains filters which attenuate signals below the cutoff frequency, allowing high frequency signals to pass through - hence the name Highpass. All filters in this category have the following controls, unless otherwise specified:

- **Cutoff:** Adjusts the frequency below which signals will be attenuated.
- **Reso.** (Resonance): With a value greater than 0, this control will boost a small frequency range around the cutoff frequency.

### SV HP1

The State Variable (SV) filters have a clean characteristic that can be used for all kinds of audio signals. The HP1 is a 1-pole Highpass, which attenuates frequencies below the cutoff at a rate of -6 dB/octave. The 1-pole filter does not have a Resonance control.



The SV HP1 module

### SV HP2

The State Variable (SV) filters have a clean characteristic that can be used for all kinds of audio signals. The HP2 is a 2-pole high-pass, which attenuates frequencies below the cutoff at a rate of -12 dB/octave.



The SV HP2 module

### SV HP4

The State Variable (SV) filters have a clean characteristic that can be used for all kinds of audio signals. The HP4 is a 4-pole high-pass, which attenuates frequencies below the cutoff at a rate of -24 dB/octave.



The SV HP4 module

## SV HP6

The State Variable (SV) filters have a clean characteristic that can be used for all kinds of audio signals. The HP6 is a 6-pole high-pass, which attenuates frequencies below the cutoff at a rate of -36 dB/octave.



The SV HP6 module

## Ladder HP1

Based on the classic ladder circuit used in early synthesizers, these filters would be a first choice for synthetic sounds, but can work well on any signal. The HP1 is a 1-pole highpass, which attenuates frequencies below the cutoff at a rate of -6 dB/octave.

The Ladder HP1 filter also includes the following controls:



The Ladder HP1 module

- **High Quality:** Toggles oversampling within the effect, which can increase audio quality, but will also increase CPU load.
- **Gain:** Controls the amplitude increase after the filter. This control can be used to compensate for amplitude reduction due to the filter, or to increase the soft saturation of the effect.

## Ladder HP2

Based on the classic ladder circuit used in early synthesizers, these filters would be a first choice for synthetic sounds, but can work well on any signal. The HP2 is a 2-pole high-pass, which attenuates frequencies below the cutoff at a rate of -12 dB/octave. The Ladder HP2 filter also includes the following controls:

The Ladder HP2 filter also includes the following controls:



The Ladder HP2 module

- **High Quality:** Toggles oversampling within the effect, which can increase audio quality, but will also increase CPU load.
- **Gain:** Controls the amplitude increase after the filter. This control can be used to compensate for amplitude reduction due to the filter, or to increase the soft saturation of the effect.

## Ladder HP3

Based on the classic ladder circuit used in early synthesizers, these filters would be a first choice for synthetic sounds, but can work well on any signal. The HP3 is a 3-pole high-pass, which attenuates frequencies below the cutoff at a rate of -18 dB/octave.

The Ladder HP3 filter also includes the following controls:



The Ladder HP3 module

- **High Quality:** Toggles oversampling within the effect, which can increase audio quality, but will also increase CPU load.
- **Gain:** Controls the amplitude increase after the filter. This control can be used to compensate for amplitude reduction due to the filter, or to increase the soft saturation of the effect.

## Ladder HP4

Based on the classic ladder circuit used in early synthesizers, these filters would be a first choice for synthetic sounds, but can work well on any signal. The HP4 is a 4-pole high-pass, which attenuates frequencies below the cutoff at a rate of -24 dB/octave. The Ladder HP4 filter also includes the following controls:

The Ladder HP4 filter also includes the following controls:



The Ladder HP4 module

- **High Quality:** Toggles oversampling within the effect, which can increase audio quality, but will also increase CPU load.
- **Gain:** Controls the amplitude increase after the filter. This control can be used to compensate for amplitude reduction due to the filter, or to increase the soft saturation of the effect.

## AR HP2

The Adaptive Resonance (AR) filters follow the amplitude of the input signal and adjust the resonance accordingly. At higher input levels, the resonance will reduce, and for lower levels it will increase, this avoids unpleasant peaks. These filters work best on full loops or drums. The HP2 is a 2-pole high-pass, which attenuates frequencies below the cutoff at a rate of -12 dB/octave.



The AR HP2 module

## AR HP4

The Adaptive Resonance (AR) filters follow the amplitude of the input signal and adjust the resonance accordingly. At higher input levels, the resonance will reduce, and for lower levels it will increase, this avoids unpleasant peaks. These filters work best on full loops or drums. The HP4 is a 4-pole highpass, which attenuates frequencies below the cutoff at a rate of -24 dB/octave.



The AR HP4 module

## AR HP2/4

The Adaptive Resonance (AR) filters follow the amplitude of the input signal and adjust the resonance accordingly. At higher input levels, the resonance will reduce, and for lower levels it will increase, this avoids unpleasant peaks. These filters work best on full loops or drums. The HP2/4 processes the audio through a combination of 2-pole and 4-pole highpass filters to create a more interesting frequency response.



The AR HP 2/4 module

## Daft HP

The Daft filter has been adapted from Massive and is a more aggressive synthesizer filter design. The response of the filter is a 2-pole high-pass, which attenuates frequencies below the cutoff at a rate of -12 dB/octave. The Daft filters also include the following controls:

The Daft filters also include the following controls:



The Daft HP module

- **Gain:** Controls the amplitude increase after the filter. This control can be used to compensate for amplitude reduction due to the filter, or to increase the soft saturation of the effect.

## Legacy HP1

In order to remain backwards compatible, the filter designs from before Kontakt 5 are included with the tag Legacy. These are like the SV filters but use a much older algorithm. If you are planning to use clean filters, we advise you use the newer SV filters. The HP1 is a 1-pole highpass, which attenuates frequencies below the cutoff at a rate of -6 dB/octave. The 1-pole filter does not have a Resonance control.



The Legacy HP1 module

## Legacy HP2

In order to remain backwards compatible, the filter designs from before Kontakt 5 are included with the tag Legacy. These are like the SV filters but use a much older algorithm. If you are planning to use clean filters, we advise you use the newer SV filters. The HP2 is a 2-pole highpass, which attenuates frequencies below the cutoff at a rate of -12 dB/octave.



The Legacy HP2 module

## Legacy HP4

In order to remain backwards compatible, the filter designs from before Kontakt 5 are included with the tag Legacy. These are like the SV filters but use a much older algorithm. If you are planning to use clean filters, we advise you use the newer SV filters. The HP4 is a 4-pole highpass, which attenuates frequencies below the cutoff at a rate of -24 dB/octave.



*The Legacy HP4 module*

## Bandpass

This category contains filters which attenuate signals below and above the cutoff frequency. All filters in this category have the following controls, unless otherwise specified:

- **Cutoff:** Adjusts the frequency below which signals will be attenuated.
- **Reso.** (Resonance): With a value greater than 0, this control will boost a small frequency range around the cutoff frequency.

## SV BP2

The State Variable (SV) filters have a clean characteristic that can be used for all kinds of audio signals. The BP2 is a 2-pole band-pass, which attenuates frequencies above and below the cutoff at a rate of -12 dB/octave.



*The SV BP2 module*

## SV BP4

The State Variable (SV) filters have a clean characteristic that can be used for all kinds of audio signals. The BP4 is a 4-pole band-pass, which attenuates frequencies above and below the cutoff at a rate of -24 dB/octave.



*The SV BP4 module*

## Ladder BP2

Based on the classic ladder circuit used in early synthesizers, these filters would be a first choice for synthetic sounds, but can work well on any signal. The BP2 is a 2-pole band-pass, which attenuates frequencies above and below the cutoff at a rate of -12 dB/octave. The Ladder BP2 filter also includes the following controls:

The Ladder BP2 filter also includes the following controls:



The Ladder BP2 module

- **High Quality:** Toggles oversampling within the effect, which can increase audio quality, but will also increase CPU load.
- **Gain:** Controls the amplitude increase after the filter. This control can be used to compensate for amplitude reduction due to the filter, or to increase the soft saturation of the effect.

## Ladder BP4

Based on the classic ladder circuit used in early synthesizers, these filters would be a first choice for synthetic sounds, but can work well on any signal. The BP4 is a 4-pole band-pass, which attenuates frequencies above and below the cutoff at a rate of -24 dB/octave. The Ladder BP4 filter also includes the following controls:

The Ladder BP4 filter also includes the following controls:



The Ladder BP4 module

- **High Quality:** Toggles oversampling within the effect, which can increase audio quality, but will also increase CPU load.
- **Gain:** Controls the amplitude increase after the filter. This control can be used to compensate for amplitude reduction due to the filter, or to increase the soft saturation of the effect.

## AR BP2

The Adaptive Resonance (AR) filters follow the amplitude of the input signal and adjust the resonance accordingly. At higher input levels, the resonance will reduce, and for lower levels it will increase, this avoids unpleasant peaks. These filters work best on full loops or drums. The BP2 is a 2-pole band-pass, which attenuates frequencies below and above the cutoff at a rate of -12 dB/octave.



The AR BP2 module

## AR BP4

The Adaptive Resonance (AR) filters follow the amplitude of the input signal and adjust the resonance accordingly. At higher input levels, the resonance will reduce, and for lower levels it will increase, this avoids unpleasant peaks. These filters work best on full loops or drums. The BP4 is a 4-pole bandpass, which attenuates frequencies below and above the cutoff at a rate of -24 dB/octave.



The AR BP4 module

## AR BP2/4

The Adaptive Resonance (AR) filters follow the amplitude of the input signal and adjust the resonance accordingly. At higher input levels, the resonance will reduce, and for lower levels it will increase, this avoids unpleasant peaks. These filters work best on full loops or drums. The BP2/4 processes the audio through a combination of 2-pole and 4-pole bandpass filters to create a more interesting frequency response.



The AR BP 2/4 module

## Legacy BP2

In order to remain backwards compatible, the filter designs from before Kontakt 5 are included with the tag Legacy. These are like the SV filters but use a much older algorithm. If you are planning to use clean filters, we advise you use the newer SV filters. The BP2 is a 2-pole bandpass, which attenuates frequencies below and above the cutoff at a rate of -12 dB/octave. The Legacy BP2 does not have a Resonance control.



The Legacy BP2 module

## Legacy BP4

In order to remain backwards compatible, the filter designs from before Kontakt 5 are included with the tag Legacy. These are like the SV filters but use a much older algorithm. If you are planning to use clean filters, we advise you use the newer SV filters. The BP4 is a 4-pole bandpass, which attenuates frequencies below and above the cutoff at a rate of -24 dB/octave.



The Legacy BP4 module

## Peak and notch filters

A notch filter removes a specific frequency band from the signal. It can be thought of as the inverse of a bandpass filter - in fact, it is sometimes referred to as a "band reject" filter. A peak filter, on the other hand, is quite different - it simply adds a resonant peak to the signal, without doing much attenuation to the signal. All filters in this category have the following controls, unless otherwise specified:

- **Cutoff.** Adjusts the frequency below which signals will be attenuated.
- **Reso.** (Resonance): With a value greater than 0, this control will boost a small frequency range around the cutoff frequency.



## SV Notch

The State Variable (SV) filters have a clean characteristic that can be used for all kinds of audio signals. The Notch 4 is a 4-pole notch filter, which attenuates frequencies at the cutoff.



The SV Notch module

## Ladder Peak

Based on the classic ladder circuit used in early synthesizers, these filters would be a first choice for synthetic sounds, but can work well on any signal. The Peak is a unique filter that accents frequencies at the cutoff.

The Ladder Peak filter includes the following additional controls:



The Ladder Peak module

- **High Quality:** Toggles oversampling within the effect, which can increase audio quality, but will also increase CPU load.
- **Gain:** Controls the amplitude increase after the filter. This control can be used to compensate for amplitude reduction due to the filter, or to increase the soft saturation of the effect.

## Ladder Notch

Based on the classic ladder circuit used in early synthesizers, these filters would be a first choice for synthetic sounds, but can work well on any signal. The Notch cuts two narrow bands of frequencies at either side of the cutoff.

Ladder Notch includes the following additional controls:



The Ladder Notch module

- **High Quality:** Toggles oversampling within the effect, which can increase audio quality, but will also increase CPU load.
- **Gain:** Controls the amplitude increase after the filter. This control can be used to compensate for amplitude reduction due to the filter, or to increase the soft saturation of the effect.

## Legacy BR4

In order to remain backwards compatible, the filter designs from before Kontakt 5 are included with the tag Legacy. These are like the SV filters but use a much older algorithm. If you are planning to use clean filters, we advise you use the newer SV filters. The BR4 is a 4-pole band reject filter, which attenuates frequencies at the cutoff.



The Legacy BR4 module

## Multi

### SV Par. LP/HP

The State Variable (SV) filters have a clean characteristic that can be used for all kinds of audio signals. The Par. LP/HP is the combination of a highpass filter and a lowpass filter routed in parallel (ie. the signal is split and routed through each separately). The result is similar to a notch filter.

The SV Par. LP/HP filter contains the following controls:



The SV Par. LP/HP module

- **Cutoff:** Adjusts the central cutoff frequency of the two filters.
- **Reso.** (Resonance): Adjusts the amount of boost around the cutoff frequency of each filter.
- **B.Width** (Bandwidth): Controls the gap between the cutoff frequencies of the two filters, with the highpass filter's cutoff always above that of the lowpass. The gap is generated around a central point controlled by the Cutoff control.

### SV Par. BP/BP

The State Variable (SV) filters have a clean characteristic that can be used for all kinds of audio signals. The Par. BP/BP is a combination of two parallel bandpass filters.

The SV Par. BP/BP filter contains the following controls:



The SV Par. BP/BP module

- **Cutoff:** Adjusts the central cutoff frequency of the two filters.
- **Reso.** (Resonance): Adjusts the amount of boost around the cutoff frequency of each filter.
- **B.Width** (Bandwidth): Controls the gap between the cutoff frequencies of the two filters. The gap is generated around a central point controlled by the Cutoff control.

### SV Ser. LP/HP

The State Variable (SV) filters have a clean characteristic that can be used for all kinds of audio signals. The Ser. LP/HP is the combination of a high-pass filter routed serially after a low-pass filter. The result is similar to a band-pass filter.

The SV Ser. LP/HP filter contains the following controls:



The SV Ser. LP/HP module

- **Cutoff:** Controls the central cutoff frequency of the two filters.
- **Reso.** (Resonance): Controls the amount of boost around the cutoff frequency of each filter.
- **B.Width** (Bandwidth): Controls the gap between the cutoff frequencies of the two filters, with the lowpass filter's cutoff always above that of the highpass. The gap is generated around a central point controlled by the Cutoff control.

### 3x2 Versatile

The 3x2 Versatile Filter provides three separate filter bands, each of which can be continuously “morphed” between 3 characteristics (lowpass, bandpass, or highpass). Each filter band has a slope of 12 dB/octave. By combining these bands at various amounts, you can create almost every imaginable filter configuration. What’s more, the resonance controls of each filter band exhibit a behavior known from very high-quality analog filters: at high settings, the filter will begin to oscillate and produce sound, even if there’s no signal present at the input. This effect is known as self-oscillation. The 3x2 Versatile Filter requires more CPU power than other Kontakt filters, so use it only when you need this level of sophistication.

### 3 x 2 POLE MULTI-MODE FILTER

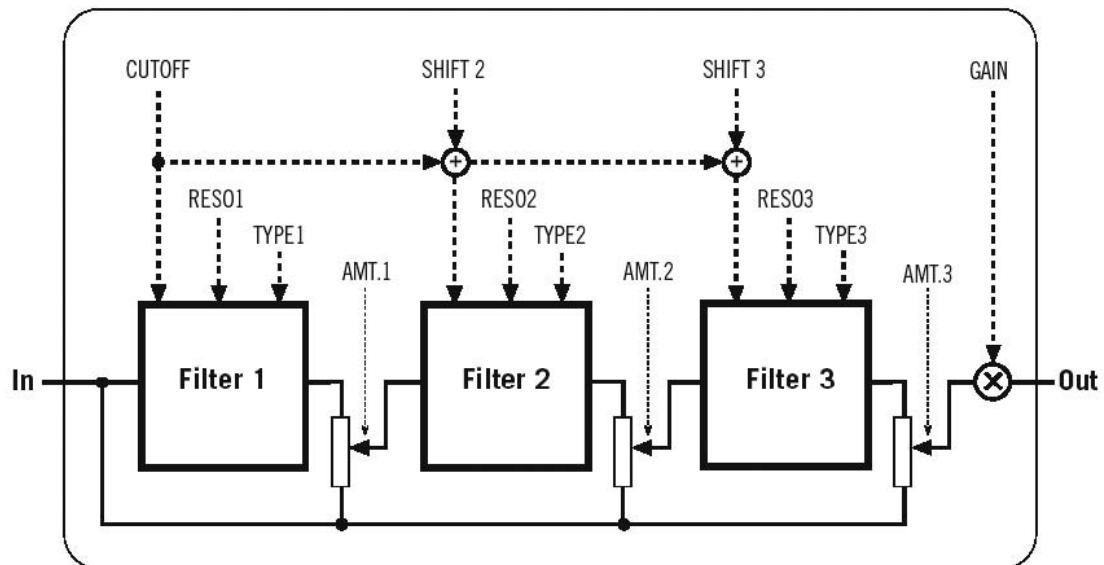

The basic internal signal flow structure of the 3x2 Pole Multi-Mode Filter

The 3x2 Versatile Filter contains the following controls:



The 3x2 Versatile module

- **Cutoff:** Adjusts the cutoff frequencies of the 3 filter bands in unison. The displayed value is only absolute for the first (topmost) filter band, the other two bands have cutoff frequencies relative to this one (see below).
- **Shift 2:** Adjusts the second filter band's cutoff frequency as an offset in relation to the first filter. With a value of 0, both filters will have identical cutoff frequencies, while increasing the value will set the second cutoff frequency higher than the first.
- **Shift 3:** Adjusts the third filter band's cutoff frequency as an offset in relation to the second filter.
- **Reso. 1 to Reso. 3 (Resonance):** Adjusts the resonance (boost at the cutoff frequency) for each filter band. Values of 98% or higher will result in self-oscillation.
- **Type 1 to Type 3:** Adjusts the characteristic of each filter band, allowing you to morph continuously between a lowpass (0.0), bandpass (0.5), or highpass (1.0) characteristic.
- **Amt. 1 to Amt. 3 (Amount):** Adjusts the amount to which each filter band will affect the overall result. At a value of 0, the respective filter will be inactive.
- **Gain:** As high resonance settings can significantly increase the signal level, Kontakt will automatically reduce the level the output level in such cases. You can compensate this with the Gain control, but be careful – it's easy to get excessive volume levels from this filter.

## Simple LP/HP

This very clean sounding filter lacks any pronounced resonance and is ideally suited for removal of low frequency rumble and high frequency issues like harshness and excessive noise without coloring the filtered signal.

The HP filter is a 2-pole (12 dB/octave), whereas the 1-pole LP has a more gentle slope of 6 dB/octave.



The Simple LP/HP Filter

- **Cutoff LP:** Controls the cutoff frequency of the Low Pass filter.
- **Cutoff HP:** Controls the cutoff frequency of the High Pass filter.

## Effect filters

Filters in this category don't match any of the traditional filter characteristics, and are thus better suited for special effects.

## Formant I

Formants are acoustic resonances. The term often applies to the phonetics of human speech, as such, the formant filters are designed to mimic the frequency response of the human vocal tract. These filters can be used to emulate the “talk box” effect.

The Formant I filter contains the following controls:



*The Formant I module*

- **Talk:** Controls the frequency response of the filter. Can be used to morph between vowel-sounds.
- **Sharp:** Increases and decreases the peaks and notches in the response respectively, analogous to the resonance control of the other filters.
- **Size:** Controls the center of the frequency response, analogous to the cutoff control of the other filters.

## Formant II

Formants are acoustic resonances. The term often applies to the phonetics of human speech, as such, the formant filters are designed to mimic the frequency response of the human vocal tract. These filters can be used to emulate the “talk box” effect.

The Formant II filter contains the following controls:



*The Formant II module*

- **Talk:** Controls the frequency response of the filter. Can be used to morph between vowel-sounds.
- **Sharp:** Increases and decreases the peaks and notches in the response respectively, analogous to the resonance control of the other filters.
- **Size:** Controls the center of the frequency response, analogous to the cutoff control of the other filters.

## Phaser

The Phaser creates a distinct comb filter effect by using an all-pass filter design that radically alters the phase relations in your signal. Note that there’s also a Phaser module in the standard effects section, which has a built-in modulation mechanism. While that module and the phaser filter share the underlying principle, the filter is better suited for timbral changes, while the Phaser effect module is recommended for creating the classic effect of the same name that can be found in countless effects processors and guitar stomp boxes.

Phaser contains the following controls:



The Phaser module

- **Cutoff:** Adjusts the center working frequency of the phaser's comb filter effect. Changing this parameter will alter the tonality of your sound in a distinct and not always easily predictable way.
- **Reso.** (Resonance): Adjusts depth and narrowness of the notches that the phaser imposes on the frequency spectrum, and thereby the intensity of the effect.

## Vowel A

This filter simulates the resonant frequencies of the human vocal tract; when forming a vowel, the throat and mouth cavities will change their shape in order to create a complex, natural filter which emphasizes certain frequencies in the sound created by the vocal chords. These characteristic frequencies, called formants, allow the human hearing to discern between different vowels, and are being replicated by this filter.

Vowel A contains the following controls:



The Vowel A module

- **Cutoff:** Adjusts the center frequency of the filter. Various distinct frequencies across the spectrum will produce different vowels.
- **Reso.** (Resonance): With values greater than 0, this control will emphasize the frequencies around the center frequency in order to create a sharper sound and enhance the effect.

## Vowel B

This filter works similarly to the Vowel A module, but has a slightly different sonic character.

Vowel B contains the following controls:



The Vowel B module

- **Cutoff:** Adjusts the center frequency of the filter. Various distinct frequencies across the spectrum will produce different vowels.
- **Reso.** (Resonance): With values greater than 0, this control will emphasize the frequencies around the center frequency in order to create a sharper sound and enhance the effect.

## Equalizers

Kontakt's fully parametric peak equalizers allow for a wide range of tonal alterations and corrections. Using up to three EQ bands per module, you can boost or cut any frequency range throughout the entire spectrum by up to 18 dB, with an adjustable Bandwidth parameter allowing you to choose between gentle corrections or very steep "surgical" edits.

The EQ module is available in 1-band, 2-band, and 3-band flavors. You can switch freely between these configurations without losing your settings.

All EQ bands contain the following controls:



*The EQ module*

- **Freq.** (Frequency): Adjusts the center frequency at which the boost or cut will occur.
- **Bandw.** (Bandwidth): Adjusts the width of the frequency range that will be affected in octaves.
- **Gain:** Adjusts the amount of boost (positive values) or cut (negative values) at the center frequency.

## Solid G-EQ

The Solid G-EQ differs from other Kontakt EQs as it is modelled on high quality analogue circuitry. It is a 4-band parametric EQ and offers the choice of bell or shelf style control of the low and high frequency bands.

The Solid G-EQ contains the following controls:



*The Solid G-EQ module*

- **HP Freq:** Adjusts the cutoff frequency of the highpass filter.
- **Highpass:** Toggles the highpass filter on or off.
- **LF Gain:** Adjusts the amount of boost or cut at the LF Frequency.
- **LF Freq:** Adjusts the center frequency of the low frequency band at which the boost or cut will occur.
- **LF Bell:** Toggles the bell shape of the low frequency band. If turned off the band becomes a shelf.
- **LMF Gain:** Adjusts the amount of boost or cut at the LMF Frequency.
- **LMF Freq:** Adjusts the center frequency of the low-mid frequency band at which the boost or cut will occur.
- **LMF Q:** Controls the Quality (or Q) of the low-mid frequency band. For most EQs, the higher the quality, the narrower the frequency band, but with this EQ the control is reversed to match the hardware it emulates and becomes a bandwidth control.
- **HMF Gain:** Adjusts the amount of boost or cut at the HMF Frequency.
- **HMF Freq:** Adjusts the center frequency of the high-mid frequency band at which the boost or cut will occur.

- **HMF Q:** Controls the Quality (or Q) of the high-mid frequency band. For most EQs, the higher the quality, the narrower the frequency band, but with this EQ the control is reversed to match the hardware it emulates and becomes a bandwidth control.
- **HF Gain:** Adjusts the amount of boost or cut at the HF Frequency.
- **HF Freq:** Adjusts the center frequency of the high frequency band at which the boost or cut will occur.
- **HF Bell:** Toggles the bell shape of the high frequency band. If turned off the band becomes a shelf.
- **Output:** Adjusts the overall output volume of the module.
- **LP Freq:** Adjusts the cutoff frequency of the lowpass filter.
- **Lowpass:** Toggles the lowpass filter on or off.



## 12. Effect reference

This section provides descriptions of all effects modules that are available in Kontakt Classic view, as well as explanations of their parameters. Effects include dynamics tools, such as compressors, as well as audio processors that change the signal in a usually non-linear way, such as reverbs, flangers or distortion effects.

You can access these modules by clicking on the **+** icon in the lower right corner of each effects slot, which opens a drop-down menu of available effects.

### Dynamics

Dynamic effects include the Compressor, Feedback Compressor, Limiter, Solid Bus Comp, Supercharger GT, Transient Master, and Transparent Limiter.

#### Compressor

Compressors are dynamic tools which reduce the level of loud passages in a signal, thereby affecting the signal's dynamic range. They are invaluable for a lot of common tasks — for instance, they can be used for reducing level peaks, thereby allowing the overall signal volume to be turned up without making it clip, or in other words, increasing the average volume of a signal. By careful adjustment of the attack and release times, they can also modify signal transients, allowing you to add punch to weak-sounding drums or taming exaggerated “clicking” in percussion sounds. However, there is a point of diminishing returns; too much compression can result in a rather strained and weak sound.

Compressor contains the following controls:



- **Mode:** Choose between Classic, Enhanced, and Pro mode. Each of these settings provides a different flavor of compression; if you feel you can't make a setting work with your sound, you should experiment with the other modes in this menu.
- **St.Link** (Stereo link): When activated, this causes the compressor to always act on the left and right channel in unison; this preserves the stereo image. When deactivated, the Compressor becomes a dual mono processor, which means that both channels will be processed independently.
- **Thresh:** Sets a level threshold above which the Compressor starts working. Only levels that rise above this threshold will be reduced by the compression; signals that stay below it will be left unprocessed.
- **Ratio:** Controls the amount of compression, expressed as a ratio of input level change against output level change. A Ratio of 1:1 results in no compression. A Ratio of 2:1 means that a level increase of 2 dB at the input will raise the output level by only 1 dB. A 4:1 Ratio results in more aggressive compression, with a 4 dB level increase at the input causing a 1 dB increase at the output.
- **Attack:** Adjusts the time the Compressor will take to reach the full Ratio value after an input signal exceeds the Threshold level. If you're using compression mainly for transparent dynamic reduction, values between 5 and 10 ms are a good starting point. Longer attack times can be useful for emphasizing transients and adding “punch” to a signal.

- **Release:** Adjusts the time the compressor will take to fall back to non-compression after the input signal falls below the threshold. Typical values range from 50 to 250 ms.
- **Output:** Controls the module's output level. This knob acts as a make-up gain control, which allows you to bring the output signal up to the same peak level as the input signal after compression. After you've found a compression setting, it's good practice to adjust the input and output signals so they have comparable levels, and then compare them via the **Bypass** button. This way, you can make sure your adjustment really made the signal sound better (and not just louder).

## Feedback Compressor

Compressors are dynamic tools that automatically reduce the level of loud passages in a signal, thereby affecting the signal's dynamic range. A feedback compressor is a type of compressor that compares the amplifier's output signal, rather than the input signal, to a threshold level. When the threshold level is reached, the compressor reduces the signal's gain level. The Feedback Compressor is modeled after a classic feedback compressor known for its bright and punchy sound.

Feedback Compressor contains the following controls:



- **High Quality:** Toggles oversampling within the effect, which can increase audio quality, but will also increase CPU load.
- **St. Link** (Stereo link): When activated, this causes the compressor to always act on the left and right channel in unison; this preserves the stereo image. When deactivated, the Feedback Compressor becomes a dual mono processor, which means that both channels will be processed independently.
- **Input:** Adjusts both the input level and the threshold simultaneously. Turning this knob clockwise will result in more compression.
- **Ratio:** Determines the amount of compression. 1.0 means no compression at all, while 2.0 means that a 2 dB increase at the input will raise the output by only 1 dB.
- **Attack:** Controls the scaling of the attack phase of the input signal's volume envelope. Increasing this parameter will add more punch and decreasing it will reduce sharp attacks.
- **Release:** Determines how long it takes for the compression action to stop after the input signal falls below the threshold level. Typical values range from 50 to 250 ms.
- **Makeup:** Controls the output gain of the compressed signal. Used to compensate for the gain reduction of the effect.
- **Mix:** Controls the dry/wet mix of the compressor. This can be used to create a parallel compression style routing, which increases the quieter signals rather than reducing the louder ones. At a setting of 100% you will only hear the compressed signal; at a setting of 0% you will only hear the unprocessed input signal.
- **Output:** Controls the module's output level.
- **Gain Reduction Meter:** The meter to the bottom right shows the amount of gain reduction in dB.

## Limiter

Limiters are actually a special form of compressors with a ratio of one to infinity, a threshold just below the maximum level, and a very short attack time. They act as a “safety net” to keep short signal peaks from overloading the system, which would result in audio clipping. While compressors have a range of artistic applications, limiters are usually used for technical reasons – they can tame signals with peaks which would otherwise overload the output, without requiring you to turn the signal’s overall volume down.

The Limiter contains the following controls:



- **In Gain:** Sets the gain of the input signal. The Limiter is different from the Compressor in that it has a fixed threshold; to achieve a sensible peak reduction, use this control to adjust the input gain until you see the Attenuation meter responding only to occasional level peaks.
- **Release:** Just like the Compressor’s control of the same name, this knob adjusts the time it takes the Limiter to return to an unprocessed signal after the input level falls below the threshold.
- **Attenuation:** This LED-style meter shows the amount of gain reduction that the Limiter imposes on the signal. Limiting works best if this meter responds only to occasional level peaks; if it indicates permanent action, it’s a sure sign that your In Gain is set too high. This can considerably degrade the quality of your signal.
- **Output:** Adjusts the module’s output level.

## Solid Bus Comp

Compressors are dynamic tools which automatically reduce the level of loud passages in a signal, thereby affecting the signal’s dynamic range. The Solid Bus Comp is modeled after a classic analog bus compressor. It offers a more characteristic dynamic control than Kontakt’s standard compressor.

Solid Bus Comp contains the following controls:



- **Link** (Stereo link): When activated, this causes the compressor to always act on the left and right channel in unison; this preserves the stereo image. When deactivated, the Compressor becomes a dual mono processor, which means that both channels will be processed independently.
- **Threshold:** Sets a level threshold above which the Compressor starts working. Only levels that rise above this threshold will be reduced by the compression; signals that stay below it will be left unprocessed.
- **Ratio:** Controls the amount of compression, expressed as a ratio of “input level change” against “output level change”. A Ratio of 1:1 means that no compression will be happening. For example, a Setting of 4 represents the ration 4:1, which means for every 4 decibel increase of amplitude above the threshold, the output will increase by only 1 decibel.

- **Attack:** Adjusts the time the Compressor will take to reach the full Ratio value after an input signal exceeds the Threshold level.
- **Release:** Adjusts the time the compressor will take to fall back to non-compression after the input signal falls below the threshold.
- **Makeup:** Controls the output gain of the compressed signal. Used to compensate for the gain reduction of the effect.
- **Mix:** Controls the dry/wet mix of the compressor. This can be used to create a parallel compression style routing, which increases the quieter signals rather than reducing the louder ones. At a setting of 100% you will only hear the compressed signal, at a setting of 0% you will only hear the unprocessed input signal.
- **Output:** Controls the module's output level.

## Supercharger GT

The Supercharger GT offers high-end tube compression emulation, inspired by boutique hardware. It is a particularly musical compressor, with different flavors of saturation and spectral shaping that allow you to apply subtle harmonic and spatial enhancement as well as heavy and aggressive tube drive.

Compressor tools affect both the dynamic range and color of a signal. They can be used for reducing level peaks, thereby allowing the overall signal volume to be turned up without clipping. They can also add coloration, character and warmth to a signal, which is especially inherent with tube-style compressors. Using Supercharger GT, you can stretch the decay phase of instruments, particularly drums, and add sustain to the tone of the electric guitars. Subtle compression applied to vocals helps to smoothen and balance their level within the mix. You can also try adding Supercharger GT to a Main Effects slot, and apply a slight amount of compression to your overall mix. Adding compression to the final signal path can add cohesion between various instruments, working like a glue that balances and binds sounds together.

Supercharger GT contains the following controls:



- **Input:** Adjusts the input gain to the compressor in dB. The ideal setting of the **Input** is indicated by the **Input Level Meter**.
- **Input Level Meter:** Displays the input level and indicates if the **Input** is set correctly. When the center LED lights up green, the **Input** level is at an ideal setting. If the **Input** level is too low, the left LED will light up red, and when it is too high, the right LED will light up red.
- **HP Detector:** Selects one of three options (off, 100Hz, 300Hz) that determine if a high-pass filter is applied to the input signal. When set to **100Hz** or **300Hz**, the high-pass filter will cut the input signal below the selected frequency. Use this to prevent the compressor from reacting to low frequency signal peaks as induced by kick drums or bass instruments. This is especially useful when you using the Supercharger GT on the Main Effects chain.
- **Saturation:** Applies saturation to the signal. Turn the control right to apply more saturation to the signal. The type of saturation is determined by the selected **Saturation Mode**.

- **Saturation Mode:** Selects from three modes (Mild, Moderate, Hot) that determine the type of **Saturation** applied to the signal. **Mild** mode adds coloration to the signal whilst retaining a clean sound. **Moderate** mode adds more noticeable harmonics, and **Hot** mode applies maximum saturation and produces audible distortion.
- **Compress:** Determines the amount of compression applied to the input signal. The higher the value, the more compression is applied to the input signal.
- **Gain Reduction Meter:** Displays the amount of gain reduction in dB.
- **Attack:** Determines how fast the compressor reacts to incoming signals. Increasing this parameter will add more punch and decreasing it will reduce sharp attacks.
- **Release:** Adjusts the length of compressor's **Release** phase, which determines how long it takes for the compression to stop after the input signal falls below the **Threshold** level. Typical values range from 50 to 250 ms.
- **Character:** Changes the sound characteristic of the compression effect by applying equalization to the signal. The type of equalization is determined by the selected **Character Mode**.
- **Character Mode:** Selects from three modes (Fat, Warm, Bright) that determine the type of equalization applied. **Fat** mode emphasizes low and high frequencies. **Warm** mode rolls off high frequencies, while enhancing the lower frequencies. **Bright** mode enhances high frequencies and attenuates the lower frequencies of the signal.
- **Channel Link:** Selects from three stereo modes (Stereo Link, Dual Mono, MS) that determine how the compressor is applied to the stereo channels. **Stereo Link** applies equal gain reduction to both the left and right channels. It is the most common mode as it eliminates the risk of shifting the stereo image. **Dual Mono** mode compresses each channel individually and can be used to widen the mix. In **MS** mode, the input signal will not be split into a left and right channel, but instead processed as mid and side signals. **MS** mode enhances the side signal to a certain extent, so signals processed using this mode may sound wider.
- **Mix:** Controls the dry/wet mix of the compressor. This can be used to create a parallel compression style routing, which increases the quieter signals rather than reducing the louder ones. When the **Mix** control is set to 0%, only the uncompressed (dry) signal will be heard, and at 100%, only the compressed signal will be heard. Settings between the 0% and 100% are a mix of both signals.
- **Output:** Sets the output level of the compressor in dB. You can use it as a make-up gain control that allows you to bring the output signal up to the same peak level as the input signal after compression. Once you have found a compression setting, it's good practice to adjust the input and output signals so they have comparable levels, and then compare them via the **Bypass** button. This way, you can ensure that the compressed signal sounds better, not just louder.

## Transient Master

The Transient Master is an easy to use compressor designed to control the attack and sustain of a sound. Instead of following the amplitude of the sound like a traditional compressor, it follows the general envelope and is thus not as susceptible to changes of input gain. It is best used on sounds with fast attacks, like percussion, pianos or guitars. The Transient Master can also be quite extreme in some cases, so use it with caution.

The Transient Master contains the following controls:



- **Smooth:** Transient Master is designed mainly to work on drums or percussive material, so certain input signals (for example: an acoustic guitar) may not work ideally in the default mode, so try switching this button on if you are encountering problems.
- **Input:** Controls the input gain to the effect.
- **Attack:** Adjusts the scaling of the attack portion of the input signal's volume envelope. Turning the knob right (0% to 100%) will add more punch, and turning the knob left (0% to -100%) will reduce sharp attacks.
- **Sustain:** Controls the scaling of the sustain portion of the input signal's volume envelope. Increasing this parameter will add more body to the sound and decreasing it will reduce the sound's tail.
- **Output:** Sets the output level of the effect in dB. For dynamic effects like compressors, this is very important.

## Transparent Limiter

The Transparent Limiter has two key functions; to ensure that the signal level stays below 0 dB, thus avoiding digital clipping, and to increase the overall perceived volume of the signal. Preventing digital distortion is a safety measure that is fulfilled best by a limiter, as you are able to set a maximum output level via the ceiling control. The Transparent Limiter is perfect for this task, acting as a final means of protecting your signal from clipping without imposing too much coloration to your sound.

Reducing the Threshold will reduce the dynamic range of the signal, allowing you to boost the overall volume using the Output control. However, setting the Threshold too low can result in a squashed and dull sound. For best results, experiment with the Threshold and Release controls to see what works best for your signal. It is recommended to use the Transparent Limiter in the Main Effects section, as a final processor on your signal chain.

The Transparent Limiter contains the following controls:



- **Threshold:** Sets the threshold at which the limiter begins to affect the input signal. To prevent the signal from clipping, leave the **Threshold** at 0 dB. To make the signal louder, reduce the **Threshold** value by turning the control to the left. The **Threshold** can be set in the range from -40.0 dB to 0.0 dB.
- **Release:** Adjusts the length of the release phase, which determines how long it takes for the limiter to stop after the input signal falls below the **Threshold** level. The **Release** can be set in the range from 1.0 ms to 500.0 ms.
- **Ceiling:** Sets the maximum output level of the limiter in dB. A value of -0.3 dB is recommended to avoid any potential distortion on playback. The **Ceiling** can be set in the range from -40.0 dB to -0.3 dB.
- **Gain Reduction Meter:** An LED style meter that displays the amount of gain reduction in dB. Limiting works best if this meter responds only to occasional level peaks; permanent gain reduction indicates that the Threshold is set too low.
- **Output:** Adjusts the limiter's output level in dB.

## Amplifiers

Amplifiers includes the ACBox, Bass Invader, Bass Pro, Cabinet, HotSolo, Jump, Twang and Van51 effects.

### ACBox

The ACBox models the guitar amplifier sound that powered the British Invasion of pop music. There were many versions of this highly original amp made, each having a different character. We chose a model that stands out with a unique flavor and includes the famous Top Boost channel!

The Normal channel has a treble **ToneCut** control while the Brilliant channel offers **Treble** and **Bass** controls.

ACBox contains the following controls:



- **Mono:** When this button is engaged, all channels of the input signal will be summed to a mono signal before being processed. When this button is not engaged, each channel is processed individually. Please note that this can increase the CPU load considerably.
- **NormVol:** Sets the level for the Normal channel. The Treble and Bass controls have no effect in this channel.
- **BrillVol:** Sets the level for the Brilliant channel.
- **TremSp:** Sets the rate of the tremolo.
- **TremDpt:** Controls the amount of tremolo applied. The effect is off when fully turned down.
- **Treble:** Adjusts the high frequency response for the Brilliant channel.
- **Bass:** Adjusts the low frequency response for the Brilliant channel.
- **ToneCut:** Controls a low-pass filter. By turning the knob clockwise treble in the output of the Normal channel is reduced.
- **Output:** Adjusts the module's output level.

### Bass Invader

The Bass Invader models the sound of a versatile amplifier associated with the Rock and Indie sound of the late 1980s and 1990s. It includes extensive tone shaping controls that allow you to precisely tailor the sound. Although its character can be described as clean and sweet for most of its range, it also produces very interesting distortion sounds when the controls are cranked up.

This amp has been modeled using NI's newly developed ICM (Intelligent Circuit Modeling) technology that employs machine learning to reproduce the behavior of hardware devices from the ground up, giving a whole new level of depth and realism to amp emulations.

The Bass Invader contains the following controls:





- **High Boost:** Boosts high frequency content, adding edge and definition to the sound.
- **Mid Contour:** Cuts low-mid frequency content, softening the sound.
- **Low Cut:** Cuts low frequency content, removing rumble from the sound.
- **Volume:** Adjusts the input level, or gain, of the amplifier. Turning Volume to the right adds saturation and distortion to the signal.
- **Boost:** Adjusts the amount of extra gain added to the signal.
- **Bass:** Adjusts the low frequency response.
- **Lo Mid:** Adjusts the low-mid frequency response.
- **Hi Mid:** Adjusts high-mid frequency response.
- **Treble:** Adjusts the high frequency response.
- **Master:** Adjusts the master volume of the amp.
- **Output:** Adjusts the output level of the effect.

## Bass Pro

The Bass Pro simulates a gritty and growling amplifier sound that makes the bass cut through the mix. It includes a graphic equalizer that allows you to precisely tailor your sound. This effect is available on both the Group and Instrument level.

The Bass Pro contains the following controls:



- **Bright:** Boosts high-frequency content.
- **Ultra Hi:** Boosts high-frequency content in a wide frequency range. The effect is more pronounced than the one achieved using Bright.
- **Ultra Lo:** Boosts low-frequency content and cuts mid-frequency content.
- **Mono:** When active, the module will work like a mono effect, causing stereo and multichannel signals to be summed to mono at its input. When inactive, each channel is processed separately. Note that disabling mono can increase CPU load considerably.
- **Graphic EQ:** Activates the graphic equalizer in the lower panel of the amplifier.
- **Graphic EQ Gain:** Boosts or cuts nine specific frequency bands: 40 Hz, 90 Hz, 180 Hz, 300 Hz, 500 Hz, 1 kHz, 2 kHz, 4 kHz, and 10 kHz. When a slider is centered, the respective frequency band remains unaffected. Moving a slider up boosts the respective frequency band by up to 12 dB. Moving a slider down cuts the respective frequency band by up to -12 dB.
- **Graphic EQ Volume:** Adjusts the output level of the graphic equalizer. Moving the slider up increases the level by up to 8 dB. Moving the slider down decreases the level by up to -10 dB. You can use this control to compensate for strong boosts or cuts made with the graphic equalizer.
- **Gain:** Adjusts the input level, or gain, of the amplifier. Turning Gain to the right adds saturation and distortion to the signal.
- **Bass:** Adjusts the low-frequency response.



- **Mid:** Adjusts mid-frequency content in a frequency band set using the Mid Freq control.
- **Mid Freq:** Sets the frequency band adjusted using the Mid control from 200 Hz to 3200 Hz.
- **Treble:** Adjusts the high-frequency response.
- **Drive:** Adjusts gain specifically for mid-frequency content, thereby changing the character of the sound.
- **Master:** Adjusts the master volume of the amp.
- **Output:** Adjusts the output level of the effect.

## Cabinet

The module simulates the sound of a guitar cabinet recorded through a microphone. By following a distortion effect (like the Screamer) with this module in your insert chain, you can simulate a complete guitar amp.

Cabinet contains the following controls:



- **Cabinet Type:** Allows you to choose the simulated cabinet model via the up and down buttons.
- **Size:** Adjusts the size of the simulated cabinet. Larger cabinets tend to have a more pronounced bass response, while smaller cabinets can sound thin and tinny.
- **Air:** Controls the level of early reflections in the room response, adding a sense of space to the sound.
- **TREB:** Boosts or cuts the level of the higher frequencies.
- **BASS:** Boosts or cuts the level of the lower frequencies.
- **Output:** Adjusts the module's output level.

## EP Preamps

A collection of amplifiers, including distinct models for various preamps, EQs and tremolo effects.

EP Preamps contains the following controls:



- **Drive Mode:** Selects between four different preamp models, each with distinct characteristics.
- **EQ Mode:** Selects between three different EQ models, each with distinct characteristics.
- **Tremolo Mode:** Selects between four different tremolo models, each with distinct characteristics. Synth mode enables the subsequent Wave Mode menu.
- **Wave Mode:** Selects one of five waveforms to be used for amplitude modulation (tremolo).
- **Drive:** Adjusts the preamp input level or gain.
- **Bass:** Adjusts the low frequency response of the EQ. When EQ Mode is set to Passive, this control is named **Bass (P)** and adjust the cutoff frequency of a high-pass filter instead.

- **Treble:** Adjusts the high frequency response of the EQ. This control is not available when EQ Mode is set to Passive.
- **Rate:** Adjusts the frequency or speed by which the tremolo effect modulates the amplitude of the signal.
- **Amount:** Adjusts the amount of amplitude modulation (tremolo) applied to the signal.
- **Width:** Adjusts the amount of stereo offset between left and right channel when applying amplitude modulation (tremolo) to the signal.
- **Mono:** When active, the module will work like a mono effect, causing stereo and multichannel signals to be summed to mono at its input. When inactive, each channel is processed separately. Tremolo will always work in stereo.
- **Output:** Adjusts the output level of the module in dB.

## HotSolo

A model of a guitar amplifier that is considered to be a modern classic. HotSolo employs two separate preamplifier channels and heaps of gain for a distinctly contemporary rock sound.

HotSolo contains the following controls:



- **Overdrive:** Switches between the Normal (when off) and Overdrive (when on) channels.
- **Mono:** When this button is engaged, all channels of the input signal will be summed to a mono signal before being processed. When this button is not engaged, each channel is processed individually. Please note that this can increase the CPU load considerably.
- **Bass:** Adjusts the low frequency response.
- **Mid:** Adjusts the midrange frequency response.
- **Treble:** Adjusts the high frequency response.
- **Presence:** Boosts the frequency response in the upper midrange.
- **NormPre:** Sets the preamp gain for the low gain channel.
- **OvrPre:** Sets the preamp gain for the high gain channel.
- **Master:** Controls the overall output level.
- **Depth:** Controls the low range frequency response in the power amp.
- **Output:** Adjusts the module's output level.

## Jump

The Jump effect simulates the classic tone of British guitar amplifiers. It is ideal for creating smooth, singing lead sounds. The Jump effect is available on both the Group and Instrument level.

Jump contains the following controls:



- **HiGain:** Increases the preamp's gain potential. Switch to **HiGain** mode if you want to create distinctly distorted or saturated sounds.
- **Mono:** When this button is engaged, all channels of the input signal will be summed to a mono signal before being processed. This happens regardless of the number of channels the input signal consists of, i.e. no matter whether it is a mono, stereo, or 5.1 signal. When this button is not engaged, each channel is processed individually. Please note that this can increase the CPU load considerably.
- **PreAmp:** Sets the amount of gain added by the preamp. Turning it clockwise adds drive, distortion and edge to the sound.
- **Master:** Adjusts the amp's master volume.
- **Bass:** Adjusts the low frequency response.
- **Mid:** Adjusts the midrange frequency response.
- **Treble:** Adjusts the high frequency response.
- **Presence:** Boosts the frequency response in the upper midrange.
- **Output:** Adjusts the module's output level.

## Twang

The Twang effect simulates the rich tube sound of classic guitar amps from decades ago. It's ideal for screaming leads and crunchy rhythm guitar sounds, as well as clean sounds with personality.

Twang contains the following controls:



- **Bright:** A tonal option which increases the high frequency content of the signal.
- **Polyphonic:** If this button is inactive, the Twang module will work as a mono effect, which causes stereo signals to be summed to mono at its input; when active, the effect operates on each input channel separately.
- **Volume:** Controls the input level. In contrast to the Output knob, which merely adjusts the overall level of the module, this knob works like the gain control of a guitar amp and affects the amount of distortion.
- **Treble, Mid** and **Bass:** These controls adjust the respective levels of the signal's high, midrange, and low frequency components.
- **Output:** Adjusts the module's output level.

## Van51

One of the benchmarks in high gain amplifiers. Van51 delivers a wide range of raw and edgy in your face guitar tones. The Van51 effect is available on both the Group and Instrument level.

V51 contains the following controls:



- **LeadChannel:** Switches between Rhythm (when inactive) and Lead (when active) channels.
- **HiGain:** Toggles between normal and high gain amplification.
- **Bright:** When active, this adds high frequency boost in the Rhythm channel.
- **Crunch:** Adds a large amount of distortion in the Rhythm channel.
- **Mono:** When this button is engaged, all channels of the input signal will be summed to a mono signal before being processed. When this button is not engaged, each channel is processed individually. Please note that this can increase the CPU load considerably.
- **Rhythm:** Controls the amount of preamp overdrive of the Rhythm channel.
- **Bass:** Adjusts the low frequency response.
- **Middle:** Adjusts the mid frequency response.
- **Treble:** Adjusts the high frequency response.
- **Lead:** Controls the amount of preamp overdrive of the Lead channel.
- **Post Gain:** Controls the master volume of both channels and the poweramp saturation.
- **Presence:** Boosts the frequency response in the upper midrange.
- **Reso:** Controls the low range frequency response in the poweramp.
- **Output:** Adjusts the module's output level.

## Stomps

Stomp effects include the Cat, Cry Wah, Distortion, DStortion, Lo-Fi, Saturator, Skreamer and Tape Saturator.

## Big Fuzz

Big Fuzz models the sound of a classic distortion pedal suitable for 1970s Rock guitars. Its sound character is dirty with a lot of grunge.

Big Fuzz contains the following controls:



- **Mono:** When active, the module works like a mono effect, causing stereo signals to be summed to mono at the input. When inactive, each channel is processed separately.
- **Sustain:** Adjusts the input level, or gain. Turning the control to the right increases the intensity of the distortion.
- **Tone:** Adjusts the frequency response. Turning this control to the left emphasizes high frequencies. Turning it to the right emphasizes low frequencies.
- **Bass:** Adjusts the low frequency gain.
- **Bright:** Adjusts the high frequency gain.
- **Output:** Adjusts the module's output level.

## Cat

Cat simulates a guitar distortion pedal, ideal for blues and rock tones.

Cat contains the following controls:



- **Mono:** When this button is engaged, all channels of the input signal will be summed to a mono signal before being processed. This happens regardless of the number of channels the input signal consists of, i.e. no matter whether it is a mono, stereo, or 5.1 signal. When this button is not engaged, each channel is processed individually. Please note that this can increase the CPU load considerably.
- **Volume:** The master volume control for the effect.
- **Filter:** For a darker sound, turn clockwise to enhance the low frequency range; turn counter-clockwise for a brighter, sharper sound.
- **Distortion:** Controls the amount of distortion applied.
- **Balls:** Adds low-end punch. Turning it counter-clockwise creates a flatter, more biting sound.
- **Bass:** Adjusts the low frequency response.
- **Treble:** Adjusts the high frequency response.
- **Tone:** Adjusts the frequency range influenced by the built-in pre-distortion midrange booster.
- **Output:** Adjusts the module's output level.

## Cry Wah

The Cry Wah has been imported from Guitar Rig 5 and is based on the most popular wah-wah of all time. This module creates a unique resonant peak that can be swept across the frequency spectrum using the Pedal control.

Cry Wah contains the following controls:



- **Pedal:** The pedal control is used to control the wah-wah frequency. Decreasing the value will lower the frequency and increasing the value will raise the frequency.
- **Mono:** If active, the module will work like a mono effect, which causes stereo signals to be summed to mono at its input. If inactive, it processes each channel separately.
- **Output:** Use this control to make up gain from the clipping caused by the wah-wah effect.

## Dirt

Dirt carefully provides more sophisticated and extreme sounds than possible with common distortion pedals, while staying true to the ease of use associated with these effects.

It consists of two circuit-modeled diode clipping stages (**A**, **B**) that can be configured in series or parallel using the Routing control. There are three modes of distortion (**I**, **II**, **III**) which can be used independently on each stage of the effect to set the type of clipping behavior. This allows you to explore different distortion characteristics and tonal qualities from subtle to more extreme.

The **Drive** control combined with the **Amount** control allow you to gradually increase the amount of saturation or distortion added to the signal. If the Amount control is increased beyond center position, the signal is folded back into itself, causing a more extreme distortion effect that adds strong harmonic overtones to the sound. By combining high settings for **Drive** and **Amount** on both stages, very rich and sustained sounds can be created by adding dirt and compression to the signal.

The distortion effect of each stage can be further adjusted using the **Tilt** control for filtering, and the **Bias** control for adding asymmetric behavior to the circuit, controlling the amount of even harmonics. Finally, when used in series the **Mix** control allows you to blend the dry and distorted signal to suit your mix, whereas in parallel mode the **Blend** control allows you to blend between the two stages **A** and **B**.

Dirt includes the following controls:

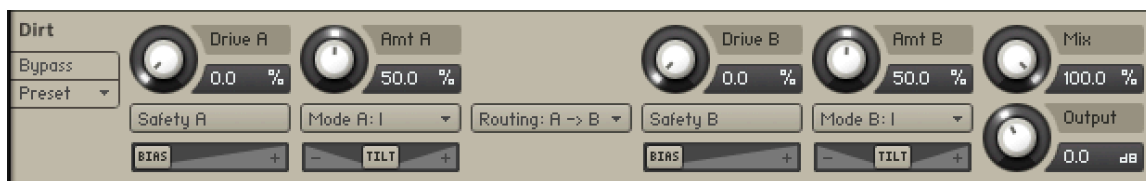

- **Safety A/B:** Switches off the gain compensation that keeps consistent loudness levels. This can be used, for example, to drive a signal into the second stage at higher distortion levels.
- **Drive A/B:** Adjusts the input level, or gain. Turning **Drive** to the right increases the intensity of the distortion.
- **Mode A/B:** Selects one of three distortion modes to be used independently on stage **A** and stage **B**:
  - **I** is the most subtle mode and adds the least amount of coloring to the audio signal.
  - **II** is the default mode and is a well-balanced type of distortion with the brightest tone.
  - **III** is the most extreme mode which adds a crushed type of distortion with a dark tone.
- **Amount A/B:** Adjusts the amount of distortion by introducing saturation in the first half of its range and wave folding in the second half. Instead of clipping the signal, wave folding folds the waveform of the signal back into itself.
- **Bias:** Introduces asymmetry into the signal by adding asymmetric behavior to the circuit, which produces even harmonics. This prevents the distorted audio from sounding hollow.
- **Tilt:** Applies filtering to the distorted signal. When turned to the right, low-frequency content is attenuated and high-frequency content is boosted. When turned to the left, low-frequency content is boosted and high-frequency content is attenuated.
- **Routing:** Determines how the signal is routed between stage **A** and stage **B** of the effect.
  - **A > B** serial routing configuration: The signal is fed into stage **A**, then into stage **B**.
  - **A < B** serial routing configuration: The signal is fed into stage **B**, then into stage **A**.
  - **A + B** parallel routing configuration: The signal is split into both stage **A** and stage **B** before being mixed with the **Blend** control.
- **Mix:** Blends between the dry signal and the wet signal by means of an equal-power crossfade. In **A + B** parallel routing configuration **Mix** is replaced with the **Blend** control, allowing you to blend between the output signals of stage **A** and stage **B**.
- **Output:** Sets the output of the module in dB.

## Distortion

This module causes distortion by clipping or rounding off high sample values. It thereby simulates the behavior of overloaded transistor or tube circuits, adding artificial harmonics to a sound.

Distortion contains the following controls:



- **Mode menu:** Selects between either Tube or Transistor characteristics. Tube distortion creates a smooth saturation, which emphasizes even harmonics, while the Transistor setting generates odd harmonics that create a harsher-sounding clipping effect.
- **Drive:** Adjusts the amount of distortion.
- **Damping:** Turning this knob clockwise attenuates high frequencies in the output signal, thereby counteracting the brightness caused by the artificial harmonics.
- **Output:** Adjusts the module's output level. Since distortion boosts the gain considerably, it's often necessary to attenuate the signal at the output stage.

## DStortion

An emulation of a classic guitar distortion effect pedal.

DStortion contains the following controls:



- **Mono:** When this button is engaged, all channels of the input signal will be summed to a mono signal before being processed. When this button is not engaged, each channel is processed individually. Please note that this can increase the CPU load considerably.
- **Volume:** The main volume control for this effect.
- **Tone:** turning this control clockwise accents the midrange while dropping the bass. Counterclockwise takes off the highs and boosts the bass for a warmer sound.
- **Drive:** adds dirt to the sound.
- **Bass:** Adjusts the low frequency response.
- **Mid:** Adjusts the midrange frequency response.
- **Treble:** Adjusts the high frequency response.
- **Output:** Adjusts the module's output level.

## Fuzz

Fuzz models the sound of a 1960s fuzz pedal suitable for harmonically rich lead guitars that cut through the mix. Additionally, it can be used for buzzing vintage rhythm guitar.

Fuzz contains the following controls:





- **Mono:** When active, the module works like a mono effect, causing stereo signals to be summed to mono at the input. When inactive, each channel is processed separately.
- **Amount:** Adjusts the input level, or gain. Turning the control to the right increases the intensity of the distortion.
- **Bass:** Adjusts the low frequency gain.
- **Bright:** Adjusts the high frequency gain.
- **Output:** Adjusts the module's output level.

## Saturator

This module is basically an amplifier with a non-linear characteristic. It allows you to recreate the effect of tape saturation, which causes an increase of high-level energy in your signal.

The Saturator contains the following controls:



- **Mode menu:** Select the saturation type: Classic, Enhanced or Drums. **Classic** is the original Kontakt algorithm, **Enhanced** is a higher quality saturation mode and **Drums** is the saturation model used by Maschine.
- **Saturation:** Adjusts the transfer curve. A negative setting results in a characteristic that will expand the signal – lower sample values will be attenuated, higher values will be amplified. Positive settings do the opposite and thusly simulate the compression-like saturation of an analogue circuit. At a value of 0.0, the signal will pass the module unprocessed.
- **Output:** Adjusts the Saturator's output level.

## Skreamer

This module offers an alternate overdrive algorithm that sounds warmer and smoother than the Distortion effect.

Skreamer contains the following controls:



- **Tone:** Controls the brightness of the sound. Turning this knob clockwise will result in a more pronounced top-end, which works great on bright, screaming leads and biting rhythms. Turning it counter-clockwise results in a mellower, darker sound.
- **Drive:** Adjusts the amount of distortion.
- **Bass:** Adjusts the low frequency gain.
- **Bright:** Adjusts the high frequency gain.
- **Clean:** Blends clean signal into the distorted tone. At **0.0 %**, only the distorted signal is audible, while at **100.0 %**, equal amounts of distorted and clean signal are mixed.



- **Output:** Adjusts the module's output level.

## Lo-Fi

Lo-Fi and and Bite both degrade the audio quality of the signal in unique ways.

### Bite

Bite is an anti-aliased sample rate and bit reduction effect that can be used to create distortion effects that sound like vintage studio equipment, or inherently lo-fi sound sources, like old video games. It simulates the audio being sampled and replayed using a low-quality sampler with limited sample rate and bit depth.

Bite is divided into two sections that control the resampling frequency (**kHz**) and the bit depth (**Bits**). As a special feature, the **Crunch** control adjusts the level going into the bit reduction algorithm, providing a smooth way to control the resolution without stepping effects.

The resampling algorithm also includes stereo clock jittering (**Jitter**), and the bit reduction algorithm provides stereo dither noise (**Dither**), allowing you to create a wide stereo image from any source. The additional controls for filtering and saturation allow you to fine-tune the behavior of the effect.

Bite contains the following controls:



- **Freq:** Adjusts the sampling frequency at which the input signal is resampled in a range of 0.1 kHz to 44.100 kHz.
- **Jitter:** Adjusts the amount of clock jitter. This adds fluctuations to the sampling rate of the resampling algorithm, effectively making the signal noisier. The jitter is added to the left and right stereo channels independently, resulting in a wide stereo image for the noise component.
- **Pre Filt:** Adjusts the cutoff frequency of a low-pass filter that is applied to the input signal. You can use it to remove frequencies that would produce aliasing noise in the resampling algorithm. At center position, the cutoff frequency is half of the sampling frequency. Its range is from 50 Hz to 22050 Hz.
- **Post Filt:** Adjusts the cutoff frequency of a low-pass filter that is applied to the output signal. You can use it to remove aliasing noise. At center position, the cutoff frequency is half of the sampling frequency. Its range is from 50 Hz to 22050 Hz.
- **HP:** Adjusts the cutoff frequency of a 1-pole high-pass filter that is applied to the output signal. It aims remove low-frequency and DC components from the signal. It provides three cutoffs 5 Hz, 100 Hz and 200 Hz.
- **Saturate:** Drives the quantized signal into a saturator and compensates for the loudness increase caused by the saturation.
- **Bits:** Adjusts the amounts of quantization values by setting the bit depth between 2 and 16 bits. Each sample is quantized to the set values. A lesser amount of values results in a more distorted sound.

- **Crunch:** Provides continuous control over the bit reduction effect, reducing the amount of used quantization values by lowering the signal level before the bit reduction algorithm. This allows you to smoothly control the resolution without stepping effects.
- **Dither:** Adjusts the amount of noise that is added to the resampled signal to reduce distortion caused by quantization errors. In this effect, the noise amount can be increased for creative purposes. Independent noise sources are used for left and right stereo channels, resulting in a wide stereo image for the noise component.
- **Expand:** Changes the distribution of the quantization values in the amplitude range. When set fully to the left, low-level signals are quantized at a higher resolution. When set fully to the right, the resolution available for quantizing low-level signals is reduced, effectively turning them into pulse waves.
- **DC:** Toggles between two different modes for the quantization of the input signal according to the bit depth (**Bits**). When activated, the zero level is removed from the available bit values, effectively sustaining the sound with a buzzing square wave. When deactivated, the output signal fades to silence immediately.
- **Mix:** Blends between the dry signal and the wet signal by means of an equal-power crossfade.
- **Output:** Adjusts the output level of the module in dB.

## Lo-Fi

This module adds various digital artifacts, like quantization noise or aliasing, to a clean signal. It's great for roughing up sounds that would otherwise be too plain and featureless.

LoFi contains the following controls:

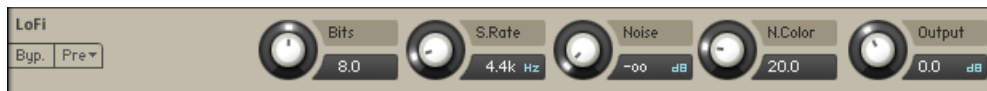

- **Bits:** Re-quantizes the signal to an adjustable bit depth. Fractional bit levels (such as 12.4 bits) are possible and can add considerable "grit". Audio CDs have a quantization depth of 16 bits, old samplers frequently used 8 or 12 bits, and 4 bits evoke memories of countless irritating children's toys.
- **S.Rate** (Sample Rate): Re-samples the signal to an adjustable sample rate. The re-sampling is done without any kind of (usually mandatory) low-pass filtering, which causes all kinds of wonderful aliasing artifacts. The sample rate goes all the way down to 50 Hz, which will not leave much of the original signal.
- **Noise:** Adds hiss to the audio signal.
- **N.Color:** Adjusts the frequency characteristic of the noise and acts as a low-pass filter.
- **Output:** Adjusts the module's output level.

## Tape

### Tape Saturator

The Tape Saturator emulates the soft compression and distortion of recording to tape. It can be used lightly to add warmth and coloring to the sound, or heavily to add aggressive distortion.

The Tape Saturator contains the following controls:

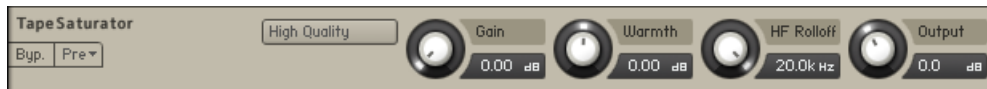

- **High Quality:** Toggles oversampling within the effect, which can increase audio quality, but will also increase CPU load.
- **Gain:** Controls the input gain of the effect. This will increase the amount of tape distortion and compression.
- **Warmth:** Controls the low frequency boost/cut of the effect.
- **HF Rolloff:** Controls the high frequency rolloff starting frequency. Frequencies above this point will be attenuated.
- **Output:** Controls the output gain of the effect.

## Wow/Flutter

Wow/Flutter emulates the sound of analog tape machines, characterized by wow and flutter, saturation, noise, and a limited high-frequency response. You can use it to apply classic lo-fi effects, particularly when playing sustained notes, pads and melodies.

Dedicated controls for **Wow**, **Flutter**, as well as the **Speed** and **Age** of the tape enable you to adjust the effect in great detail. The **Scrape** control expands the sound palette by degrading the sound and adding a crunchy quality.

Wow/Flutter includes the following controls:



- **Scrape:** Adjusts the amount of high-frequency scraping, which occurs when the tape vibrates as it passes over the playback head.
- **Wow:** Adjusts the amount of wow, a slow fluctuation in pitch caused by sticky tape and worn-out tape transport.
- **Flutter:** Adjusts the amount of flutter, a fast fluctuation in pitch caused by a bent capstans and faulty motor parts.
- **Speed:** Adjusts the rate of the wow and flutter modulation.
- **Stereo:** Adjusts the stereo width of **Wow** and **Flutter** by adding a phase offset to the modulation applied to the the left and right stereo channels.
- **Age:** Enhances the characteristics of an aging tape by reducing high-frequency content and introducing tape hiss.
- **Gate:** Toggles the noise gate on or off. When enabled it will remove low level tape hiss noise one second after receiving the last input signal.
- **Saturate:** Adjusts the amount of tape saturation from a clean sound to overdrive.
- **Mix:** Blends between the input signal and the effect signal by means of an equal-power crossfade.
- **Output:** Sets the output of the module in dB.

## Modulation

Modulation effects include the Choral, Flair, Phasis, Rotator, Legacy Chorus, Legacy Flanger and Legacy Phaser.

### Choral

Choruses are used to enrich sounds by adding spatial movement and giving them an ensemble-like quality. They are based on short delays, with built-in modulation of the delay time. The delays produce copies of the original sound that vary in timing and, as a side-effect of the delay time modulation, pitch. This way a chorus adds space and body to the sound as if it was played from multiple sources at the same time. The results range from subtle shifts in timbre to extremely lively textures with a wide stereo image.

As one of the most commonly used guitar and studio effects, various implementations of the chorus have found their way into studio rack processors, guitar pedals, and synthesizers. Choral is inspired by synthesizers and studio rack processors from the seventies and early eighties. On these devices, the chorus parameters are hidden. Choral gives you enhanced control with parameters that allow you to customize the effect with minimal effort.

Choral features four distinct chorus modes, ranging from the subtle sound of classic studio rack processors to the large ensemble sound of early string synthesizers. The effect is produced by up to three pairs of delays, called **Voices**. All chorus voices preserve the input signal's stereo image, but can also be panned to further widen the sound (**Width** parameter). The internal modulation system affects each voice differently, thus preventing obvious modulation repeats. Further expanding on the original concept of a chorus, the **Scatter** mode allows you create reverb-like sounds, avoiding the metallic quality that many choruses exhibit with high **Feedback** settings.

Choral contains the following controls:



- **Rate:** Adjusts the speed of modulation, from slow pitch changes to fast vibratos. This becomes more pronounced as **Amount** is increased.
- **Mode:** Switches between four chorus modes (Synth, Ensemble, Dimension, Universal), that determine the sound characteristic and modulation behavior.
  - **Synth:** This mode is inspired by the choruses of polyphonic synthesizers from the late seventies and early eighties. Its sound characteristic is dark and vintage. The modulation behavior is tuned for rich and dispersed sounds.
  - **Ensemble:** This mode is inspired by the choruses of string synthesizers from the seventies. Its sound characteristic is warm and lush. The modulation behavior is tuned for animated and lively sounds.
  - **Dimension:** This mode is inspired by the choruses of studio rack processors from the early eighties. Its sound characteristic is bright and transparent. The modulation behavior is tuned for wide and consistent sounds.
  - **Universal:** This mode is a more generic chorus implementation. Its sound characteristic is clean and modern. The modulation behavior is tuned for a range of sounds from consistent to lively, depending on the number of **Voices**.

- **Amount:** Adjusts the amount of modulation applied to the **Delay**, altering the delay times of the chorus voices. Due to the configuration of the delays, this also changes the pitch of the chorus voices, creating the typical chorusing effect.
- **Voices:** Fades from one to three chorus voices. Increasing the number of chorus voices adds a dense and ensemble-like quality to the sound. The modulation affects the second and third chorus voice differently from the first, resulting in a wider and livelier sound.
- **Delay:** Adjusts the delay times of the chorus voices, allowing you to change the spatial depth of the sound. This parameter strongly interacts with **Feedback**.
- **Width:** Pans the chorus voices in opposite directions, widening the stereo image. When **Width** is set to 0, the stereo image of the input is preserved.
- **Feedback:** Adjusts the level of the feedback signals from the outputs of the chorus voices to their inputs, creating a more sustained and spacious sound.
- **Scatter:** Enables a special feedback routing for the chorus voices that introduces reverb-like behavior.
- **Mix:** Blends between the input signal and the effect signal by means of an equal-power crossfade.
- **Invert:** Changes the sound characteristic of the chorusing effect by inverting the effect signal.
- **Mix:** Blends between the input signal and the effect signal. When the knob is turned fully left, only the dry input signal is heard.
- **Output:** Adjusts the module's output level.

## Flair

Flangers are used to enrich sounds by adding distinct harmonic effects that can completely transform a sound. They are based on comb filters, with built-in modulation of the comb filter frequency. A comb filter consists of an extremely short delay with feedback that produces harmonically related peaks and notches in the frequency spectrum. This way a flanger adds dramatic filtering effects and resonances to the sound. The results range from metallic textures to the warped sound of a starting jet engine.

As one of the most commonly used guitar and studio effects, various implementations of the flanger have found their way into studio rack processors and guitar pedals. Flair is a new take on the concept with additional features that have been carefully chosen to allow for more sophisticated and extreme sounds than possible with common flangers, while staying true to the ease of use and clarity associated with these devices.

Flair features three flanger modes that offer different approaches to a range of effects from flanging to harmonization. The effect is produced by up to four comb filters, called Voices. Further expanding on the original concept of a flanger, the flanger voices have a harmonic relationship based on a wide selection of preset chords (**Chord** parameter). In both Standard and Thru Zero mode, the flanger voices are added to form a chord, while in Scan mode, one flanger voice is blended into the next, generating a sequence similar to an arpeggiator on a keyboard. Especially with high feedback settings, this can lead to unusual results that are more akin to the sounds of a tuned resonator than a flanger.

Flair contains the following controls:



- **Mode:** Switches between three flanger modes (Standard, Thru Zero, Scan):
  - **Standard:** In this mode, each flanger voice behaves like a basic flanger effect, creating harmonically related peaks and notches in the frequency spectrum.
  - **Thru Zero:** In this mode, each flanger voice is duplicated. The duplicated instances of the flanger voices are excluded from the modulation and thus rest at their respective base pitch. When modulation is introduced by increasing **Amount**, the flanger voices shift against the duplicated instances in time. This creates the strong thru zero flanging effect with its characteristic signal cancellation, similar to the flanging effect originally created with two tape machines.
  - **Scan:** In this mode, instead of adding the flanger voices to form a chord, **Voices** scans through them one after the other. This is similar to how an arpeggiator on a keyboard plays the notes contained in a chord as a sequence. The Scan Mode selector below the Mode menu allows you to choose from three different waveforms for the modulation: Triangle, Sawtooth Up, and Sawtooth Down.
- **Offset:** Adds a frequency shift to the duplicated flanger voices in **Thru Zero** mode, changing their position relative to the center of modulation. This results in rhythmical variations of the flanging effect. Offset also enables you to reduce the amount of signal cancellation when there is no modulation (**Amount** set to 0%).
- **Chord:** Sets a chord that defines the harmonic relationship between the four **Voices**.
- **Invert Phase:** Swaps the position of the peaks and notches in the frequency spectrum by inverting the effect signal. When activated, the perceived pitch of the flanger voices is one octave lower. In **Thru Zero** mode, enabling Invert creates strong signal cancellations at the center of modulation, which can lead to interesting rhythmical effects.
- **Rate:** Adjusts the frequency of the modulation applied to **Pitch**. The modulation effect becomes more pronounced as **Amount** is increased. When **LFO Sync** is activated, modulation is synchronized to the host and the **Rate** knob is replaced by the **LFO Sync** controls: The Numerator (a) and Denominator (b) set the speed of modulation in musical notes relative to the host tempo. The Numerator sets the number of notes, while the Denominator sets the note value. The Sync Mode (c) sets the time value, or subdivision, for the chosen note value. For example, **1|4** in Sync Mode **Straight** means that the modulation repeats its cycle after one quarter note, and **3|2** in Sync Mode **Triplet** means that the modulation repeats its cycle after three half note triplets.
- **Feedback:** Adjusts the level of the feedback signals from the outputs of the flanger voices to their inputs, creating a more resonant and metallic sound.
- **Amount:** Adjusts the amount of modulation applied to **Pitch**, adding movement to the flanging effect.
- **Width:** Duplicates the flanger voices internally and pans them in opposite directions. A wide and lively stereo image is created by adding a phase offset to the modulation applied to **Pitch** between the left and right stereo channels. Additionally, a special type of cross-feedback is introduced, further animating the stereo image as **Feedback** is increased.
- **Pitch:** Adjusts the fundamental frequency of the first flanger voice in semitones, effectively shifting the peaks and notches of all flanger voices in the frequency spectrum.
- **Damping:** Attenuates the high frequency content of the feedback signals from the outputs of the flanger voices to their inputs, allowing for soft sounds even at high **Feedback** settings.
- **Voices:** When **Mode** is set to **Standard** or **Thru Zero**, **Voices** fades from one to four flanger voices. The additional flanger voices are added in harmonic intervals, forming a chord as set with **Chord**. When Mode is set to Scan, **Voices** scans through the four flanger voices one after the other by blending between the first and the second flanger voice, then the second and the third flanger voice, and so on.

- **Detune:** Alters the pitch of each individual flanger voice in a range of approximately +/- 60 cent. This creates a rich and lively sound similar to the effect of detuning oscillators on a synthesizer. Detune is especially useful when **Chord** is set to Unison.
- **Mix:** Blends between the input signal and the effect signal. When the knob is turned fully left, only the dry input signal is heard.
- **Output:** Adjusts the module's output level.

## Freak

Freak combines different amplitude modulation techniques and is based on a model of an analog diode ring circuit that produces rich harmonic overtones and textures. In addition to a wide range of harmonic transformations, its three FX Modes facilitate special applications like AM radio simulation (**Radio** mode), tremolo and distortion (**Oscillator** mode), as well as gating (**Sidechain** mode).

In all three FX Modes the **Type** control smoothly morphs between basic amplitude modulation (0%), ring modulation (50%), and frequency shifting (100%), while **Harmonics** and **Feedback** allow you to control the intensity of the effect. **Mix** blends between the dry and the wet signal and **Output** controls the volume of the module in dB. The controls on the left side are specific to each individual mode and are described in detail below.

Displayed here is Freak in Oscillator mode.



In Radio mode, Freak emulates the behavior of so-called demodulation circuits in old AM radios, allowing you to create the effect “of dialing in the frequency of a specific radio station. This emulation complements the amplitude modulation techniques available via the **Type** control. This mode uses a sine wave signal as the modulation source.

- **Tuning:** Emulates the effect of tuning an old AM radio. In center position, the best possible tuning is achieved. As you move the control away from center position, the amount of radio interference increases.
- **Demod:** Switches between emulations of two different demodulation circuits. When activated, a product demodulation circuit is used, producing an aggressive sound. When deactivated, an envelope demodulation circuit is used, recreating the sound of an old AM radio.
- **Width:** Adjusts the amount of filtering applied to the signal by changing the bandwidth of the band-pass filter used in the demodulation circuit. Low settings result in a filtered and slightly resonant sound. High settings reduce the filtering effect while adding more noise to the signal.
- **Carrier:** Adjusts the frequency of the carrier used in the demodulation circuit, controlling the quality of the radio transmission. The quality improves as you increase the frequency.
- **Gate:** Switches the noise gate on or off. When activated, noise from the demodulation circuit is only passed through if an input signal is present. When deactivated, the noise is constantly passed through, allowing you to use Freak as a flexible noise source. The amount of noise can be adjusted with the **Feedback** control.

In Oscillator mode, you can explore the pure sound of the three different amplitude modulation techniques available via the **Type** control. This modes uses a sine wave signal as the modulation source.



- **Freq:** Adjusts the rate of the internal sine wave modulation used by the three different amplitude modulation techniques available via the **Type** control. When **Type** is set to amplitude (0%) and ring (50%) modulation, this allows you to change the frequency of the sidebands created in the frequency spectrum. When **Type** is set to frequency shifting (100%), the modulation rate equals the amount by which the input signal's frequency content is shifted in the frequency spectrum. The **Freq** control is bipolar, meaning that both positive (non-inverted) and negative (inverted) modulation can be applied. The range of the **Freq** control can be set with the Range button.
- **Wide Range:** Sets the range of the **Freq** control. When activated, **Freq** has a coarse range of -5000 Hz to +5000 Hz. When deactivated, **Freq** has a fine range of -200 Hz to +200 Hz. This gives you full control over applications that require fine adjustment of the modulation rate below the audio spectrum (< 20 Hz).
- **Stereo:** Creates a wide stereo image by adding a phase offset to the modulation applied to the left and right stereo channels.
- **Antifold:** Reduces the amount of sidebands folding over 0 Hz, producing a cleaner sound in the low-frequency spectrum. By increasing **Antifold**, thinner sounding distortion effects with a less tonal quality can be achieved.

Sidechain mode opens up the amplitude modulation techniques available via the **Type** control for experimentation with a variety of modulation sources. It is possible to modulate the input signal with itself, or to use any external signal as the modulation source by feeding it into the plug-in's sidechain input. Additionally, the modulation signal can be processed with an envelope follower that smooths out the signal contour.

- **Contour:** Blends between the direct signal from the modulation source and the signal processed by the envelope follower. This enables you to adjust how much the envelope follower affects the contour of the modulation signal.
- **Release:** Adjusts the attack and release times of the envelope follower. At low settings, the envelope follower quickly adapts to the contour of the modulation signal. At high settings, it responds slowly and smooths out the contour of the modulation signal.
- **BP Filter:** Switches the band-pass filter applied to the modulation signal on or off. The filter's cutoff frequency can be adjusted with the **BP Freq** control.
- **BP Freq:** Adjusts the cutoff frequency of the band-pass filter applied to the modulation signal, reducing its frequency content to a specific band. When combined with the envelope follower, BP Freq can be used to make the envelope follower respond to specific components of the modulation source.

## Phasis

Phasers are used to enrich sounds by adding spectral animation and complex filtering. They are based on a series of all-pass filters, with built-in modulation of the all-pass filter's frequencies. The all-pass filters produce peaks and notches in the frequency spectrum that can be altered over time. This way a phaser transforms and animates the harmonic structure of the sound. The results range from classic Krautrock guitars to psychedelic FX sounds.

As one of the most commonly used guitar and studio effects, various implementations of the phaser have found their way into studio rack processors and guitar pedals. Phasis is a new take on the concept with additional features that have been carefully chosen to allow for more sophisticated and extreme sounds than possible with common phasers, while staying true to the ease of use and clarity associated with these devices.



Phasis features a scalable amount of all-pass filters, producing up to twelve pairs of peaks and notches in the frequency spectrum. The input signal's stereo image is preserved, however additional processing can be applied to widen the sound (**Stereo** parameter). The internal modulation system can not only alter the relative center frequency of all peaks and notches at the same time (**Center** parameter), but also their spacing to each other (**Spread** parameter), allowing for vowel filtering effects. Further expanding on the original concept of a phaser, **ULTRA** mode extends the frequency ranges of the all-pass filters as well as the modulation to audio rates, further expanding on the filtering capabilities of Phasis create sounds reminiscent of FM synthesis.

Phasis contains the following controls:



- **Rate:** Adjusts the frequency of the modulation applied to **Center** and **Spread**. The modulation effect becomes more pronounced as the Amount is increased. To synchronize the time to your host or master editor tempo, click the Rate unit display (Hz) and chose a note length value from the drop down menu.
- **ULTRA mode:** Extends the parameter ranges for **Rate** and **Center**, allowing for more extreme modulation frequencies across a wider frequency range. By increasing **Rate** to audio frequencies, you can add new harmonic content to the input signal, similar to the sounds possible with FM synthesis.
- **Amount:** Adjusts the amount of modulation applied to **Center** and **Spread**, adding movement to the phasing effect. The modulation can be distributed between the two parameters with the **Mod Mix** slider.
- **Center:** Shifts the peaks and notches in the frequency spectrum by changing the frequencies of the all-pass filters that create the phasing effect (relative to the Center frequency).
- **Stereo:** Creates a wide and lively stereo image by adding a phase offset to the modulation applied to **Center** and **Spread** between the left and right stereo channels. In center position, the phasing effect does not alter the stereo image. When turning the knob to the left, the phasing effect appears to move from right to left. When turning the knob to the right, the phasing effect appears to move from the left to right. **Stereo** does not have an effect if **Amount** is set to 0.
- **Spread:** Adjusts the density of the peaks and notches in the frequency spectrum. Turning the knob left moves the peaks and notches closer to each other. Turning the knob right moves the peaks and notches further apart from each other.
- **Feedback:** Adjusts the amount of feedback, or resonance, applied to the all-pass filters that create the phasing effect. Turning the knob right will increase the **Feedback**, making the peaks and notches in the frequency spectrum more pronounced.
- **Mod Mix:** Distributes the modulation between **Center** and **Spread**. Moving the slider to the left increases the amount of modulation applied to **Center**, moving the slider to the right increases the amount of modulation applied to **Spread**. In the middle position, the amounts of modulation applied to both **Center** and **Spread** are the same.
- **Notches:** Sets the number of peaks and notches in the frequency spectrum.
- **Invert Phase:** Inverts the polarity of the modulation applied to **Spread**, hence reversing its effect in relation to the modulation applied to **Center**.
- **Invert Mod Mix:** Swaps the position of the peaks and notches in the frequency spectrum by inverting the effect signal.

- **Mix:** Blends between the input signal and the effect signal. When the knob is turned fully left, only the dry input signal is heard.
- **Output:** Adjusts the module's output level.

## Ring Modulator

Ring Modulator is an effect based on ring modulation, a special type of amplitude modulation. It produces sidebands in the frequency spectrum that break up the harmonic structure of the sound and give it a metallic sounding character. When using a low-frequency modulation signal, you can achieve tremolo effects. Additionally, the **FM** control enables you to apply phase modulation to the input signal (**FM**).

Ring Modulator contains the following controls:



- **Fast Mode:** Switches between two frequency ranges for the internal modulation oscillator. When activated, the effect produces sidebands in the frequency spectrum. When deactivated, it produces tremolo effects.
- **LFO: Sine/Square:** Switches the LFO's waveform between sine and square, producing either soft or sudden changes of the internal modulation oscillator's frequency.
- **Ring:** Adjusts the amount of ring modulation applied to the input signal using the internal modulation oscillator.
- **Rate:** Adjusts the frequency of the LFO that can be used to apply modulation to the frequency of the internal modulation oscillator. To synchronize the rate to your host or Master Editor tempo, click the Rate parameter's unit display and choose a note length value from the drop-down list.
- **FM:** Adjusts the amount of phase modulation applied to the input signal using the internal modulation oscillator.
- **Amount:** Adjusts the amount of modulation applied to the frequency of the internal modulation oscillator using the LFO.
- **Freq:** Adjusts the frequency of the internal modulation oscillator, effectively moving the sidebands in the frequency spectrum. The frequency range depends on the setting of the **Fast Mode** switch.
- **Edge:** Changes the waveform of the internal modulation oscillator. Turning the control to the right adds harmonics, resulting in a more aggressive sound of the ring modulation.
- **Output:** Adjusts the module's output level.

## Rotator

The Rotator effect realistically simulates the sound of rotating speaker cabinets, which are commonly associated with drawbar organs that became popular in rock music of the 60s and 70s. Although the effect is almost intrinsically tied to "the" prototypical drawbar organ sound, it works equally well on guitars, synth pads, and a wide range of other sounds.

Rotator contains the following controls:

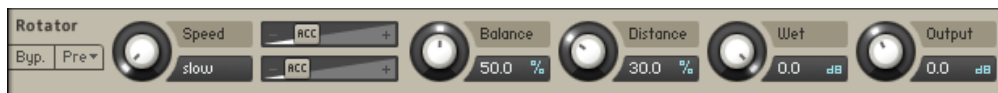

- **Speed:** Although this parameter appears as a knob in order to facilitate automating, it really only has 2 positions – Slow and Fast. A change of this setting realistically simulates the acceleration or braking of the rotor.
- **Acceleration and Brake Speed** (horizontal faders next to the **Speed** control): These adjust how quickly the rotors of the treble (upper fader) and bass (lower fader) parts of the cabinet will react to speed changes. At the rightmost position, the respective speaker will change its speed instantly, while it will take a long time to reach its designated speed with the fader at the leftmost position.
- **Balance:** Controls the relative levels of the cabinet’s treble and bass parts.
- **Distance:** Controls the simulated distance between the cabinet and the pickup microphones. A closer distance results in a wider stereo panorama.

## Vibrato/Chorus

Vibrato/Chorus models the sound of the vibrato and chorus effects found on a classic electric organ. The effects were originally produced by an innovative circuit that combined electronic and mechanical components, producing an incredibly rich sound.

Vibrato/Chorus contains the following controls:



- **Depth:** Sets the intensity of the effect by selecting one of six modes. The intensity increases with every mode from left to right. Modes IV, V, and VI require more processing power.
- **Color:** Selects one of three different modes that determine the basic sound character of the effect. Each mode has a distinct frequency response and different flavor of modulation.
- **Rate:** Adjusts the frequency of the modulation. When Sync is activated, **Rate** is set in note lengths relative to the tempo of the Metronome.
- **Blend:** Blends between the vibrato and the chorus effect.
- **Width:** Adjusts the width of the stereo widening effect.
- **Mix:** Blends between the input signal and the effect signal.
- **Output:** Adjusts the module’s output level in dB.

## Legacy Chorus

The Chorus adds depth and richness to the audio signal by layering the original signal with a detuned copy of itself. Separate LFOs with an adjustable phase relationship detune each stereo channel independently for creating wide panorama effects.

Chorus contains the following controls:



- **Depth:** Adjusts the range of modulated detuning. Higher values give a more pronounced chorusing effect.
- **Speed:** Adjusts the LFO speed. To synchronize the speed to your host or Master Editor tempo, click the Speed parameter's unit display and choose a note length value from the drop-down list.
- **Phase** (0 to 90 degrees): Imparts an LFO phase difference between the left and the right stereo channel. This can considerably increase the width of the output signal's stereo base.
- **Return** (visible when used as a send effect): Adjusts the module's return level.
- **Dry** and **Wet** sliders (visible when used as an Instrument insert effect): Adjusts the respective levels of the original and processed signals. Note that the typical chorus effect is created by the combination of both signals, so setting these to the same levels results in the most pronounced effect.

## Legacy Flanger

This module splits the audio signal up and delays one version in relation to the original signal. By modulating the delay time, as well as feeding an adjustable amount of the output signal back into the input, the Flanger creates a characteristic "whooshing" sound. Just like the Phaser module, the Flanger uses a separate LFO for each stereo channel, with the phase relationship between both LFOs being adjustable.

Flanger contains the following controls:

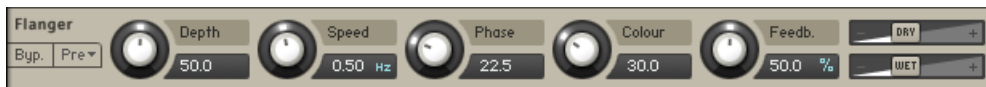

- **Depth:** The amount of LFO modulation. Higher values cause the flanging effect to sweep over a wider range.
- **Speed:** Adjusts the LFO speed. To synchronize the speed to your host or Master Editor tempo, click the Speed parameter's unit display and choose a note length value from the drop-down list.
- **Phase** (0 to 90 degrees): Imparts an LFO phase difference between the left and the right stereo channel. This can considerably increase the width of the output signal's stereo base.
- **Colour:** Adjusts the delay line's range of operation and, consequently, the color of the flanging effect. Small values result in short modulated delay times, making the Flanger sound more like a phaser.
- **Feedback:** Feeds a certain amount of the delayed signal back into the module's input, thereby creating a more pronounced effect.
- **Return** (visible when used as a send effect): Adjusts the module's return level.
- **Dry** and **Wet** sliders (visible when used as an Instrument insert effect): Adjusts the respective levels of the original and processed signals. Note that the typical flanging effect is created by the combination of both signals, so setting these to the same levels results in the most pronounced effect.

## Legacy Phaser

This effect continually changes the phase relationships in your signal with an all-pass filter. This results in a comb filtering effect, which attenuates some frequencies while boosting others. The sound is similar to that of a flanger but in a more subtle manner.

Phaser contains the following controls:



- **Depth:** The amount of LFO modulation. Higher values cause the Phaser effect to sweep over a wider frequency range.
- **Speed:** The LFO modulation speed. To synchronize the speed to your host or Master Editor tempo, click the Speed control's unit display and choose a note length value from the drop-down list.
- **Phase** (0 to 90 degrees): Imparts an LFO phase difference between the left and the right stereo channel. This can considerably increase the width of the output signal's stereo base.
- **Feedb.:** This control adjusts the emphasis of the peaks and notches that the comb filter effect imparts on the signal.
- **Return** (visible when used as Send Effect): Adjusts the return level of the module's output signal.
- **Dry** and **Wet** sliders (visible when used as an Instrument Insert Effect): Adjusts the respective levels of the original and processed signals. Note that the typical phasing effect is created by the combination of both signals, so setting these to the same levels results in the most pronounced effect.

## Mangling

Mangling effects include the Beat Masher, Beat Slicer, Gater, Reverse Grain, and Transpose Stretch.

### Beat Masher

Beat Masher captures a loop from the incoming audio and manipulates it by applying rhythmic stutter, gating, repeater, and reverse effects in real time.

This module contains the following parameters and controls:



- **Mash:** Starts the effect by recording the input signal into the internal buffer. When deactivated, the input signal is unaltered.
- **Length:** Adjusts the length of the audio from the internal buffer, measured in note values.
- **Gate:** Grabs and plays slices of audio from the internal buffer. When turned fully to the left, the effect is bypassed. When turned right towards center position, increasingly longer slices are played. When set to center position, the full buffer is played. When turned right from the center position, increasingly longer slices of audio are cut, creating a gating effect.
- **Rotate:** Shifts the audio from the buffer relative to its original position in steps of 1/8 notes. When **Length** is turned fully to the left, **Rotate** continuously rotates the sample.
- **Mix:** Blends between the input signal and the effect signal.
- **Output:** Sets the output level of the module in dB.
- **Reverse:** Reverses the playback direction of the audio from the internal buffer.
- **Wrap:** Restarts the effect from the start of each bar independently from the **Length** setting.

## Beat Slicer

Beat Slicer captures a loop from the incoming audio and manipulates it by rearranging slices into a variety of rhythmic patterns in real time.

This module contains the following parameters and controls:

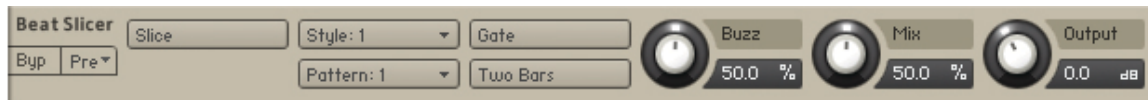

- **Slice:** Starts the effect by recording the input signal into the internal buffer. When deactivated, the input signal remains unaltered.
- **Style:** Selects one of five groups of patterns.
- **Gate:** Gates the audio based on a rhythm derived from another pattern, creating infinite variations through combination of the playback and gating patterns. When activated, the **Buzz** control is inactive.
- **Pattern:** Selects a pattern from the group set using **Style**. The first pattern in each group plays back the unaltered audio from the buffer.
- **Two Bars:** Extends the audio used from the buffer to two bars. Otherwise only the first bar of audio is used.
- **Buzz:** Creates a rolling beat effect by repeating beats from the current pattern. Turning the control to the right increases the rate of repetition.
- **Mix:** Blends between the input signal and the effect signal.
- **Output:** Sets the output level of the module in dB.

## Gater

Gater rhythmically mutes the incoming audio to create the classic gating effect. With the internal noise source, it can be used as a rhythmic sound generator.

This module contains the following parameters and controls:



- **Gate:** Switches the effect on or off.
- **Rate:** Adjusts the rate of the gating effect.
- **Tempo Sync:** Synchronizes **Rate** to the metronome. When **Tempo Sync** is active, **Rate** can be set in note lengths relative to the tempo of the Metronome. The interval can be set to 1/4, 1/8, 1/16, and 1/32 notes.
- **Noise:** Adjusts the amount of hissing noise added to the signal.
- **Mute Input:** Mutes the input signal so that only the effect signal can be heard. When combined with the **Noise** control, the Gater can be used as a rhythmically gated noise source.
- **Shape:** Adjusts the hold and decay times of the gating effect's contour.
  - Turned fully left: 1% hold, 0% decay
  - Center position: 50% hold, 0% decay
  - Turned fully right: 0% hold, 100% decay
- **Stutter:** Sets the gating time to a 3/16 note, producing a stuttering effect.

- **Mix:** Blends between the input signal and the effect signal.
- **Output:** Sets the output level of the module in dB.

## Reverse Grain

Reverse Grain captures a loop from the incoming audio and applies granular processing to it, including control over playback direction, pitch, and grain size.

This module contains the following parameters and controls:



- **Rev:** Starts the effect by recording the input signal into the internal buffer and playing it back in reverse.
- **Fwd:** Inverts the playback direction to forward.
- **Invert Grains:** Plays the grains in reversed order.
- **Pitch:** Adjusts the pitch of the audio from the internal buffer. When turned fully to the right, the pitch is unaltered. Turning **Pitch** to the left pitches the audio down.
- **Grain:** Adjusts the size of the grains used to process audio from the internal buffer. Interesting effects can be achieved when combined with the **Speed** control.
- **Speed:** Adjusts the playback speed of the grains used to process audio from the internal buffer. When turned fully to the right, the playback speed is unaltered. Turning **Speed** to the left reduces the playback speed.
- **Mix:** Blends between the input signal and the effect signal.
- **Output:** Sets the output level of the module in dB.

## Transpose Stretch

Transpose Stretch is a classic pitch shifter with additional grain size and time stretch control.

The module includes the following controls:

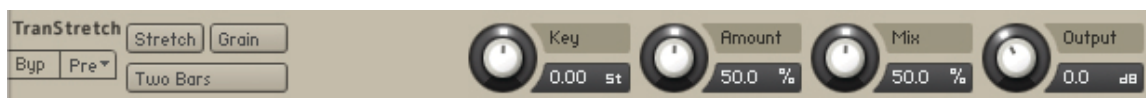

- **Stretch:** Starts the effect by recording the input signal into the internal buffer.
- **Grain:** Activates grain size adjustment. When turned off, grain size is automatically adjusted for best pitch shifting results. When turned on, a **Size** control becomes available. When **Size** is turned fully counter-clockwise, large grains of 333 ms are processed. When turned fully clockwise, short grains of 5 ms are processed.
- **Two Bars:** Extends the audio used from the buffer to two bars. Otherwise only the first bar of audio is used.
- **Key:** Adjusts the pitch of the grains in semitones. When turned fully counter-clockwise, grains are pitched down by 60 semitones, or 5 octaves. At the center position, grains are played back in their original pitch. When turned fully clockwise, grains are pitched up by 12 semitones, or 1 octave.
- **Amount:** Adjusts the amount of time-stretching applied. Gradually turning the control clockwise slows down the speed by which the grains are played back, until finally it freezes using only a single grain.



- **Mix:** Blends between the input signal and the effect signal.
- **Output:** Sets the output level of the module in dB.

## Delays

Delay effects include the Replika Delay and Legacy Delay.

### PsycheDelay

Psyche Delay is a stereo delay effect that produces a range of atmospheric ambient echoes and reverse effects reminiscent of the so-called backwards tape sound of the 1960s.

PsycheDelay contains the following controls:



- **Reverse:** Reverses the playback of subsequent delay repeats.
- **Stereo Reverse:** Reverses the playback of subsequent delay repeats on one of the stereo channels.
- **Stereo Detune:** Adjusts the pitch of the echo repeats on the left stereo channel in the range of -50 to +50 cents. Combined with feedback and cross-feedback you can use this to create progressively detuned echo cascades.
- **Time:** The delay time in milliseconds. To synchronize the time to your host or Master Editor tempo, click the Speed parameter's unit display and choose a note length value from the drop-down list.
- **LR Offset:** Adjusts the amount of time deviation between the two stereo channels, resulting in wide stereo echos.
- **Feedback:** Adjusts the amount of feedback. Turning **Feedback** to the right increases the amount of delay repetitions.
- **Cross FB:** Adjusts the amount of feedback from the left to the right stereo channel and vice versa, creating a more complex stereo echo pattern.
- **Pitch:** Adjusts the pitch of the echo repeats in the range of -12 to +12 semitones. Combined with feedback you can use this to create progressively harmonized echo cascades.
- **Detune:** Fine-tunes the pitch of the echo repeats in the range of -50 to +50 cents.
- **Dry** and **Wet** sliders (visible when used as an Instrument insert effect): Adjusts the respective levels of the original and processed signals. In common scenarios, the delayed signal is mixed in at a lower level than the direct signal.

### Replika Delay

This delay module is based on Native Instruments' dedicated Replika XT delay plug-in. It features five different modes - Modern, Analog, Tape, Vintage and Diffusion - that add distinct colour to your sound.

All modes offer controls for time, feedback level, a low cut filter, a high cut filter, and ping pong effect. Each mode also provides a unique range of parameter controls that allows you to tailor the effect to your specific needs.



Replika Delay contains the following controls:



- **Mode:** Selects one of five delay modes (Modern, Analogue, Tape, Vintage, Diffusion). Each mode offers unique controls, refer to the sections below for details.
- **Time:** Adjusts the delay time in milliseconds. To synchronize the time to your host or Master Editor tempo, click the Time control's unit display (ms) and choose a note length value from the drop-down menu.
- **Feedback:** Adjusts the level of the signal that is fed back to the delay's input. Increasing Feedback adds delay repeats. Levels above 100% create swelling echo repeats up to self-oscillation.
- **Low Cut:** Cuts low-frequency content in the feedback path of the delay with a non-resonant filter. Turned fully counter-clockwise, the filter is off.
- **High Cut:** Cuts high-frequency content in the feedback path of the delay with a non-resonant filter. Turned fully clockwise, the filter is off.
- **Ping Pong:** Switches the Ping Pong effect on and off. When on, the delay repeats are panned hard left and right in an alternating pattern.
- **Stereo:** When activated, the modulation between the left and the right channel is offset in time, resulting in a wide stereo effect. When deactivated, the modulation affects both channels in the same way.
- **Depth:** Adjusts the amount of modulation applied to the delay time.
- **Rate:** Adjusts the speed of the delay time modulation.
- **Pattern:** Shows the controls for modifying the rhythmic feel of the delay. The available controls are:
  - **Shuffle:** Add a swing groove to the delay repeats by delaying the odd-numbered repeats more than the even-numbered repeats.
  - **Feel:** Adjusts the rhythmic feel of the delay. Turning this control clockwise produces a laid-back feel by delaying the repeats slightly. Turning it counter-clockwise produces a slightly rushed feel by repeating slightly before the beat.
  - **Accent:** Adds a dynamic groove effect to the sound by emphasizing certain delay repeats. Turning this control clockwise emphasizes odd-numbered repeats. Turning it counter-clockwise emphasizes even-numbered repeats.
- **Panning:** Shows the controls for modifying the stereo image of the delay. The available controls are:
  - **Pan:** Adjusts the panning of the delay signal from left to right.
  - **Width:** Adjusts the total width of the stereo image.
  - **LR Offset:** Enhances the stereo image of the delay by adding a timing offset between the left and right channels.

- **Ducking:** Shows the controls of the ducking effect built into the delay, which reduces the gain of the delay signal when the input signal rises past a certain threshold. Next to a gain reduction meter, displaying the gain reduction of the input signal in dB, the available controls are:
  - **Sensitivity:** Adjusts the threshold at which the ducking effect set in.
  - **Release:** Adjusts the release time of the ducking effect.
  - **Amount:** Adjusts the strength of the ducking effect or the amount of gain reduction applied to the delay signal when the ducking effect is triggered.

### Modern mode

The Modern mode is a clean and defined delay that can be further shaped with its adjustable, tube-like **Saturation**. The built-in modulation changes the delay time periodically. This shifts the timing and pitch of the delay signal, adding depth and movement to the sound. Unlike the built-in modulation, manual adjustments of the delay time do not alter the pitch of the delay signal.

- **Saturation:** Adds tube-like saturation at the delay input. Turning it clockwise pushes the sound from subtle warmth to overdrive. Turned fully counter-clockwise, the saturation is bypassed.

### Analogue mode

The Analogue mode emulates the dark and hazy sound of BBD (Bucket Brigade Device) delays, which include old analogue studio effects as well as many contemporary guitar pedals. **BBD Type** offers four different models, giving you the full range of warm sounds associated with these delay effects.

- **BBD type:** Selects one of four BBD delay models (from left to right, Grunge, Dark, Warm, Clean). The character ranges from subtle filtering and distortion to a highly degraded sound.

### Tape mode

The Tape mode emulates the textured and lively sound of classic tape delays. It gives you full control over their unique properties, including the amount of **Saturation**, the **Age** of the tape, and the intensity of **Wow & Flutter**.

- **Noise:** When activated, tape hiss is added to the delay signal. When deactivated, no tape hiss is added. The amount of tape hiss depends on the setting of the Tape Age control.
- **Tape Age:** Enhances the characteristics of an aging tape, including limited high-frequency response. When the Noise button is activated, Tape Age also adjusts the amount of tape hiss added to the signal.
- **Flutter:** Increases the effects introduced by mechanical imperfections of the tape delay's motor and tape transport, resulting in pitch variations over time.

### Vintage mode

The Vintage Digital mode emulates the warm and crunchy sound of early digital delay effects. Four different **Quality** settings available, ranging from a bright sound with subtle textures to strong digital artifacts.

- **Quality:** Selects one of four quality settings for the delay: Crunch (0-24%), Low (25-49%), Medium (50-74%), High (75-100%).

## Diffusion mode

The Diffusion mode links a clean delay to a unique reverb effect. It can be used to create a wide range of different ambiances, from tight and resonant to unnaturally vast spaces. The **Amount** of diffusion applied to the delay signal is freely adjustable, and the **Movement** control adds modulation to the reverb effect.

- **Amount:** Adjusts the amount of diffusion applied to the delay signal, resulting in a reverb effect. High settings can make the delay appear out of sync.
- **Size:** Adjusts the swell, reflection pattern and decay of the reverb effect, giving the impression of different sized spaces.
- **Dense:** Switches between two density settings for the reflection pattern of the effect.
- **Modulation:** Sets the depth and speed of modulation applied to the diffusion, shifting the timing and pitch of the reflections for a wide reverb effect.

## Twin Delay

Twin Delay combines two parallel delay channels for advanced stereo effects. The two delays are dedicated to the left and right stereo channel, respectively. You can use them to create rhythmic echoes that bounce through the stereo image.

Twin Delay includes the following controls:



- **Predly L/R:** Adjusts the duration of the initial delay added to the channel. This predelay is independent of the **Time** control and does not affect the delay repeats. To achieve classic ping-pong echoes, set the same **Time** for both channels and increase **Predly** on one of them. To synchronize the time to your host or master editor tempo, click the predelay unit display (ms) and chose a note length value from the drop down menu.
- **Time L/R:** Adjusts the delay time in milliseconds. To synchronize the time to your host or master editor tempo, click the Time unit display (ms) and chose a note length value from the drop down menu.
- **Feed L/R:** Adjusts the amount of feedback. Turning **Feed** to the right increases the amount of delay repetitions.
- **Level L/R:** Adjusts the output level of the delay channel.
- **Cross FB:** Adjusts the amount of cross-feedback, which feeds the left channel output back into the right channel input and vice versa.
- **Width:** Adjusts the stereo image of the delay signal. At center position, the signal is mono. Turning the control to the right increases the width of the stereo image. Turning the control to the left increases the width of the stereo image and flips the left and right stereo channel.
- **DRY/WET:** These sliders adjust the amount of unprocessed (**DRY**) and processed (**WET**) signal that is send to the output.

## Legacy Delay

This module offers a delay line that can optionally be synced to the tempo and provides an adjustable feedback level, a low-pass filter, and a pan control for ping-pong echo effects. If you don't use the tempo syncing feature, the available delay range is 5 to 2900 ms. Delay times lower than 20 ms are not discernible as delays, but can produce interesting comb filtering effects.

Legacy Delay contains the following controls:



- **Time:** The delay time in milliseconds. To synchronize the time to your host or Master Editor tempo, click the Speed parameter's unit display and choose a note length value from the drop-down list.
- **Damping:** Attenuates high frequencies in the delayed signal. Turning this control clockwise will increase the damping effect. If you have set a feedback level, the signal will gradually lose more high frequency content with each repetition.
- **Pan:** Setting a value higher than 0 creates a panning effect, which alternates echos between the left and the right side of the stereo panorama — this is affectionally called a ping-pong delay. Higher values will result in wider panning; at 100, signals alternate between the far left and far right channel.
- **Feedb.** (feedback): Controls the amount of the output signal that's being fed back into the input of the delay line, thereby creating a series of echos that gradually fade into silence.
- **Return** (visible when used as a send effect): Adjusts the module's return level.
- **Dry** and **Wet** sliders (visible when used as an Instrument insert effect): Adjusts the respective levels of the original and processed signals. In common scenarios, the delayed signal is mixed in at a lower level than the direct signal.

## Reverbs

Reverb effects include the Convolution, Plate Reverb, Reverb and Legacy Reverb.

### Convolution

Convolution is a sophisticated mathematical process that, technically speaking, allows you to replicate the acoustical behavior of a linear system — such as a room, a speaker or a hardware reverb unit — for use with your own signals. To accomplish this, a short audio recording of a wide-band signal played through the system is fed into the convolution processor. This recording is usually a normal audio file, called an impulse response.

Convolution is best known among users as a method for achieving highly realistic reverbs; it works just as well for simulating the characteristic resonances of speaker cabinets and other loudspeakers, though.

Kontakt's Convolution processor is somewhat unique in that it fully supports a multi-channel signal flow, allowing you to use surround impulse responses. It can be used within the Instrument Insert Effects and the Instrument Send Effects chains, or as an Output effect. Kontakt includes an extensive library of impulse responses, which range from recordings of real rooms and speaker cabinets to synthetic impulse responses that are well-suited for special effects, but you can just as easily use third-party impulses in WAV format.

Convolution contains the following controls:



- **Impulse Window:** This window provides a display of the currently loaded impulse response and, if active, the Volume Envelope. You can drag impulse responses from the library into this window to load them – this will keep your other settings intact. The row at the top displays the filename of the loaded impulse response, as well as its bit depth, sample rate, and number of channels. Just like in the Mapping Editor and Wave Editor, hovering your mouse pointer over the filename will show the full path to the file.
- **Pre Dly.:** Just like the Reverb module's parameter of the same name, this control introduces a short amount of delay between the direct signal and the convolution output. This is useful when used with reverb responses to simulate the reverberation of big rooms, where a short delay occurs between the direct sound and the first reflections from distant walls.
- **Return** (visible when used as a send effect): Adjusts the module's return level.
- **Dry and Wet sliders** (visible when used as an Instrument insert effect): Adjusts the respective levels of the original and processed signals. In common scenarios, the reverb signal is mixed in at a lower level than the direct signal.
- **Latency:** Adjusts the module's latency setting in five steps (1.5, 2.9, 5.8, 11.6, and 23.2 ms). If you hear crackles or other artifacts, you can try to increase this value, which will result in Kontakt's overall latency being increased (and thus all signals being delayed). If you don't want this, you can disable the latency compensation by activating the last entry in this menu. This way, the overall latency won't be increased, but the wet signal of the Convolution processor will be delayed in relation to the dry signal (which actually can work just fine with reverbs).
- **S. Rate:** Allows you to divide the sample rate in nine steps (1/1, 1/1.5, 1/2, 1/2.5, 1/3, 1/4, 1/6, 1/8, and Auto). If the **Preserve Length** button is not activated, changing the sample merely changes the playback speed of the impulse response, resulting in longer reverb trails and changed frequency characteristics. Activating Preserve Length will keep the reverb trail intact, but lower the sampling rate at which the convolution process takes place, thereby reducing the CPU usage along with the quality.
- **Reverse Button:** Reverses the impulse response for special effects.
- **Auto Gain:** If this button is active, the processor will keep the overall level constant when parameters are adjusted that would otherwise affect the level. If you turn this off, be sure to monitor at low levels as you make adjustments, as volume changes can be drastic – take care of your ears!
- **VolumeEnvelope:** This feature allows you to change the volume characteristic of the impulse response to your needs. When activated, a graphically editable 8-segment envelope will be drawn on top of the waveform display in the impulse response window.
- **Early / Late:** These mode buttons switch the 3 knobs below between affecting the early reflections and the trail part of the impulse response.
- **IR Size:** Artificially compresses or stretches the impulse response in time.
- **HighPass:** Adjusts the cutoff frequency below which the signal's frequency content will be attenuated.

- **LowPass:** Adjusts the cutoff frequency above which the signal's frequency content will be attenuated.

## Plate Reverb

This new effect module emulates a plate reverb. Plate reverb was developed as an early method of generating an artificial reverb effect. A vibrating sheet of metal is employed to simulate reflection patterns in acoustical spaces. Since the sheet of metal vibrates across a two-dimensional plane, the echo density is higher and more evenly distributed than in a three-dimensional space. It is a good choice if you want to brighten a sound source. Plate reverb has a smooth reverb tail, allowing you to lengthen a sound without pushing it back in the mix. For this reason plate reverbs are most commonly used on vocals and snare drums. The Damping control affects the overall tone, so applying it to a bright source warms the sound.

Plate Reverb contains the following controls:



- **Pre Delay:** Introduces a short amount of delay before the reverb takes effect.
- **Decay:** Adjusts the duration of the reverb effect.
- **Low Shelf:** Attenuates or amplifies the low-frequency content of the reverb signal.
- **High Damp:** Adjusts the damping of high-frequency content of the reverb signal.
- **Stereo:** Controls the stereo image of the reverb effect. Higher values result in a wider stereo image.

## Raum

Raum offers three different reverb algorithms that cover an extremely wide range of reverb sounds. Each of them is based on a different paradigm: **Grounded** focuses on rooms, **Airy** on halls, and **Cosmic** on abstract spaces. However, the individual parameters like **Size** and **Decay** are designed in such way that each of the algorithms can be used to create anything from tight ambiences to otherworldly soundscapes, while maintaining the basic character of its paradigm.

Raum includes the following controls:



- **Mode:** Selects one of three different reverb algorithms, from rooms (**Grounded**), to halls (**Airy**), to abstract spaces (**Cosmic**).
- **Predelay:** Adjusts the duration of the predelay, which is the time it takes for the reverb effect to set in. By increasing the predelay, you can add separation between the input signal and the reverb signal. To synchronize the time to your host or Master Editor tempo, click the Predelay parameter's unit display and choose a note length value from the drop-down list.

- **Feedback:** Adjusts the level of the feedback signal from the output of the predelay to its input, effectively increasing the number of delay repetitions. Turning **Feedback** to the right creates echo effects that can be further processed using the selected reverb algorithm. When **Feedback** is set to 100%, you can achieve infinite delay repeats and therefore use the predelay as a looper. A built-in limiter controls the level when high feedback settings are used with loud input signals.
- **Low Shelf:** Attenuates low-frequency content of the reverb effect and the predelay's feedback signal by applying a low-shelf filter in the range of 0 dB to -24 dB. Turning the control to the left decreases the attenuation. Turning the control to the right increases the attenuation. Turning the control fully to the left switches the filter off.
- **High Cut:** Attenuates high-frequency content of the reverb effect and the predelay's feedback signal by applying a high-cut filter in the range of 90 kHz to 1 kHz. Turning the control to the left increases the attenuation. Turning the control to the right decreases the attenuation. Turning the control fully to the right switches the filter off.
- **Freeze:** Holds the reverb's sound content for as long as the function is activated. The Freeze function is available for the Grounded and Airy algorithms. Switching is optimized for smooth transitions without clicks, and you can still use the **Size** control to manipulate the sound. This makes the Freeze function an excellent tool for live performance and automation.
- **Reverb:** Adjusts the amount of reverb added to the effect signal.
- **Diffusion:** Adjusts the texture of the reverb reflections. Turning the control to the right softens the early reflections and produces a smooth onset of the reverb.
- **Size:** Adjusts the swell and reflection pattern of the reverb effect, creating the impression of differently sized spaces. Turning the control to the right changes the size from small to large.
- **Sparse:** Switches between two basic density modes for the reflection pattern of the reverb effect, Sparse and Dense. When enabled, Sparse produces dispersed and clearly discernible reflections. When disabled, Dense produces a more uniform reverb tail.
- **Decay:** Adjusts the length of the reverb, or reverb time. Turning the control to the right changes the reverb time from short to long.
- **Damping:** Adjusts the tonal quality from bright to dark. Turning the control to the right attenuates the reverb's high-frequency content.
- **Mod:** Adjusts the amount of movement added to the reverb sound by changing internal parameters of the reverb over time. Turning the control to the right changes the movement of the reverb from lush to strongly detuned sounds.
- **DRY/WET:** These sliders adjust the amount of unprocessed (**DRY**) and processed (**WET**) signal that is sent to the output.

## Reverb

This algorithmic reverb offers Room and Hall modes. Room mode generates a natural reverb with strong initial reflections and a quick decay. You can use this to simulate the natural sound of a small acoustic space. With a faster reverberation time, it is particularly suited to drums and guitars.

Hall mode emulates the immensity of a large hall space, with a warm and rich sounding reverb. This can be used to replicate a vast, natural space. The large reverberation and long decay time make it a great tool to experiment with on a variety of sounds. In either mode, you can modulate the Room Size and Pre Delay parameters to create dynamic special effects.

Reverb contains the following controls:





- **Mode:** Selects one of two reverb modes (Room and Hall). Room is suited to drum and percussive sounds. Hall has a spacious and natural character and is particularly suited to tonal sounds.
- **Pre Delay:** Introduces a short amount of delay before the reverb takes effect.
- **Size:** Adjusts the size of the room simulated by the reverb effect. Higher values replicate larger rooms.
- **Time:** Adjusts the duration of the reverb effect.
- **Damping:** Adjusts the amount of absorption in the room simulated by the reverb effect. Higher values result in more absorption.
- **Diffusion:** Adjusts the density of the reflections in the room simulated by the reverb effect.
- **Modulation:** Adjusts the amount of modulation applied to the reverb effect. Turned fully counter-clockwise, no modulation is applied.
- **Low Shelf:** Attenuates or amplifies the low-frequency content of the reverb signal.
- **High Cut:** Cuts the high-frequency content of the reverb signal.
- **Stereo:** Controls the stereo image of the reverb effect. Higher values result in a wider stereo image.

## Legacy Reverb

This module simulates the natural reverberation that occurs when a sound source is placed in an acoustic environment, thus adding a feeling of spaciousness to the sound.

Legacy Reverb contains the following controls:



- **Pre Dly.:** Introduces a short delay between the direct signal and the reverb trail build-up. This corresponds to the natural reverberation behavior of large rooms, where a short time elapses before the first reflection of a sound wave returns from a wall.
- **Size:** Adjusts the size of the simulated room. This affects the duration of the reverb trail.
- **Colour:** This control allows you to adjust the construction material of the simulated room and, consequently, the color of the reverb trail. Low values simulate softer surfaces like wood, while high values simulate the reflection behavior of hard surfaces like concrete.
- **Damping:** Sets the amount of simulated absorption that takes place in rooms due to furnishings, people, or acoustic treatments affecting the reflection behavior.
- **Stereo:** Higher values increase the stereo base width of the output signal. Lower values simulate a closer distance to the sound source.
- **Return** (visible when used as a send effect): Adjusts the module's return level.



- **Dry** and **Wet** sliders (visible when used as an Instrument insert effect): Adjusts the respective levels of the original and processed signals. In common scenarios, the reverb signal is mixed in at a lower level than the direct signal.

## Spatial

### Stereo Modeller

This module allows you to control the width of your signal's stereo base, change the panning, and create a pseudo-stereo signal from mono sources.

Stereo Modeller contains the following controls:

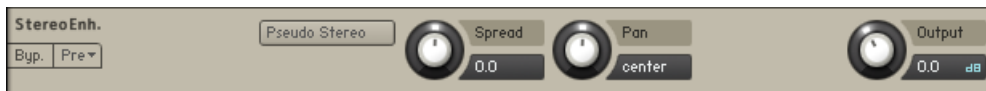

- **Pseudo Stereo:** When activated, the module uses a pseudo-stereo algorithm to create a stereo signal from a mono source. This feature should only be used with mono signals and tends to create mono-incompatible sounds, which can disappear from a mix when it's being played back in mono.
- **Spread:** Reduces or expands the signal's stereo base. Turning the knob far left, will sum the stereo signals to mono. Turning the knob right to produce positive values will result in an artificial widening of stereo sources.
- **Pan:** This control allows you to place your signal within the stereo field. It works exactly like the Pan control of the Amplifier module.
- **Output:** Adjusts the module's output level.

### Stereo Tune

Stereo Tune is a widening effect. It produces a wide and lively stereo image.

Stereo Tune contains the following controls:



- **Spread:** Adjusts the stereo width from mono to full stereo.
- **Drift:** Adjusts stereo detuning of the input signal. The left and right stereo channels are tuned at different frequencies to create a wide stereo image.
- **Split:** Adjusts the crossover frequency of the effect. Frequency content below this frequency remains unaltered.
- **Mix:** Blends between the input signal and the effect signal. When the knob is turned fully left, only the dry input signal is heard.
- **Output:** Adjusts the module's output level.

## Surround Panner

This module provides extensive and powerful surround mixing and automation capabilities to Group signals. It works with a multitude of input and output channel configurations, ranging from mono up to 16-channel surround sound, and allows you to place input signals as sound sources on a spatial plane, move them either manually or via automation, and simulate a range of natural dampening and doppler effects which occur when sound sources are being moved around the listener.

Surround Panner contains the following features and controls:

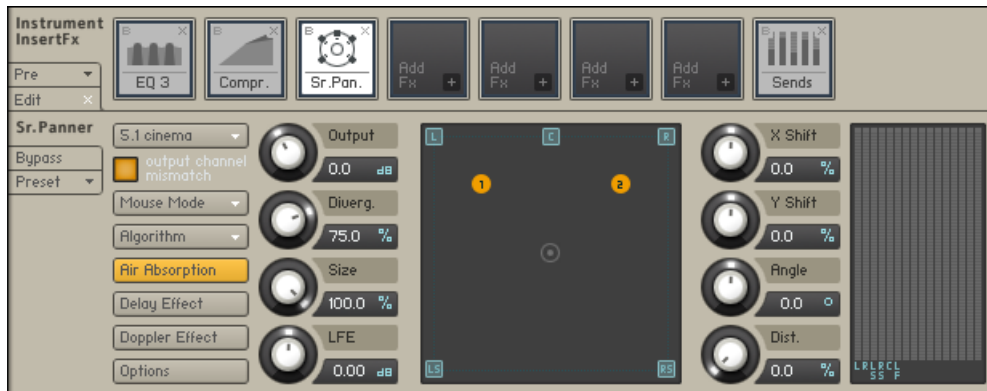

- **Output:** Adjust the module's output level.
- **Divergence:** Adjusts the amount of distance-dependent level changes and, consequently, the directional focus of sound sources on the surround plane. Setting the knob to 0% will result in constant levels regardless of positioning.
- **Size:** Adjusts the size of the surround plane. When set to 100%, the area surrounded by the speakers will fill out the plane window, so it won't be possible to move a sound source beyond the limits of the speakers. Turning the knob counter-clockwise will "zoom out" and allow you to place sources outside the area of the speaker arrangement.
- **LFE:** If the currently selected output configuration includes a low frequency effects (LFE) channel, this control adjusts its output level. Note that the LFE channel signal is derived from a sum of all input signals via a frequency crossover; the frequency at which the split occurs can be set in the options dialog.
- **X Shift:** Imparts a constant offset on the X positions of all sound sources.
- **Y Shift:** Imparts a constant offset on the Y positions of all sound sources.
- **Angle:** Rotates all sound sources around the center point.
- **Distance:** Adds a constant offset to the distances of all sound sources from the center point.
- **Meter:** The output levels of all channels in the currently selected Surround Format are displayed here.

## Menus and Buttons

The following menus are available:

- **Surround Format:** This drop-down menu selects the output format of the module. Options range from simple speaker-subwoofer splits (**1.1**) up to 16-channel surround formats, and also include a wide range of common cinema and music surround formats like 5.1, 7.1 and 10.2. Changing this setting does not affect the positions of your sound sources on the plane. The following table lists all available surround formats along with their channel assignments. Refer to these channel maps if you're unsure which channel will carry which speaker signal at the module's output.

Audiochannel#	1	2	3	4	5	6	7	8	9	10	11	12	13	14	15	16
1.1 Mono + LFE	C	Lf														
2.0 Stereo	L	R														
2.0 Stereo Wide	L	R														
2.1 Stereo + LFE	L	R	Lf													
2.1 Stereo Wide + LFE	L	R	Lf													
3.0 Surround (LRS)	L	R	S													
3.0 Front (LCR)	L	R	C													
3.1 Surround (LRS) + LFE	L	R	S	Lf												
3.1 Front (LCR) + LFE	L	R	C	Lf												
4.0 Surround (LRCS)	L	R	C	S												
4.0 Quadraphonic	L	R	Ls	Rs												
4.1 Surround (LRCS + LFE)	L	R	C	S	Lf											
4.1 Quadraphonic (+ LFE)	L	R	Ls	Rs	Lf											
5.0 Cinema	L	R	Ls	Rs	C											
5.0 Music	L	R	Ls	Rs	C											
5.0 Pentaphonic	L	R	Ls	Rs	C											
5.1 Cinema + LFE	L	R	Ls	Rs	C	Lf										
5.1 Music + LFE	L	R	Ls	Rs	C	Lf										
5.1 Pentaphonic + LFE	L	R	Ls	Rs	C	Lf										
6.0 Cinema EX	L	R	Ls	Rs	C	Cs										
6.0 Music EX	L	R	Ls	Rs	C	Cs										
6.0 Hexaphonic	L	R	Ls	Rs	C	Cs										
6.1 Cinema EX + LFE	L	R	Ls	Rs	C	Cs	Lf									
6.1 Music EX + LFE	L	R	Ls	Rs	C	Cs	Lf									
6.1 Hexaphonic + LFE	L	R	Ls	Rs	C	Cs	Lf									
7.0 Cinema	L	R	Ls	Rs	Lc	Rc	C									
7.0 Music	L	R	Ls	Rs	L2	R2	C									
7.0 Heptaphonic	L	R	Ls	Rs	L2	R2	C									
7.1 Cinema + LFE	L	R	Ls	Rs	Lc	Rc	C	Lf								
7.1 Music + LFE	L	R	Ls	Rs	L2	R2	C	Lf								
7.1 Heptaphonic + LFE	L	R	Ls	Rs	L2	R2	C	Lf								
8.0 Octaphonic Circ	L	R	Ls	Rs	L2	R2	C	Cs								
8.0 Octaphonic Rect	L	R	Ls	Rs	L2	R2	L3	R3								
8.1 Octaphonic Circ + LFE	L	R	Ls	Rs	L2	R2	C	Cs	Lf							
8.1 Octaphonic Rect + LFE	L	R	Ls	Rs	L2	R2	L3	R3	Lf							
10.2 Surround TH + 2 LFE	L	R	Ls	Rs	L2	R2	C	Cs	Lh	Rh	Lf	Lf				
12.0 Cinema Extended	L	R	Ls	Rs	Lc	Rc	C	Cs	L2	R2	L3	R3				
12.1 Cinema Extended + LFE	L	R	Ls	Rs	Lc	Rc	C	Cs	L2	R2	L3	R3	Lf			
13.0 Cinema Plus	L	R	Ls	Rs	Lc	Rc	C	Cs	Lh	Rh	L3	R3	CC			
13.1 Cinema Plus + LFE	L	R	Ls	Rs	Lc	Rc	C	Cs	Lh	Rh	L3	R3	CC	Lf		
16.0 Cinema Surround	L	R	Ls	Rs	Lc	Rc	C	Cs	Lh	Rh	L3	R3	L2	R2	C2	C3
16.0 Theater Surround	L	R	Ls	Rs	Lc	Rc	C	Cs	Lh	Rh	L3	R3	L2	R2	C2	C3

Table of available surround formats, along with their channel assignments.

### Channel Abbreviations

Channel	Abbreviation
Left	L
Right	R
Left 2	L2
Right 2	R2
Left 3	L3
Right 3	R3
Center	C
Left Center	Lc
Right Center	Rc
Center Surround	Cs

Channel	Abbreviation
Center Center	CC
Center 2	C2
Center 3	C3
Surround	S
Left Surround	Ls
Right Surround	Rs
Low Frequency Effects	Lf
Left High	Lh
Right High	Rh

If you need to re-assign channels to different outputs, you can do this on the Channel Routing page of the Amplifier Module. Refer to [Section : Amplifier Module](#) for an in-depth explanation.

- **Mouse Mode:** This drop-down menu allows you to choose from a list of algorithms which affect how your input sources will be positioned on the plane and respond to mouse movements.
  - **Mono Mix:** All sound sources will be set to the same position.
  - **Sync:** When you drag a sound source, all other sound sources will move along in the same direction.
  - **Center Mirror:** Sound source positions will be mirrored at the center point of the plane.
  - **X Mirror:** Sound source positions will be mirrored along the X axis.
  - **Y Mirror:** Sound source positions will be mirrored along the Y axis.
  - **XY Mirror:** Sound source positions will be mirrored along the X and Y axis.
  - **Individual:** Each source can be positioned individually with the mouse.
- **Algorithm:** Determines how the level of a sound source will be affected by its distance from the center. The drop-down menu offers three algorithms:
  - **Constant Power:** This panning algorithm will adjust the relative speaker levels of a sound source in a way that preserves the source's apparent volume, regardless of its panning position. Placing a source icon right above a channel icon will isolate the source signal on the respective channel. Moving it around the plane will distribute its signal among the respective speakers in relation to their distance from the source, keeping the overall apparent volume (or, more precisely, the power) constant. This behavior will be affected by the **Divergence** setting.
  - **Sinusoid:** This algorithm uses a sine function to adjust the volume of a source in relation to its distance from each speaker. Setting the Divergence parameter to lower values will result in a more directional image. If you move a source far away from speakers and use a high Divergence setting, its level can drop to silence.
  - **Logarithmic:** This panning algorithm uses a logarithmic function to change the level of a source in relation to its distance from each speaker.

None of the above algorithms or modes is tied to a specific channel format. We recommend that you experiment with the algorithms and parameters in order to find the most suitable setting for your surround production.

- **Air Absorption:** If a sound source moves away from a listener in the real world, the sound that reaches the listener will gradually lose its high frequencies. When this button is activated, the Surround Panner will simulate this absorption effect. If you'd like to increase the impression of distance further, even after you've dragged a sound source all the way to the plane border, increasing the size of the sound field with the **Size** control will gain you some more space.
- **Delay:** As sound waves take some time to propagate through the air, sounds from sources which are further away from a listener will be delayed in relation to sounds in the vicinity. When this button is activated, the Surround Panner will replicate this effect with a delay line. Enabling this feature can dramatically improve localization, but it also uses a lot of CPU power. If you want to simulate positioning entirely with delays (and keep levels always constant), set the divergence control to 0%.
- **Doppler Effect:** In the real world, this effect – usually associated with ambulances or racing cars going past – is a direct consequence of the delay and intrinsically tied to it; in the microcosm of Kontakt, though, both effects can be separately controlled. When this button is activated, the Surround Panner simulates the pitch change when a sound source moves quickly toward or away from a listener. To hear this effect in action, move the sound source rapidly from one corner into the opposite one. It's more pronounced when the travel distance is longer, so you might have to zoom out with the **Size** control in order to hear it.

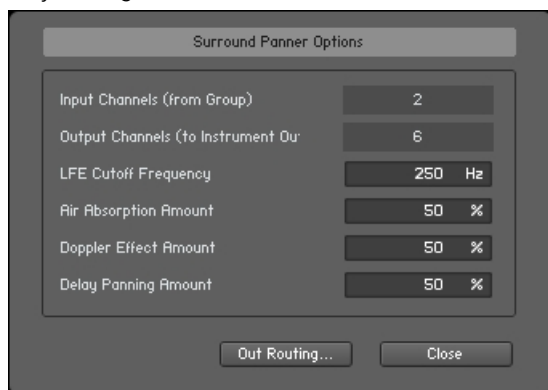

The Surround Panner Options dialog lets you adjust various parameters of the Doppler, Air Absorption, and Delay effects.

- **Options:** This button will open a pop-up dialog which allows you to change the underlying parameters of the Doppler, Air Absorption, and Delay effects; furthermore, you can adjust the crossover frequency for the LFE channel. The dialog will also display the number of input and output channels that are currently in use. The button labeled Out Routing... will take you directly to the Channel Routing section of the Amplifier Module, where you can change channel routings and create mix-up or mix-down configurations to convert between channel layouts.

## Surround Panner Automation

Automating the surround panner is particularly interesting for creating sounds that move around the room. There are several ways to accomplish this. If you need complete control over your motion patterns, you can use your host automation or external MIDI controllers to control the positioning parameters from outside Kontakt. If you want to create automatic motion, using Kontakt's Modulation Router opens up a range of very interesting and creative possibilities.

## Host/MIDI Automation

If you want to modulate the Surround Panner via your host or external MIDI controllers, you can assign external host automation data or MIDI controllers to the X Shift, Y Shift, Angle, and Distance parameters by dragging the respective automation sources from the **Automation** tab of the Side pane onto the knobs you'd like to automate. For more information about external automation, refer to section [Automation Tab](#).

## Internal Modulation

Using internal modulators on the Surround Panner offers a multitude of interesting possibilities, ranging from sounds that move around the room in a circular fashion to unpredictable and organic patterns of random motion. To create a modulation assignment, right-click a knob and choose a modulation source from the drop-down menu, then adjust the assignment parameters and the source's controls (if any). Note that only the knobs to the right of the XY pad can be assigned for internal modulation. The knobs on the left can be automated via MIDI CC.

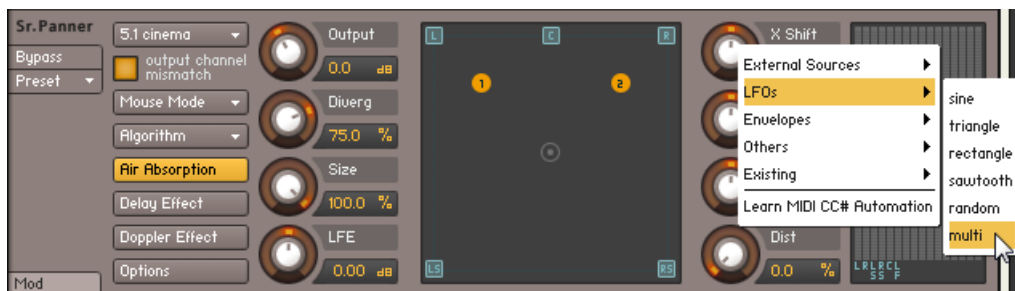

The buttons to the right of the XY pad can be assigned to a selected modulation source.

After you have created an assignment, observe the Surround Panner's plane window when playing a note; you'll notice that for every static source icon, there's a darker icon moving along the plane. The bright icons display the sources' original positions (which can still be changed by dragging the icons around), while the darker icons depict the actual positions after all modulations have been applied.

It's hardly possible to describe the whole range of applications of modulating the Surround Panner's parameters, so we'll look at a few common scenarios instead. Re-creating these should get you a feel for what will be possible with some further experimentation.

- **Circular motion.** In order to rotate your sources around a pivot point, thereby creating a circular motion path, modulate the Angle parameter of the Surround Panner via a Sawtooth LFO. The distance of each source from the pivot point can be changed either by dragging the original positions, or via adjusting the surround panner's Distance parameter. To change the direction of the movement, enable the **Invert** button of the assignment in the Modulation Router. You can also synchronize the motion to the host or Master Editor tempo by switching the unit of the LFO's Freq. parameter to a note value.
- **Random motion.** This is a basic method to make your sources move around in an unpredictable way. Just assign two random modulators to the X Shift and Y Shift parameters. You can adjust how far the sources will stray from their original positions by adjusting the modulation intensities of these assignments.
- **Fly-by paths.** Assigning envelope modulators to various parameters, most notably X Shift and Y Shift, allows you to define accurate and reproducible motion paths. It can get a while to understand how various envelope shapes relate to the resulting motion patterns, but once you've gotten the grip on it, you'll be able to create virtually all kinds of pre-defined motion paths — especially when you're using flexible envelopes.

## Utilities

Utilities includes the Gainer, Inverter, Send Levels, Stereo Modeller and Surround Panner Insert effects. Utilities also includes the Group Insert effect the AET Filter and the Gainer Send effect.

## AET Filter

This module constitutes the core of the powerful Authentic Expression Technology (AET) in Kontakt, which allows you to “morph” continuously between the timbral characteristics of multiple samples. The module is designed to work on the Group level, so it can only be placed in the Group Insert FX chain.

As the process of creating and using a morph extends to other elements of the user interface than this module itself, we’ll start with a high-level explanation of the idea and technology behind AET; if you’re just interested in a reference of the involved dialogs and the module’s controls, you can find those at the end of this section.

## About Authentic Expression Technology

When sampling acoustic instruments, one of the common difficulties to overcome stems from the fact that most of them change their tonal characteristics radically throughout their range of dynamic and expression — a french horn played **mf** can sound very different from one played **p**. This makes it more difficult to capture the whole range of their sonic character in a convincing way with static samples alone. The traditional approach has been to tackle this problem with sheer size: Sample libraries that contain several dozen velocity layers per note have now become a common occurrence, and indeed, this is a good way to increase the sampled instrument’s level of detail. In a lot of cases, though, the shortcomings of turning highly dynamic instrumental sounds into static samples, such as noticeable timbre changes when moving from one velocity layer to the next, still persist.

With the Authentic Expression Technology (AET) in Kontakt, we’d like to introduce a radically different approach. The core of this technology is an FFT filter with a very high resolution, which is able to “imprint” frequency responses of almost any complexity on your signal. These frequency responses are derived from other samples in your patch via spectral analysis. For instance, the currently playing velocity layer could be filtered with the spectral information of the layer just above it to sonically shift it closer to the latter. By dynamically varying the amount of processing with the help of a modulation source (such as the velocity), you can thereby pass through any number of intermediate stages between two samples, thus “morphing” between them in real-time.

The process is not limited to dynamic layers, either: You can morph between different playing techniques of an instrument (such as a trumpet playing with and without mute) or even between different signals. This opens up a whole range of sound design possibilities — fancy a morph between a piano and a celesta!

The functionality of AET is split up into two logically separate parts. In the analysis phase, you tell Kontakt which Samples should be taken into consideration; it will then generate spectral “fingerprints” of these and save them for later use. This selection and setup process takes place in the Mapping Editor. Once the fingerprints have been created, they become available for selection within the AET Filter module, which you can insert into a Group Insert FX slot just like any other effect module. Here’s where the actual filtering takes place: With just a single parameter, you can control which of the stored frequency responses will be imparted to which amount on the currently playing sample.

Before we dive head-first into an actual use case of AET, we should explain two of the logical building blocks you’ll encounter in the setup process:

- A **Morph Layer** is a group of non-overlapping Zones whose samples are directly related in some way; these are often stacks of velocity layers or multi-sampled Zones that cover a certain key range, or in other words, blocks of adjacent Zones in the Mapping Editor.



- A **Morph Map** is a collection of one or more Morph Layers. This is what's ultimately loaded into the AET Filter module, and its contents decide what the **Morph** knob on the module's control panel will do. A Morph Map that contains only one Morph Layer is called a velocity map; in this case, the target frequency response will be derived from the Zone whose keyboard range matches the currently pressed key, and whose velocity range corresponds to the setting of the **Morph** knob. A Morph Map with multiple Morph Layers is the basis of an articulation morph; this is the more complex case, which allows you to set up morphs between two or more sets of Samples which are not necessarily related, such as different playing techniques or even entirely different instruments. Usually, the Morph Layers in such a map originate from different Groups in your Instrument.
- In short: If you want to use the expression filter for dynamic velocity morphing, a Morph Map with only one Morph Layer will do fine (the **Auto add AET velocity morph** function described below will even set this up for you); if you want to do more complex things, you'll have to create a Morph Map that consists of multiple, manually defined Morph Layers.

Now that you know what Authentic Expression Technology is and what it can do for you, let's take a look at how to use it in real-world situations.

## Creating a Velocity Morph

This is the basic use case, and since it is so common, Kontakt offers you a function that automates it for you. Just load or create an Instrument with multiple velocity layers, select all of your Zones in the Mapping Editor (take care that you don't accidentally select multiple overlapping Zones; you might want to use the Selected Groups Only switch), then select the **Auto add AET velocity morph** command from the Edit menu.

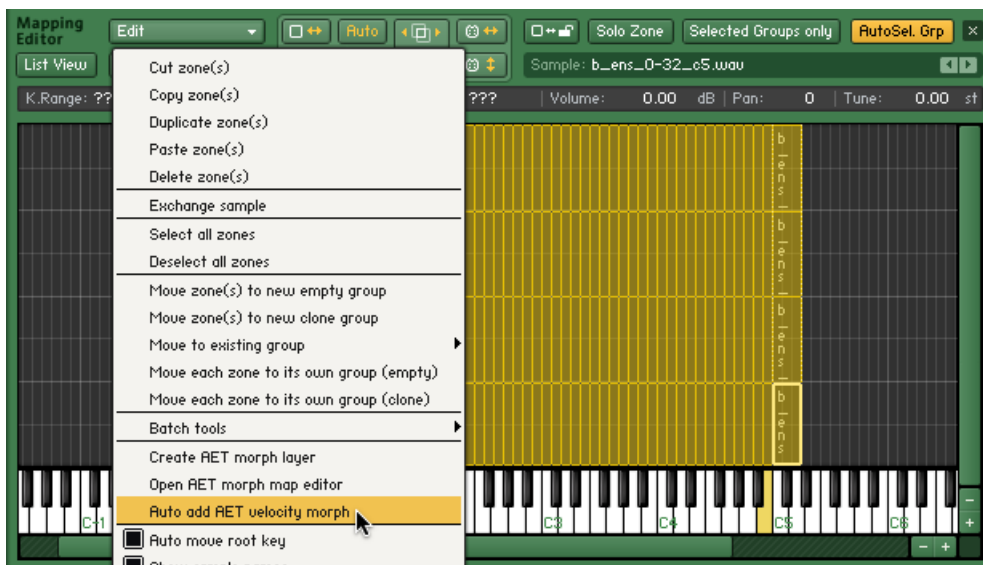

You can find the "Auto add AET velocity morph" function both in the Edit menu and in the right-click context menu of the Mapping Editor.

When you open the Group Insert FX chain now, you'll notice that Kontakt has added an AET Filter module for you. Take a look at its control panel and Modulation Router — it has already been set up with an auto-generated Morph Map, and the **Morph** knob is being modulated by the velocity.



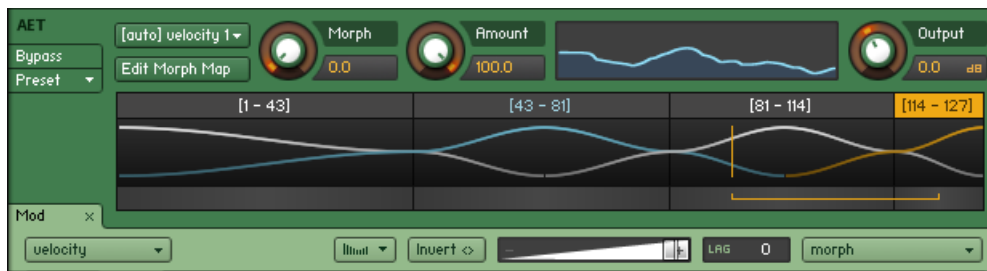

The “Auto add AET velocity morph” function will add a ready-to-use AET Filter module to your Group Insert FX chain.

When you play some notes, Kontakt will still only play the Sample that’s assigned to the incoming velocity; the further the actual velocity is away from the middle velocity value of the played Zone, though, the more of the spectral characteristics of the Zone directly below or above will now be imparted on the sound. Once the velocity crosses the border to another Zone, the process will be reversed; now the next Zone will play, with the frequency response of the preceding one being used for filtering. This way, the timbral differences of your velocity layers are elegantly masked, resulting in a smooth dynamic response over the whole velocity range.



Of course, nothing stops you from assigning other modulation sources than the velocity to the Morph knob; you can just as well use a continuous MIDI controller or aftertouch for this purpose. Using a different modulation source for morphing makes it possible to sweep through the morph gradient while the sound is playing, which opens up very interesting performance possibilities. Keep in mind, though, that the filter will only act upon the Sample that was triggered when you pressed the key.

## Creating an Articulation Morph

Setting up a simple velocity morph as described above is easy enough. There are times, though, when you need a more flexible way of configuring the morph filter. For example, you might want to set up a dynamically playable morph between two different, but musically related articulations of the same sound source, such as a choir singing “ahh” and “ooh”. This requires some more manual intervention. The procedure can be broken down into the following steps:

1. Create one Morph Layer for each of the Groups that the articulations are assigned to,
2. Combine two or more of these layers into a Morph Map, and
3. Load this map into an AET Filter module that you place in the Group Insert FX chain of the Group that should be processed.

In our example, we assume that the “ahh” and the “ooh” Zones are neatly split up into two different Groups, as would be the natural structure of a Kontakt patch. In a first step, select all Zones from the “ahh” Group (using the **Selected Groups only** function if needed), then choose **Create AET morph layer** from the **Edit** menu. A dialog window with a few options will appear.

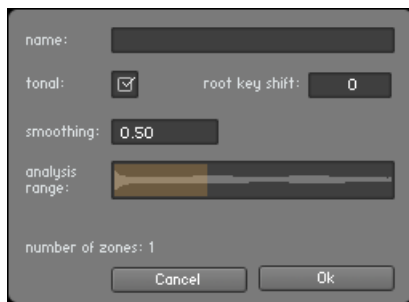

Before creating a new Morph Layer from the selected Zones, Kontakt asks you to specify some details about the process.

Enter a descriptive name for your layer (such as “ahh”) and make sure that both the Tonal option is activated and the Smoothing parameter is set to its default value of 0.5, then click **OK**. Kontakt will now generate spectral fingerprints of all Zones and save them in a new Morph Layer. Once it has finished, repeat the process with the Zones in the other group. You have now created two new Morph Layers that contain spectral information which will be used in the resulting morph.

In order to tell Kontakt which morph layers you’d like to use in your morph, you’ll have to create a new Morph Map and add those layers to it.

To add a new Morph Map:

1. Open the AET Morph Map Editor from the Edit menu; a dialog window with an input line on top will appear.
2. Combine your Morph Layers into Morph Maps with the AET Morph Map Editor.
3. Enter a descriptive name here (such as “ahh -> ooh morph”) and click the **Add** button. The Morph Layers you just prepared will now turn up in the right one of two lists at the bottom of the dialog, meaning that they’re available for inclusion in your new Morph Map. Select them one-by-one in the right list and move them into your map by clicking the left arrow button. Note that the order in which you include them is important; in our example, we want the filter to morph the original “ahh” samples into the frequency response of the “ooh” samples, so the “ahh” layer has to be on top of the list.
4. Before you finish, make sure you switch the Morph Map type to **articulation morph** instead of **velocity morph**; otherwise, Kontakt will display an error message, as velocity maps may only consist of a single Morph Layer. Click **OK**; your Morph Map is now ready for use.

Now would be a good time to stress the fact that in this scenario, the “ooh” samples will take no part whatsoever in the resulting sound; they just served as templates for setting up the morph filter. Even at the highest Morph setting, what you hear will actually be the “ahh” samples with the frequency response of the “ooh” samples superimposed. This also means that you should make sure that the “ooh” samples won’t be played when you press a key; the result would be a messy combination of filtered and unfiltered samples. The easiest way to do this is to turn the **Volume** knob of the “ooh” Group’s Amplifier Module all the way down.

To complete the process, switch over to the “ahh” Group, locate its Group Insert FX chain, and add an AET Filter module to an empty slot. Open the pull-down menu on the left side of its panel and select the Morph Map you just created. Now open the Modulation Router of the module and assign a controller, such as the modulation wheel, to the Morph parameter.

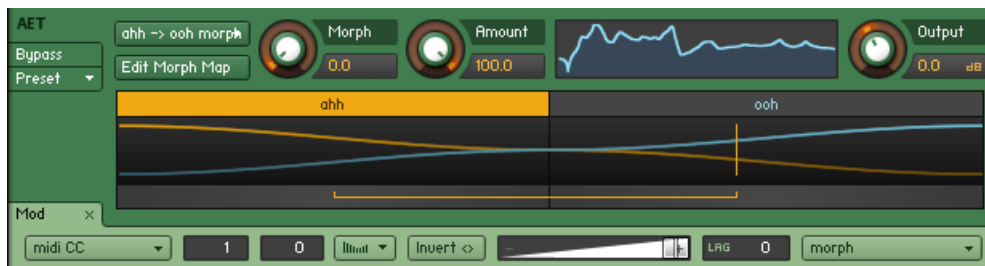

Setting the AET Filter module up in this way allows you to morph between your articulations in real-time using the modulation wheel.

That's it — when you play some notes now, you can seamlessly morph between “ahh” and “ooh” using the modulation wheel. Of course, you can also create morphs across more than two Morph Layers; by repeating the steps above, you could easily add another layer of the choir singing “mmh” to your patch.

Now that you know how to use AET in your own Instruments, we'll conclude this section with a description of the involved dialogs and their options.

## Create AET Morph Layer Dialog

This dialog appears when you select the **Create AET morph layer** command from the Edit or context menu of the Mapping Editor.

**Name:** The name of this Morph Layer, which will be used to identify it in the Morph Map Editor.

**Smoothing:** This value affects how much the analyzed frequency response will be smoothed out before it's being used as a template for the filter. Sensible values range from 0.1 (no smoothing) to around 2.0 (strong smoothing).

**Tonal:** When this option is active, Kontakt will analyze each sample harmonically in relation to the fundamental frequency of its respective root key value. You should only turn it off for material that's entirely non-tonal, such as noise or percussion, or in case the root key value is wrong; in that case, Kontakt will perform a plain frequency analysis with no respect to harmonic structures.

**Root Key Shift:** As described above, Kontakt will use the root key value of a Zone to determine its Sample's fundamental frequency when the Tonal option is activated. There are cases, though, where the root key value deliberately differs from the true fundamental frequency of the Sample. For instance, you could be working on a patch that places multiple playing techniques of the same instrument in different octaves, so that C2 and C4 play the same note, but with different articulations. In that case, using the root key value without correction would mislead the analyzer into considering the wrong frequencies; with the Root Key Shift parameter, you can specify an offset between the actual note of the Sample and its root key value in semitones. The default value of 0 assumes a correct root key setting; a value of -12 corresponds to the actual fundamental tone being one octave below the root key.

**Analysis Range:** Click and drag the borders of the selection range here to limit the analysis process to a certain time frame of each sample. When analyzing samples that change their timbre over time, this allows you to tell Kontakt at which point in a note the instrument will exhibit its most characteristic frequency spectrum, and exclude the rest from influencing the analysis result. For a piano or guitar, this would be the first seconds of each note; if you'd include the whole decay phase in the analysis, the average spectrum would turn out much darker.

**Number of Zones:** The number of Zones that are currently selected in the Mapping Editor and will be included in this Morph Layer when you click **OK**.

## Morph Map Editor

This dialog appears when you select the **Open AET morph map editor** command from the Edit or context menu of the Mapping Editor.

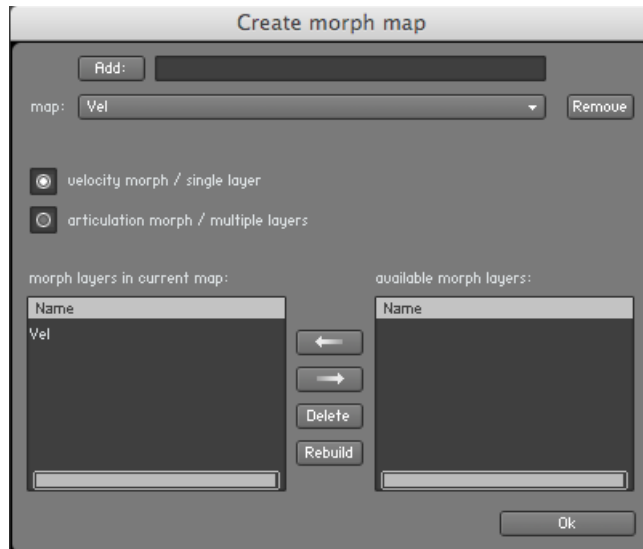

**Add:** Enter a name in the input field next to this button and click it to create a new, empty Morph Map.

**Map:** This pull-down menu contains all available Morph Maps of your Instrument. Select one to edit it.

**Remove:** Deletes the currently selected Morph Map from the Instrument, thereby bypassing any AET Filter modules that reference this map.

**Velocity/Articulation:** Specify the principal type of the Morph Map here. Velocity maps morph between the Zones of a single Morph Layer, while Articulation Maps morph between multiple Morph Layers. Refer to the previous subsection for a thorough discussion of the differences.

**Morph Layers in Current Map:** Contains the names of all Morph Layers that make up the current map. Selecting a layer and clicking the right arrow button removes it from the map.

**Available Morph Layers:** Contains the names of the Morph Layers available for inclusion in the current map. Selecting a layer from this list and clicking the left arrow button will add this layer to the Morph Map.

**Delete:** Selecting a Morph Layer from one of the lists and clicking this button will remove it from your Instrument.

**Rebuild:** This will re-open the Create Morph Layer dialog for the currently selected Layer, which allows you to readjust its analysis parameters.

## AET Filter Module Controls

This is the processing module that performs the actual filtering of the source material. When using AET via the **Auto add AET velocity morph** command, Kontakt will set this module up for you; in all other cases, you'll have to insert it into a Group Insert FX chain yourself.

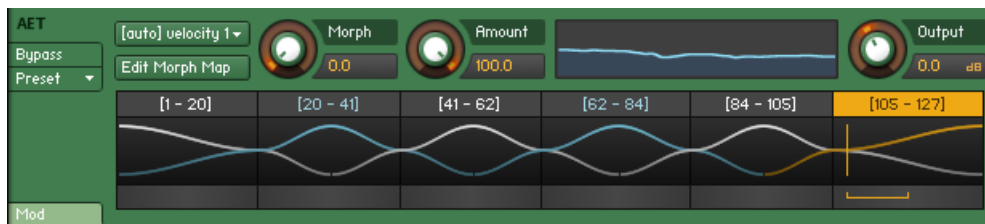

The control panel of the AET Filter module. Shown here is an auto-generated velocity morph across six layers.

**Morph Map:** Use this drop-down menu to load a Morph Map into the module.

**Edit Morph Map:** Click this button to open the Morph Map editor dialog explained in the previous section with the active Morph Map selected.

**Morph:** This is the most important parameter of the module; it should usually be modulated with an external source, such as the note velocity or a MIDI controller. Based on the contents of the selected Morph Map, Kontakt will build a continuous “morph gradient” that combines and connects the filter responses required to achieve the various timbres of the included Morph Layers with smooth transitions. Using the Morph parameter, you can set the filter to any point in this gradient. At its lowest value, the signal is changed towards the respective sample in the first Morph Layer of the map (if this happens to be identical with the playing sample, the filter will be flat); at its highest value, the sample is changed towards the respective sample in the last Morph Layer of the map. You can follow this behavior graphically in the morph curve view described below.

**Amount:** The amount to which the filter influences the resulting signal. At the lowest setting, the filter has no effect.

**Filter Curve:** This graph represents the actual, currently active filter response, which is the difference between the analyzed frequency response of the source (i.e. the currently playing Sample) and the target (i.e. the Morph Layer that appears in the Morph Map at the point that’s set with the **Morph** knob).

**Morph Curve View:** This is a graphical representation of the selected Morph Map and the resulting filter gradient. It’s divided into multiple color-coded sections and curves, with the sections depicting the Morph Layers that make up the map, and the curves representing the amount to which the frequency response of the respective layer will influence the final filter response at any point. On top of each section, the name of the respective Morph Layer is being shown for reference. At the peak of each curve, the currently played sample will be morphed into the frequency response of the respective layer to the maximum amount. The section and curve of the active sample (i.e. the source) are marked yellow; these correspond to a flat filter response. The sections and curves of the other layers are alternately colored white and blue. When playing a note and changing the Morph parameter, a horizontal, angled bracket below the graph marks the source and target points of the gradient that Kontakt uses to determine the final filter response.

**Output:** The output level of the module in dB.

## Gainer

This module can be used both within the Instrument Insert Effects chain and as a send effect. Depending on where you choose to place it, it serves two different purposes. As an Instrument insert effect, you can boost or attenuate the signal level between the previous stage’s output and the next stage’s input. In other words, it works like an additional amplifier stage.

The idea behind using the Gainer as a send effect needs some more explanation. As every send effect can optionally route its own output signal to one of the Aux Channels in the **Outputs** section (instead of feeding it back into the Instrument), the Gainer can act as a transparent bridge between the send slots and the Aux Channels. Therefore, it allows you to send signals at adjustable levels to the Aux Channels on a per-Group basis, which greatly increases routing flexibility and can even save a lot of CPU resources – just move effects that you would otherwise have created as send effects in multiple Instruments to an Aux Channel instead, and use the Gainer within the Instruments' send effects slots in order to forward signals to this Aux channel. By changing the Aux channel's physical output assignment, you can even use external effects, whether they are plug-ins in your host program or outboard devices, from within Groups.

After you have inserted the Gainer module into a send slot, you'll notice that in addition to the Gain control, it also provides the Return control which is common to all send effects on the right side of its panel. Next to the numerical readout of this control, you'll notice a small „I“ icon. Clicking on it opens a drop-down menu that allows you to select one of the Aux Channels as the routing target for the module's output. This way, whatever you'll send to this slot via the Send Levels module will end up on the specified Aux Channel.

Gainer contains the following control:

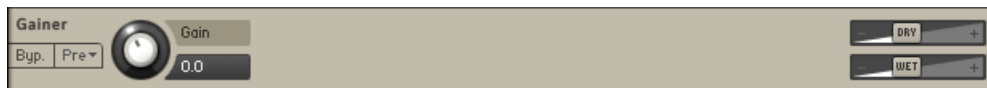

- **Gain:** The amplification or attenuation factor that will be applied to the signal in dB.

## Inverter

With this module, you can invert the phase of your audio signal, or swap the left and right channels. Since the Inverter only makes sense as an insert effect, you can use this module only in the Group Insert Effects and Instrument Insert Effects chains.

Inverter contains the following controls:



- **PhaseInvert:** Inverts the signal phase polarity.
- **Pan L <> R:** Swaps the stereo channels.

## Send Levels

This utility module can be added to the Group Insert Effects and Instrument Insert Effects chains and allows you to send a signal from within the insert chain to any existing send effect at adjustable levels.

This module contains the following controls:

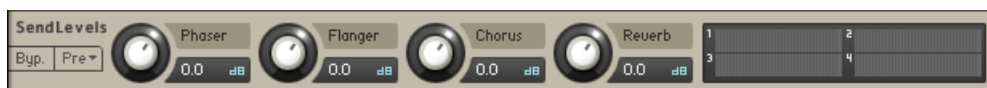

- **Levels:** On the left side of the Send Levels module, you'll see a level control for each send effect that's currently in one of your Instrument Send Effects slots — if you didn't add any send effects yet, the panel will be empty. The knobs allow you to adjust the level at which the signal will be sent to the respective effect.
- **Level meters:** These LED-style peak meters provide visual feedback on the send levels.

# 13. Modulation

Kontakt's internal modulation system offers a powerful way to "animate" parameters, making them change over time in a variety of different and finely adjustable ways. For this purpose, most of Kontakt's modules provide a table, called the Modulation Router, which allows you to assign various sources of modulation signals to that respective module's parameters.

If you're new to synthesizers and samplers, you might be unfamiliar with the concept of modulation, so we'll explain it briefly. If you already have worked with modulation, just skip the next paragraph.

Suppose you have a very simple tone generator with only one control, which changes the pitch of the generated tone. As players of acoustic instruments often use vibrato — a subtle "trembling" of the pitch — as a means to make their sound more expressive and dynamic, you'd like to simulate this effect with your generator. Of course, rapidly moving the pitch knob left and right is an option, but this is awkward and inconvenient. Instead, you can use another generator that outputs a periodic waveform as well — though at a much lower frequency than your tone generator, let's say 5 Hz — and connect it to the pitch control of your tone generator. Now, the tone generator's pitch will begin to periodically sweep up and down "around" the pitch you've adjusted with the knob, in other words: vibrato. This is a very simple example of modulation: you're using a generated control signal (which can be periodic, but doesn't have to) to change some parameter over time. Of course, the example can be just as easily replicated in Kontakt: the Source Module will become your tone generator, its Tune parameter your pitch knob, an LFO your source of a low-frequency control signal, and an entry in the Modulation Router the wire that connects both generators.

## Modulation sources

Kontakt's library of sources that can be used for modulation is divided into four general categories:

- **Envelopes** are finely adjustable curves of varying shapes, which have a beginning and an end; these are usually being used for creating parameter changes, often non-repetitive, that can't be easily obtained from a traditional periodic waveform, such as a filter that opens and then gradually closes again after a key has been pressed. Envelopes generally react to MIDI note messages.
- **LFOs** (Low Frequency Oscillators) are sources that generate a periodic waveform within a frequency range of 0.01 Hz up to about 210 Hz. In addition to the traditional set of waveforms found on synthesizers — namely **Sine**, **Triangle**, **Rectangle**, **Sawtooth**, and **Random** — Kontakt also provides a complex LFO, which generates a mixture of these waveforms.
- **External Sources** provide access to control signals that are generated outside of Kontakt's modulation source modules, such as incoming MIDI data, or constant and random values.
- **Others** include sources that don't fit into one of the other categories, such as step sequencers or envelope followers.



While control data obtained from external MIDI messages is constrained to the 128 numerical steps of the MIDI standard by its very nature, Kontakt's internal modulation sources offer a much finer resolution.



## Modulation destinations

Modulation Routers can be found on most modules that work on a per-Group basis; this includes the Source and Amplifier modules, as well as signal processing modules in the Group Insert Effects chain. Furthermore, modulation source generators used in existing assignments can have their own parameters modulated as well, which makes for a multitude of complex possibilities.

Modules outside the Group level, such as Instrument Insert Effects, Send Effects and Main Effects, do not support parameter modulation.

In the same way as you can use one modulation source to modulate multiple parameters, you can also combine multiple sources to modulate one parameter. If you create multiple assignments with the same destination parameter, the modulation signals will be mixed together – keep in mind, though, that a lot of modulation signals are bipolar, and thus can cancel each other out as well as accumulate their values.

## Creating modulation assignments

Each modulation assignment that actively affects a specific parameter at any given time will be displayed with a single row in the Modulation Router of the parameter's parent module. The Modulation Router can be shown and hidden by clicking on the button labeled **Mod** or **Modulation** in the lower left corner of a module. If this button does not exist, the respective module's parameters can't be modulated.



*The Modulation Router of an Amplifier Module*

If a Modulation Router entry uses an internal modulation source for the assignment, you'll always find a corresponding modulation source panel at the bottom of the Rack in Instrument Edit mode; here you can adjust the parameters of the signal source, such as an LFO's frequency or envelope timings.



The Modulation section contains all internal modulation sources used in your Instrument.

You don't need to scroll up and down to make adjustments to a modulation source and its Modulation Router entry, though; clicking one of the Quick-Jump buttons on both panels or simply pressing the "A" key ("~" on US keyboards) will instantly bring you to the respective other panel.



The Quick-Jump button on Modulation Router entries and modulation source panels brings you to the respective other panel.

Adding a new entry to a Modulation Router table, thereby creating a new modulation assignment, can be done in one of two different ways. Which one you choose largely depends on your personal preference.

1. Right-click the knob of a parameter that you want to modulate, then choose a modulation source from the drop-down menu which appears. The submenu at the bottom of this menu contains modulation sources which already exist in your Instrument (if any), and allows you to assign an existing source to more than one parameter. If the module's Modulation Router is not currently visible, adding a new assignment will show it. This allows you to make immediate adjustments to the assignment parameters.
2. Open the Modulation Router of a module and click the Add Modulator button on the left side of its last row. This will open the same drop-down menu of modulation sources that you'll get when you right-click a knob. Since you can't specify a destination parameter this way, you'll usually have to change the modulated parameter via the drop-down menu on the right side of the new assignment entry.

## Deleting modulation assignments

To get rid of a modulation assignment entirely, select its entry in the Modulation Router by clicking on its panel, then press the Delete key on your keyboard. If the assignment was using an internal signal source, and no other assignments in your Instrument are using the same source, the corresponding source panel will disappear from the **Modulation** section of the Rack as well.

You can also right-click on the modulation assignment and select **Delete** from the context menu.

## Assignment controls

As mentioned, all controls which affect the behavior of a modulation source can be found on the respective source panel at the bottom of the Rack. There are additional parameters, though, that affect in which way this source module's output signal will be mapped to the parameter to which it has been assigned. Since a source can be used to modulate multiple parameters in different ways, it wouldn't make much sense to include these controls on the panel of the source; instead, they're a part of each assignment entry in the Modulation Router table.



From top to bottom, this Modulation Router contains entries for a volume envelope, a velocity-to-volume mapping, and a mapping which uses MIDI CC #69 data for the panorama position, with using the far left as default.

- **Modulation Source:** If the entry belongs to an internal source assignment, this value can't be modified, but external source assignments will offer a drop-down menu here that allows you to switch to a different source.
- **Quick-Jump button** (only visible on internal source assignments, like LFOs): Clicking on this button will immediately scroll down to the respective source's control panel at the bottom of the Rack. Once you're finished with your adjustments down there, the identical button on the panel will bring you back to where you came from.
- **MIDI CC Number** (only visible if source is **MIDI CC**): The modulation will acquire its values from incoming MIDI controller data with the number specified here. The modulation wheel usually sends MIDI CC #1 data, volume and expression pedals CC #7 and #11, respectively.
- **MIDI CC Default Value** (only visible if source is **MIDI CC**): As a MIDI controller's current position can't be queried remotely and is thus unknown until actual data is received, this value will be used as a substitute until the first MIDI CC data is seen. A value of -1 in this field tells Kontakt not to modulate the parameter at all until actual data is received.
- **Modulation Shaper:** If you need more control over the relationship between modulation signals and parameter changes than what's provided by the **Intensity** fader, clicking on this button will open a shaper table, which allows you to create all sorts of custom shapes — from non-linear transfer curves all the way to complex tables that assign each possible input value to a different output value.

## The Modulation Shaper

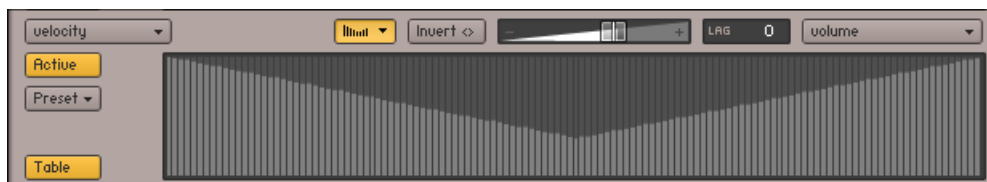

*A modulation shape which changes low velocity values to higher ones.*

- The **Active** button in the upper left corner of this view activates the shaping of the modulation signal. When switched on, the window next to it will show a graphical representation of the table that's made up of 128 vertical bars, with each bar's height representing the actual value that will be used for modulation if the value that corresponds to this bar is received from the source module. In other words, what you see is a transfer curve, whose X axis represents the input value, and whose Y axis represents the output value.  
By clicking and dragging a single bar, drawing shapes across bars, or drawing lines by right-clicking and dragging the mouse, you can quickly create your own shapes. Note that holding the [Shift] key while changing the height of a bar allows for finer editing, while [Ctrl]-clicking on bars ([Cmd]-click on Mac OS X) will reset them to zero.
- **Table:** When active, the Modulation Shaper provides an alternate editing mode for non-linear curves and other deterministic shapes that are not easily drawn with any accuracy using a mouse.



When using this Table mode of editing the modulation shape, you have the option to import and export the table data as a text file. To open the export dialog, [Shift]-click the **Active** button; and to open the import dialog, use [Shift] + [Ctrl] on Windows or [Shift] + [Cmd] on Mac OS X.



The curve editor allows you to create continuous, smooth modulation shapes.

- **Table:** When deactivated, you can define your mapping using curve segments. This editor mode works similarly to the flexible envelope editor described in section [Flexible Envelopes](#). You can drag the endpoints of curve segments to move them, drag the circles in the middle of a segment to change the curve shape, right-click [Ctrl](macOS) + click on an endpoint to delete it, and right-click [Ctrl](macOS) + click somewhere else to create a new segment.
- **Invert button:** If this button is activated, all modulation will be reversed in direction; so a rise in the modulation signal will result in a proportional drop in parameter value.
- **Modulation Intensity:** This fader controls how large the parameter changes caused by the modulation signal changes will be, or in other words, how far this assignment will cause the parameter to stray from its original value. As different modulation intensities can produce considerably different effects, this is probably the most important parameter of the assignment. As an example, reconsider the LFO-to-pitch assignment described in the previous section: a natural and subtle instrument vibrato will call for a rather low intensity value, while a higher intensity will produce a sound reminiscent of a police siren.
- **Lag (Smoothing):** If this value is higher than 0, any signal received from the modulation source will be smoothed. The displayed value is a time constant in milliseconds and indicates how long the smoothed signal would take to reach the new value after an instantaneous change in the modulation signal occurred. The most obvious application of this feature is a gentle smoothing of external MIDI data; as the MIDI standard imposes a resolution of only 128 steps on controller data, using it without smoothing is prone to causing audible parameter jumps. A fairly low smoothing value will get rid of these, while still preserving a sufficiently fast response to controller changes. As pitch modulation is particularly prone to audible steps, all pitch assignments will have their Smoothing parameter set to a value of 250 by default. Higher values can give useful results with LFOs, such as a “slurred” rectangle or sawtooth modulation.

- **Modulation Target:** Finally, the rightmost element displays the parameter that will be modulated. If you click the field, a drop-down list of all parameters that can be modulated in this module will appear, and you can choose a new target.

## Modulation source reference

The following sections describe all modulation sources that Kontakt has to offer. All modulation sources fall in one of four general categories: Envelopes for (usually) non-periodic, finely adjustable curve shapes, LFOs for periodic waveforms, Other for special modulators like step sequencers, and External for modulation signals that don't originate from one of Kontakt's modulation modules.

### Envelopes

Kontakt offers three kinds of envelope shapes, each one with a different set of controls:

- **AHDSR:** This is Kontakt's take on the most common envelope type out there, the ADSR envelope, which is named after its parameters (attack time, decay time, sustain level, and release time). With these four parameters, ADSR envelopes can create a surprisingly large number of different modulation shapes, which are well-suited to simulate the natural dynamic behaviors of acoustic instruments. Kontakt's flavor of this envelope provides an additional **Hold Time** control, which will be described below.
- **DBD:** This is a rather simple one-shot envelope that rises or falls from zero to an adjustable breakpoint above or below, then returns to zero. It works well for simulating things that happen during the initial attack phase of sounds.
- **Flexible Envelope:** As the name suggests, this envelope doesn't force any limitations whatsoever on your modulation shape. It allows you to create almost arbitrarily complex controller curves, which span anything from milliseconds to several minutes.

### AHDSR

The AHDSR (Attack, Hold, Decay, Sustain, Release) envelope contains the following controls:



- **AHD Only:** If this button is activated, the envelope will be reduced to its attack, hold, and decay phases (see below for a description of what these do). As this eliminates the sustain parameter, what you'll get is a simple one-shot envelope, which will always be completed no matter how long the key is being held. It is thus best suited for drum and percussion sounds.
- **Retrigger:** If this button is activated, the envelope will be restarted every time Kontakt receives a note, even if another note is still being held at the same time. If it's inactive, the envelope will keep its current position until the last note has been released, then be restarted on the next note.
- **Curve:** Adjusts the curve shape of the attack phase. A value of zero results in a linear attack curve, negative values make the shape more concave, and positive values make it more convex.
- **Attack:** The initial time it will take the envelope to reach its maximum level after it has been triggered.

- **Hold:** The (fixed) time the envelope will stay at its maximum level after it has completed the attack phase and before it enters the decay phase.
- **Decay:** The time it will take the envelope to fall from its maximum level to the level set by the **Sustain** control.
- **Sustain:** After it has completed its attack, hold, and decay phases, the envelope will stay at this level as long as the key is being held.
- **Release:** The time it will take the envelope to fall from its sustain level back to zero after the key has been released.

## DBD

The DBD (Decay, Break, Decay) envelope contains the following controls:



- **Retrigger:** If this button is activated, the envelope will be restarted every time Kontakt receives a note, even if another note is still being held at the same time.
- **Decay 1 (D1):** The time it will take the envelope to rise or fall from zero to the breakpoint after it has been triggered.
- **Break (B):** The level of the breakpoint. If this value is negative, the envelope will fall, then rise, and behave the other way around if it's positive.
- **Decay 2 (D2):** The time it will take the envelope to rise or fall back to zero after it has reached the breakpoint.
- **Easy Mode:** In Easy Mode, the DBD Envelope's Break and Decay 2 parameters are de-activated, leaving just one parameter: **Decay 1**. The breakpoint will be set to zero. The Easy Mode is generally easier to work with than the full mode for basic percussive instruments.

## Flexible Envelopes

This powerful envelope type allows you to create arbitrary modulation shapes by defining up to 32 breakpoints, each at a defined level and point in time. Similar envelopes appear in a few other places of Kontakt, for instance as Zone Envelopes in the Wave Editor.

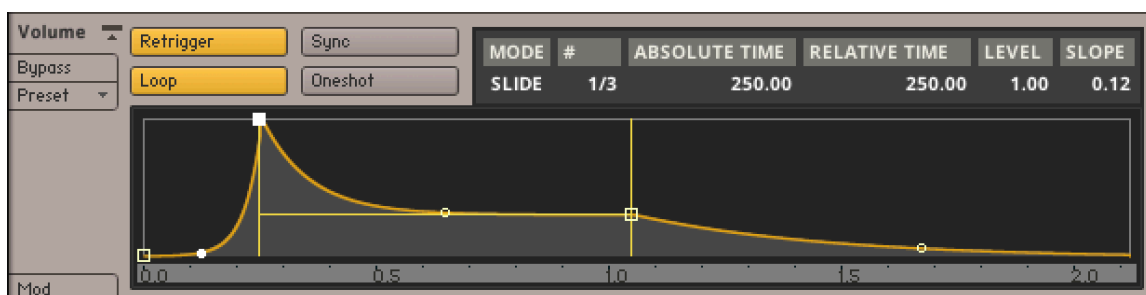

When you create a new flexible envelope, you'll initially see a shape which roughly resembles a traditional ADSR envelope in its panel. Any changes to the shape of the envelope will take place within this graphical representation. Just like within the other envelope editors, the X axis represents the time, while the Y axis represents the modulation level.

You can define an envelope shape by creating or deleting breakpoints, moving them around (thereby changing their position in time and their level), and changing the shape of the curves that connect them. The initial preset is an envelope with four breakpoints; this is also the minimum number of breakpoints that have to be present in an envelope.

In order to add a breakpoint to your envelope, right-click (Windows) or [Ctrl] + click (macOS), on the position where you want it to be created. Deleting breakpoints works in the same way: right-click (Windows) or [Ctrl] + click (macOS) on an existing breakpoint will delete it, causing its neighbors (if the breakpoint wasn't the last one of the envelope) to be connected with a straight line. You can change these connections between breakpoints from straight lines to convex or concave curves by dragging the small circles in their middle up or down.

If your envelope is becoming longer than the time window that's currently being displayed in the editor, you can left-click and drag the time line horizontally to scroll, or right-click (Windows) or [Ctrl] + click (macOS) and drag it to zoom in and out.

You can move breakpoints around by dragging them with the mouse. The currently selected breakpoint will be indicated with a filled square icon. In addition to its graphical position in the editor, you can view its parameters as numerical values in the breakpoint status line above the editor.

MODE	#	ABS. TIME	DELTA TIME	LEVEL	SLOPE
SLD	1/3	250.00	250.00	1.00	0.13

The status bar of the flexible envelope panel displays data of your currently selected breakpoint in numerical form.

These values indicate the current positioning mode, the number of the currently selected breakpoint, its absolute position in time (displayed in milliseconds), its relative distance in time to the preceding breakpoint, its level, and the shape of the curve to the left of the breakpoint (with a value of 0.5 indicating a linear shape, higher numbers indicating a convex shape, and lower numbers a concave shape).

When you move any point (except the last one) horizontally, all points that follow it will move along by the same amount, thereby changing the overall duration of the envelope. To deactivate this feature, click the Mode entry of the breakpoint status line above the envelope editor; this will toggle the breakpoint positioning mode:

- **SLD:** Slide mode is the default setting and shows the described behavior.
- **FIX:** Fixed mode allows independent positioning without affecting other breakpoints.

In addition to the envelope shape, the editor displays three orange lines; two vertical, one horizontal, drawn in a "H" shape. The section between the vertical lines, which can be dragged to other breakpoints (except the first and last point of the envelope), marks the envelope's sustain phase. This phase affects how the envelope will behave while a note is being held. What exactly will happen during this time depends on whether there are any additional breakpoints between the two orange lines. If the sustain part spans only the curve between two breakpoints, with no other breakpoints in between, the envelope will "freeze" when it reaches the second point's level – indicated across the sustain part with the horizontal orange line – while the note is being held. In contrast, if there are any additional breakpoints between the start and end markers of the sustain phase, the whole section will be looped until the note is released, in which case the envelope immediately jumps to the section that follows the sustain phase.

The first 8 breakpoints of a flexible envelope are special in that their positions in time and their levels can be modulated via external modulation sources; to do this, open the envelope editor's Modulation Router and create modulation assignments in the usual way. The slope of these first 8 segments can also be modulated.

Now that you know how the envelope editor works, let's have a look at the four remaining buttons of the panel:

- **Retrigger:** If this button is activated, the envelope will be restarted every time Kontakt receives a note, even if another note is still being held at the same time.
- **Tempo Sync:** When activated, a vertical grid of note values will be drawn on top of the editor, the step size of which will depend on your current zoom factor (remember you can zoom in and out horizontally by right-clicking or [Ctrl]-clicking and dragging your mouse on the time line). All breakpoints you move around in this mode will snap their position in time to these grid lines, allowing you to create modulation curves in sync to your host or Master Editor tempo. Since this will make the actual length of your envelope change with the host tempo, the breakpoint timing values that were previously displayed in milliseconds will now be displayed in note divisions.
- **Loop:** When activated, the two gray vertical lines in the editor will turn yellow. The envelope segments within the range defined by these lines will loop during the sustain phase of the envelope.
- **Oneshot:** When active, the envelope will always play through to the end, ignoring key release. When inactive, the envelope will jump to the release phase (indicated by the rightmost vertical line) when a key is released. When both **Loop** and **Oneshot** are active, the envelope will play indefinitely.

## LFOs

Low Frequency Oscillators (LFOs) generate periodic (or in some cases, random) signals, which are typically used for modulation across all kinds of synthesizers and samplers. Their name stems from the modular analogue synthesizer behemoths of the past, where they first originated: it was meant to reflect that their typical operating frequency was the only thing that set them apart from the audio oscillators (which were mostly just being referred to as “oscillators”), since otherwise, they worked pretty much the same, and had similar controls. While audio oscillators generate signals in the audible range of 20 Hz up to 20,000 Hz, LFOs provide a much lower range. This aspect makes sense when you consider that most practical parameter modulations call for speeds that are actually humanly perceivable as changes, not as continuous sounds. Take the canonical vibrato example from the last chapter – even 20 Hz would be much too fast for a vibrato, so the actual frequency is actually far outside the useful audio range.



An LFO, outputting a sine waveform at 1 Hz.

All of Kontakt’s LFOs can generate frequencies within the range of 0.01 Hz to around 210 Hz. You’ll notice that the upper part of this range actually overlaps the audio range, which opens up some rather interesting and creative modulation possibilities, but the better part of your traditional LFO assignments will likely call for frequencies between 0.01 Hz and 40 Hz.



A Multi LFO, which lets you mix all other waveforms into a complex waveform.



Depending on their output waveform, these LFOs will all look slightly different, however they should not be treated like separate modules. Once you have created an assignment that uses an LFO as its source, you can conveniently switch the waveform on this LFO's control panel in the **Modulation** section of the Rack; the displayed set of controls will follow your selection. The following section explains every control only once, with an appropriate remark if a control is specific to a waveform.

## LFO controls

LFOs contain the following controls and options:

- **Waveform:** Displays the waveform of this LFO's output signal and allows you to select a different one via a drop-down menu. The available waveforms are Sine, Triangle, Rectangle, Sawtooth (falling), Random, and Multi, which is a mixture of all other waveforms.
- **Retrigger:** If this button is activated, the LFO waveform will be restarted at the same position each time a note is received. If it's inactive, the LFO will run in a "freewheel" fashion, without reacting to notes.
- **Freq:** Adjusts the frequency of this LFO's output signal in Hz (cycles per second). Values range from 0.01 Hz (one cycle in 100 seconds) to around 210 Hz.
- **Sync** (unit icon): The LFO speed can be synchronized to your host tempo, an external MIDI clock, or your Master Editor tempo. To accomplish this, click the displayed unit of the frequency readout. A drop-down menu will appear, allowing you to choose from a list of note values. After you've selected a value, the LFO is in sync mode, and the frequency control will adjust and display how many notes of this value will make up the duration of one cycle. For instance, if you select Whole and dial in a value of 1.0, an entire LFO cycle will span exactly one bar of a 4/4 measure. To return to unsynchronized mode, just select Default from this drop-down menu.
- **Fade in:** If this value is greater than zero, the LFO will not start the waveform right away when a note is received, but rather smoothly ramp it up over a time of up to 5 seconds. This works great on human-like vibratos. Like the frequency control, this parameter can be synchronized to a song tempo in the way described above.
- **Start Phase:** Adjusts the position within a cycle at which the LFO will start its waveform when it's triggered. The value is displayed in degrees, with 0° being the start of the waveform, 180° the mid-point of the cycle, and 360° the start of the next cycle. Setting this parameter only makes sense when the **Retrigger** button is activated.
- **Pulsew.** (Pulse width, **Rectangle** waveform only): The pulse width adjusts the duty cycle of the waveform, which determines the ratio between the high and low parts of the cycle. A pulse width of 50% results in a perfect square wave.
- **Waveform Mixer** (Multi waveform only): The Multi waveform is special in that it's the result of an addition of other waveforms. Which waveforms will appear in this mixture, and at which respective amounts, can be adjusted with an additional set of controls which appears below the main row of knobs when you switch to the **Multi** waveform. Note that these mix controls are bipolar and thus allow you to reverse the polarity of source waveforms. At a value of 0.0, the respective waveform will be absent from the mixture.
- **Normalize Levels** (Multi waveform only): If this button is activated, and the sum of all component waveforms in the current mixture would exceed the level of a simple waveform at its peaks, the LFO will reduce its level accordingly.

## Multi Digital

The Multi Digital LFO is a new LFO type with identical controls to the standard Multi LFO. The difference is in the signals themselves; the standard Multi LFO approximates analog signals, including ripples in signals with sudden value changes (like Rect and Saw), while the new Multi Digital LFO is more mathematically accurate. This is particularly useful for creating precise, rhythmically complex modulation sources.

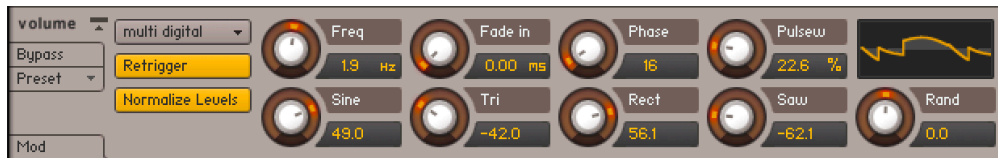

A Multi Digital LFO.

## Other modulators

This category includes all internal modulation sources that won't fit into one of the other categories.

## Step Modulator

The Step Modulator works similarly to a classic step sequencer in that it allows you to freely define a row of up to 32 values, which will then be “played back” at a constant speed. You can define these bipolar values by drawing bars that originate from the middle line with your mouse; the higher a bar, the further the modulated parameter will stray from its original value at this point in the row. To draw a linear change across multiple bars, right-click ([Ctrl]-click on Mac OS X) and drag the mouse in your editor; this will draw a line which will be reproduced with bars when you release the mouse button. The speed at which the Step Modulator will move from bar to bar can be synchronized to your host or Master Editor tempo.

The Step Modulator contains the following options and controls:

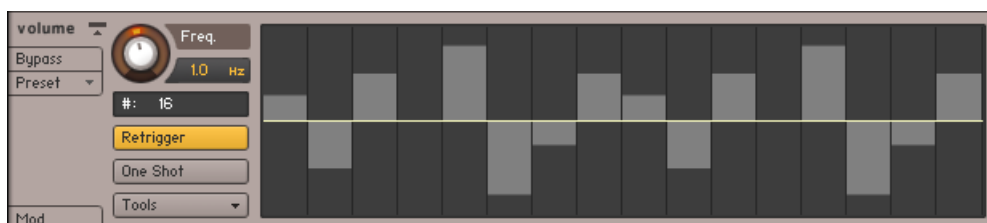

- **Freq:** Adjusts the “playback speed” of the Step Modulator. Values range from 0.01 Hz (an entire cycle through all bars will take 100 seconds) to around 210 Hz. You can synchronize the speed to your host or Master Editor tempo by clicking on the displayed unit, then choosing a note value from the drop-down menu and adjusting the speed knob to a number of these note values that will be spanned by one cycle.
- **# (number sign):** Determines the number of steps in the sequence. Click this field, then drag your mouse up or down to change the number of steps in your row. As the modulator will immediately wrap to the first row after it has reached the end, a power of two in this field (like 8, 16 or 32) will ensure that the Step Modulator keeps aligned with a binary song meter during playback.
- **Retrigger:** If this button is activated, the Step Modulator will restart its sequence at the first bar each time a note is received. If it's inactive, the step modulator will run in a “freewheel” mode without reacting to notes.

- **One Shot:** If this button is activated, the Step Modulator will play the row once, then stop. Otherwise, it will loop the row indefinitely.
- **Tools:** Opens a drop-down menu with two utility functions: **Reset** will set all step amplitudes to 0, **Snap 1/12** will restrict all edits to a grid of 24 steps (12 in each direction), which, in combination with a pitch assignment with full modulation intensity, allows you to create note sequences within a chromatic scale.

## Envelope Follower

The Envelope Follower continually analyzes the amplitude of the currently played sample and generates a modulation signal from it, thereby replicating the dynamic envelope of the audio signal for your own use. In other words, whenever your audio signal gets louder, the modulation signal will rise accordingly; when it gets quieter, the modulation signal will fall.

The Envelope Follower contains the following controls:



- **Attack:** Adjusts the Envelope Follower's response time to rising levels. Larger values will "smooth out" the attack phases that correspond to increasing audio levels. Very short values can cause distortions, as the Envelope Follower will begin to track each cycle of the audio waveform.
- **Decay:** Adjusts the Envelope Follower's response time to falling levels. Larger values will "smooth out" the decay phases that correspond to decreasing audio levels. Very short values can cause distortions, as the Envelope Follower will begin to track each cycle of the audio waveform.
- **Gain:** Adjusts the Envelope Follower's sensitivity to the audio signal. Larger values result in a higher envelope amplitude.
- **Adapt:** Sets a baseline transient response time for the Envelope Follower.

## Glide

The Glide module acts as a source for a special modulation signal that's needed to create a portamento effect. This effect is known from monophonic synthesizers and adds a sliding transition between the pitches of two consecutive notes when they are played in a legato fashion. To create a portamento, assign the Glide module to the pitch of your source module, and set the corresponding modulation intensity to the maximum value. Using this module in other ways rarely makes sense. Also note that while using this facility with polyphonic Instruments certainly works, the effect is usually associated with monophonic Instruments.

The Glide module contains the following controls:



- **Time/Speed:** Selects one of two different glide modes. If Time is selected, all transitions happen in the same time, regardless of the interval between the notes; in Speed mode, wide-spaced intervals will result in longer transitions than close-spaced intervals, as the glide speed will be kept constant.

- **Speed:** Adjusts the speed of the portamento. You can synchronize this parameter to your host or Master Editor tempo by clicking on the displayed unit, then selecting a note value from the drop-down menu and adjusting a numerator for this value with the speed knob.

## External sources

This category encompasses modulation sources whose signals don't originate from one of Kontakt's source modules; most of the sources found in this category reference incoming MIDI data of any sort, allowing you to use data like pitch bend, aftertouch, or MIDI controllers for parameter modulation.

The External category contains the following options and controls:



*An external modulation assignment which maps MIDI Velocity to the volume parameter of an Amplifier Module.*

- **Pitch Bend:** This kind of MIDI data is usually sent by pitch bend wheels or levers on master keyboards. Unlike normal MIDI controllers, pitch bend data is transmitted in a rather fine resolution of 14 bit, which provides 16,384 value steps. If both your controller and the parameter that you'd like to modulate can work with this resolution, Kontakt will use it to its full extent.
- **Poly Aftertouch:** This controller, also referred to as key pressure, is sent by a rather small number of MIDI keyboards and allows you to receive aftertouch pressure data for individual keys. Note that in order to create an Instrument that responds to polyphonic aftertouch, you'll need to spread your voices across multiple Groups that are cycled in a round-robin fashion, so that the pressure of each key can be processed within its own group.
- **Mono Aftertouch:** This controller, which is also being referred to as channel pressure, provides a single value for the aftertouch pressure that's applied to held keys. It's sent by a wide range of master keyboards.
- **MIDI CC:** The MIDI specification provides 128 continuous controllers (0-127) for general use. These are supported by almost all MIDI controller devices and used for transmitting the status of controllers like modulation wheels, sustain and volume pedals, or general purpose fader banks. Some controller numbers are assigned to standard devices (#1 = modulation wheel, #7 = volume, #11 = expression, #64 = sustain pedal, to name a few), but Kontakt doesn't take that into account — you can use all controller numbers between 0 and 127 as modulation sources.
- **Key Position:** This source provides access to the MIDI note number of a pressed key. It can be used to change parameters, like a filter cutoff, in response to the pitch of the played note in order to make keyboard tracking possible.
- **Velocity:** This is a value between 0-127 that indicates how hard (technically, fast) a key has been hit. It's transmitted by nearly all master keyboards and is frequently being assigned to parameters like volume, brightness, or (inversely) the length of the attack phase.
- **Release Velocity:** This value is sent by a rather limited number of master keyboards. It indicates how slow or fast a key is being released and is useful for changing the length of a sound's release phase accordingly.
- **Release Trigger Counter:** This value is generated for Groups that are being triggered on release and indicates the time between the trigger and the release signal. Read the description of release triggers in [Source Module](#) for an in-depth explanation of this facility.

In addition to external MIDI data, the **External** category also includes 3 special sources of scalar values that won't change over time:

- **Constant** will simply add or subtract the value of the modulation intensity fader to the modulated parameter. It can be used to easily “bend” parameter values beyond the range limits of their controls.
- **Random Unipolar** will generate a random value between 0 and 1 for each received note.
- **Random Bipolar** will generate a random value between -1 and 1 for each received note.
- **From Script** is a special modulator which responds to per-event generated modulation data from Kontakt's script processor. See the [KSP manual](#) for more information.

# 14. MIDI Learn

Kontakt features a MIDI Learn function for all sliders and knobs. This allows you to assign parameters to a MIDI device and access them via MIDI, as well as the interface.

**i** New instruments created with NativeUI currently only support assigning parameters to a MIDI device using the **Learn** button in the Automation tab. Refer to [Assigning MIDI Controllers via the Learn button](#).

## Assigning MIDI controllers

To assign any of Kontakt's sliders or knobs to a MIDI controller:

1. Right-click the knob or slider you want to assign.
2. Select **Learn MIDI CC# Automation**.
3. Turn the knob or move the slider on the MIDI device.

→ The control detects the movement instantly and the parameter is assigned to the MIDI controller.

Multiple MIDI controllers (CC#s) can be added to the same Kontakt knob. You can also assign multiple knobs or sliders to the same MIDI controller.

**i** If you cannot assign MIDI controllers using this method, refer to the [Automation Tab](#) for an alternative assignment method.

## Removing MIDI controller assignments

To remove a MIDI controller assignment:

1. Right-click the knob or slider from which you will remove MIDI assignments.
2. Select **Remove MIDI Automation: CC#**.

→ The MIDI controller assignment is removed.

# 15. Options dialog

The Options dialog lets you configure Kontakt's global preferences, such as user interface settings, audio and MIDI options, as well as file management. Preferences are divided into categories which you can access using the tabs on the left side.

- ▶ To open the Options dialog, click **Options...** from the **File** menu in the Header, or press F12 on your computer keyboard.

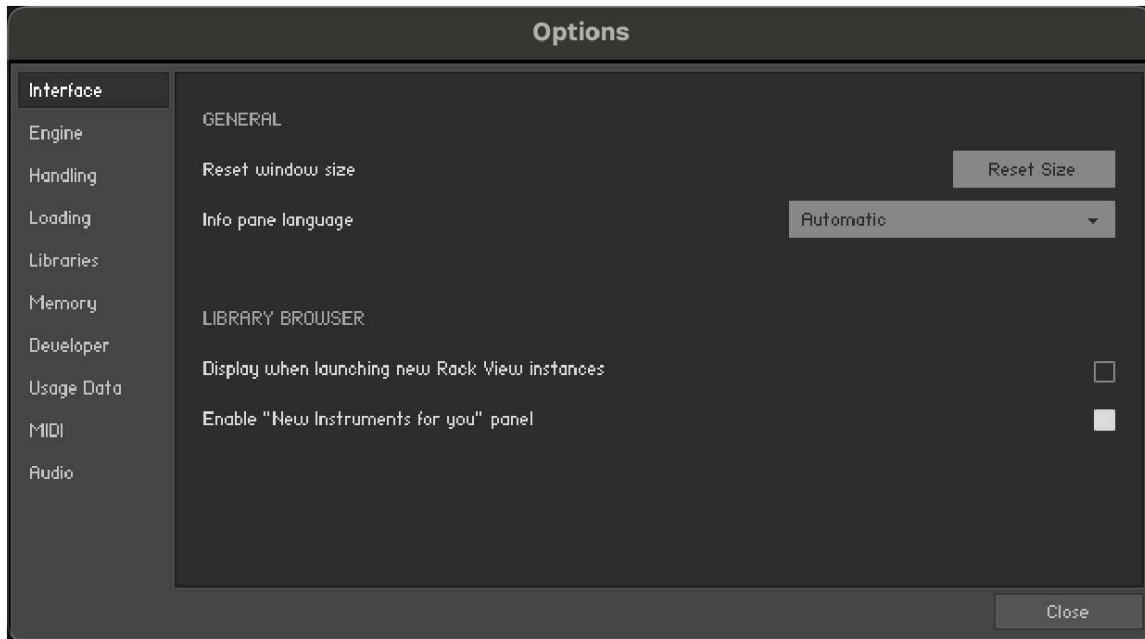

## Interface

The Interface tab contains options that change the look and behavior of Kontakt's user interface.

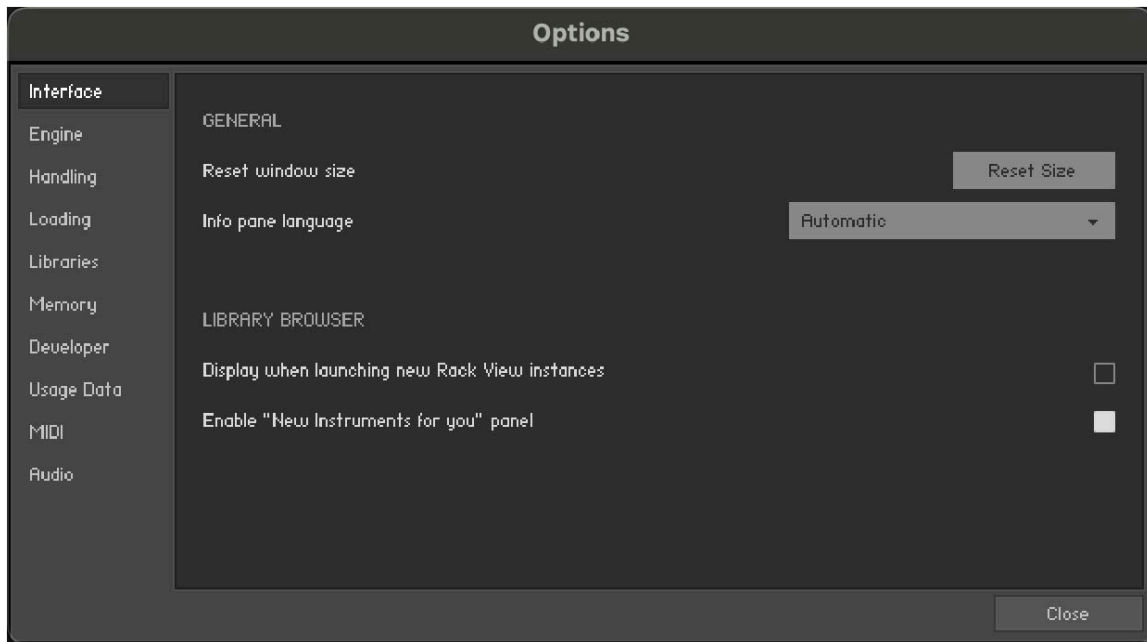

- **Reset window size:** If Kontakt's interface becomes too large and you can no longer access the resizing handle to the bottom right of the window, you can use this button to reset Kontakt's window size.
- **Info Pane Language:** Select a language from the drop-down list. If you select **Automatic**, Kontakt will use your operating system's language settings, unless it is unsupported, in which case Kontakt will use English.
- **Display when launching new Rack View instances:** When this setting is enabled, creating a new Rack View instance will launch with the Library Browser as first screen.
- **Enable "New Instruments for you" panel:** Hide the "New Instruments for you" panel by unsetting this box.

## Engine

The Engine tab contains options relating to the behavior of Kontakt's engine.

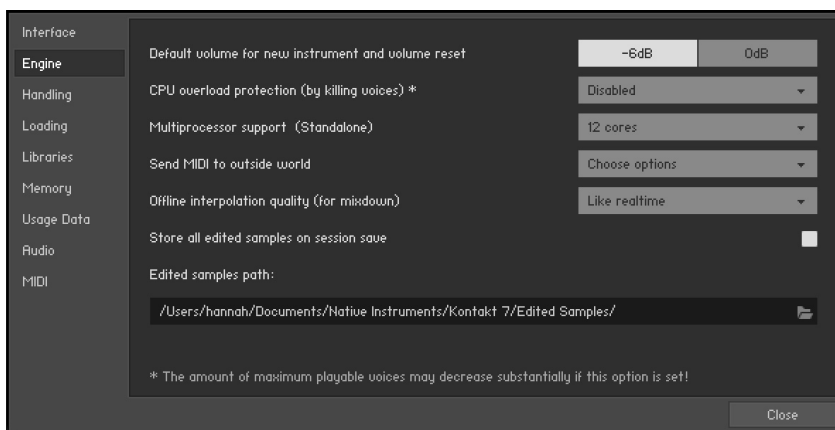



- **Default Volume for new instrument and volume reset:** This value will be used as a default output volume for new and imported Instruments. Also, it's the value to which the output volume slider will snap when you [Ctrl]/[Cmd] + click it.
- **CPU overload protection:** High voice counts can make the audio engine overload your CPU during operation; in such cases, the engine can choke and be rendered unusable until you restart it manually via the **Restart Engine** button in the **Engine** sub-tab of the **Monitor** tab in the Side pane. This scenario can be avoided with the overload protection mechanism, which allows Kontakt to kill voices when the CPU load gets critical. The **Relaxed**, **Medium**, and **Strict** settings affect how cautious Kontakt will be about this. **Relaxed** will not start killing voices until the CPU is very close to overloading, and thus will give you the highest voice count while still providing some protection against overloading; if the CPU load is still too high, try one of the stricter settings.
- **Multiprocessor support:** Kontakt can make use of multiple CPUs or multi-core processors. To switch multi-processor support on and off and to set the number of processors / cores you want to use for Kontakt, select the corresponding entry from the Multiprocessor support menu. Multi-processor settings are saved independently for a) the stand-alone and b) all plug-in versions. On multi-processor or multi-core systems, many factors influence the system's behavior. When running Kontakt as a plug-in, multi-processor mode can sometimes cause crackles and drop-outs. Whether or not these noises occur during playback strongly depends on your individual software and hardware setup. Therefore, the only option is to test which multi-processor setting works best for you when using the Kontakt plug-in. Note that multi-processor support is deactivated for the Kontakt plug-in per default (**off** entry in the Multiprocessor Support menu).  
For stand-alone usage, we generally recommend turning multi-processor support on. Use the above setting in the **Engine** tab of the **Options** dialog to enable multi-processor support according to the number of processors or cores installed.
- **Send MIDI to outside world:** This drop-down menu allows you to choose which classes of MIDI events will be sent to Kontakt's MIDI output port. Click a menu entry to toggle between on (indicated with a small diamond next to the entry) and off state. The available event classes are:
  - **GUI keyboard:** MIDI events that are generated when you click on Kontakt's virtual on-screen keyboard.
  - **script generated CC's:** MIDI controller events that originate from running Scripts.
  - **script generated notes:** Note-on and note-off events that originate from running Scripts.
  - **incoming CC's:** This will mirror incoming MIDI controller events at the MIDI output.
  - **incoming notes:** Mirrors incoming MIDI note events at the MIDI output.
- **Offline Interpolation Quality:** This option allows you to specify an interpolation quality setting for offline bouncing and freezing that's different from the one specified in the Source Modules of your Instruments. For instance, you might want to keep your Source Modules set to **standard** in order to save CPU resources during arrangement, but switch to **perfect** for bounces to get the best possible quality during mixdown. The default setting is **like realtime**, which will use each Source Module's HQI setting during offline operation.

## Handling

The Handling tab contains options that relate to the way Kontakt handles external keyboards, MIDI, and Undo commands.

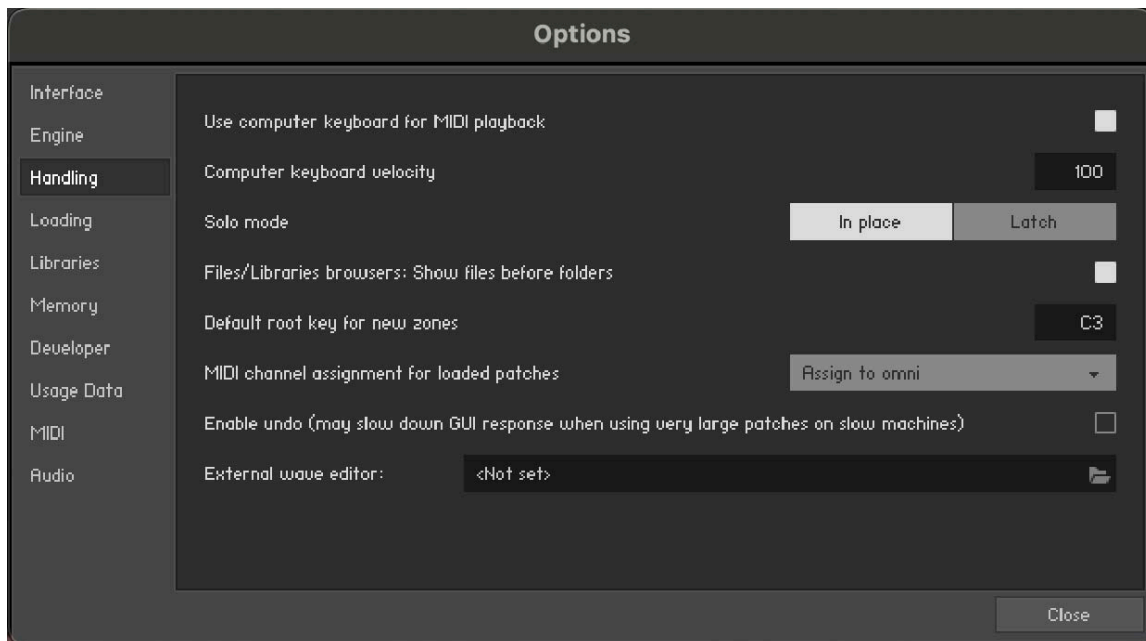

- **Use computer keyboard for MIDI playback:** Allows you to use your computer keyboard to trigger MIDI notes for the currently selected Instrument. When activated, the QWERTZ/QWERTY row of letters will play the middle octave.
- **Keyboard Velocity:** Adjusts the velocity of notes that are triggered via your computer keyboard.
- **Solo Mode:** Determines what Kontakt will do when you attempt to activate the Solo button on more than one Instrument. **In Place** will only allow one solo Instrument at any time, so any other one will be muted; **Latch** will let you switch more than one Instrument into solo mode.
- **Files/Libraries browser: Show files before folders:** Determines the order in which files and folders will be listed in the lower section of the Side pane.
- **Default root-key for new zones:** Specifies the root key for new Zones, if they are created from Samples with no embedded pitch information. The Zones will be generated with the root key specified here.
- **MIDI channel assignment for loaded patches:** Opens a drop-down menu that allows you to switch between two different modes that determine the way in which Kontakt will assign MIDI channels to newly added Instruments:
  - **Assign 1st Free** assigns the first available MIDI channel.
  - **Assign to Omni** is the default and will always assign loaded Instruments to **Omni**, thus making them respond to all input ports.
  - **Keep Channels from K1.x Patches** is an additional toggle option that allows you to specify whether Kontakt should use the MIDI channel embedded in Kontakt 1 patches. Later versions do not save MIDI assignments in Instrument files, only in Multi files.
- **Enable undo:** Enables the ability to undo actions, when the checkbox is selected. However, this can be quite resource intensive, especially with larger instruments, so by default this setting is unselected.
- **External wave editor:** Allows you to specify your own preferred sample editor. When you click the **Ext. Editor** button in the Wave Editor, Kontakt will start the specified editor with the current sample, and automatically pick up the changes when you save the Sample within that editor.

## Loading

The Loading tab contains options related to loading samples and Kontakt files.

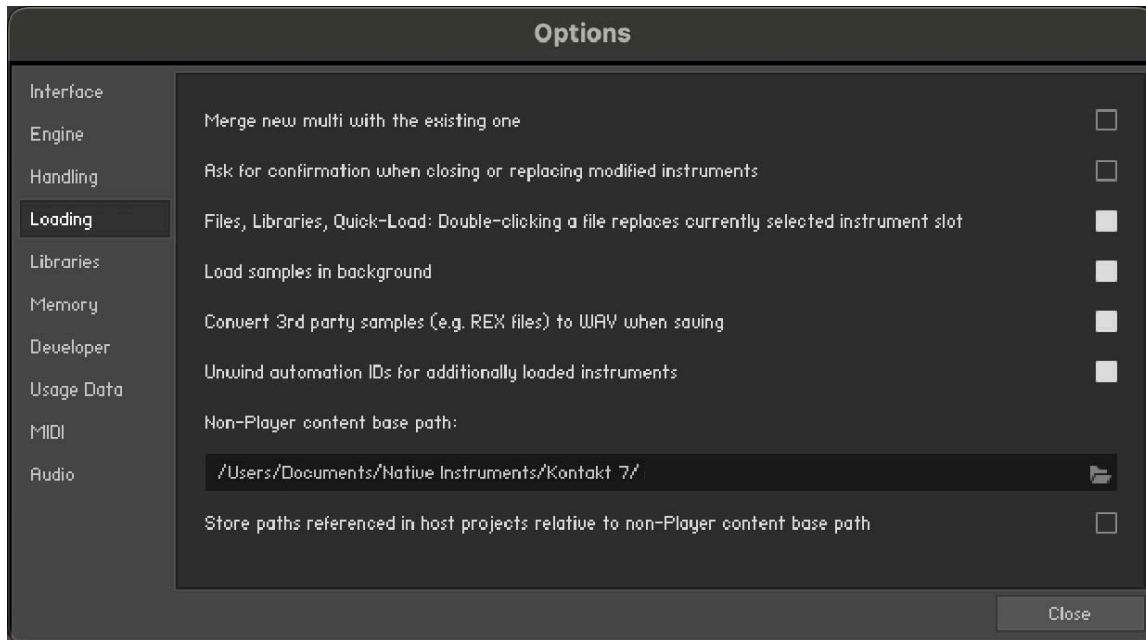

- **Merge new Multi with the existing one:** Enables a new Multi to be merged with the current Multi when loaded. If unselected, the current Multi will be discarded when a new Multi is loaded. Kontakt will not make a check and the current Multi will be replaced instantly.
- **Ask for confirmation when closing or replacing modified instruments:** Enables a confirmation dialog that pops up when closing or replacing a modified instrument. This is turned off by default.
- **Files, Libraries, Quick-Load: Double-clicking a file replaces currently selected instrument slot:** When enabled, loading any file or library by double clicking will replace the currently loaded file or instrument in the selected instrument slot. When disabled, files or instruments loaded this way will automatically create a new instrument slot.
- **Load samples in background:** Enables Kontakt to load instruments created in Kontakt 4.1 or later in the background. This feature is useful for instruments that use a large amount of samples and take a long time to load. With background loading active, Kontakt will display the instrument's interface and become playable as soon as possible. Certain keys may not sound immediately if the samples have yet to be loaded into memory.
- **Convert 3rd party samples to WAV when saving:** Enables Kontakt to save REX Samples used by third-party Instruments in WAV format. When unselected they will be saved in their native format.
- **Unwind automation IDs for additionally loaded patches:** Enables Kontakt to re-assign automation IDs of newly loaded Instruments if there is already an Instrument in your Multi that uses the same IDs. As an example, if you would like to add an Instrument twice to your Multi, which uses automation IDs 0 through 9; if this option is activated, Kontakt will change the assigned IDs of the second Instrument to 10-19 on load, provided that these IDs have not been used by other Instruments in your Multi yet.
- **Non-Player content base path:** Allows you to specify a base path for your Non-Player content. The option to store referenced paths relative to the base path is provided in the checkbox below. An option to use the path on Save is available and deactivated by default.

- **Store paths referenced in host projects relative to Non-Player content base path:** Determines if referenced paths are stored relative to the base path, or as subpaths. When selected, this option minimizes the occurrence of missing content when using Kontakt as a plug-in in a host DAW. When a host project is saved, Non-Player content will be able to resolve without the Missing Content dialog, if the libraries are located on the computer's path as defined in the base path field.

## Libraries

The Libraries dialog allows you to define which of your libraries appear in the Libraries tab of the Side pane. For more information, refer to [Side Pane \(Classic view\)](#).

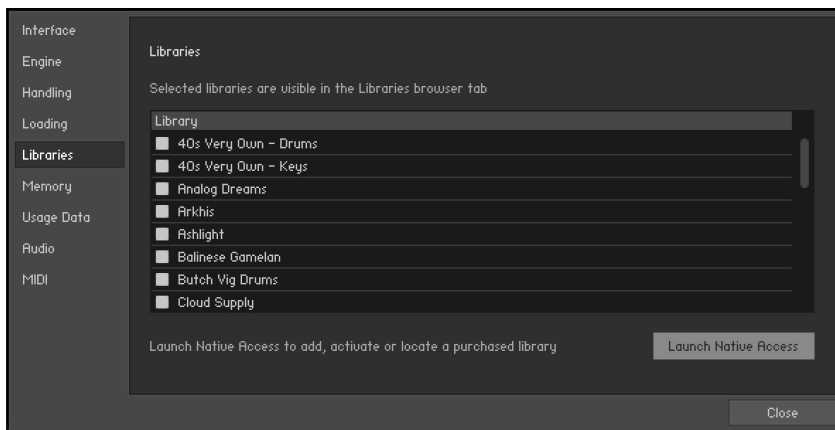

- **Hide Library:** Uncheck the entry in the list to hide a library from the Libraries tab of the Side pane without uninstalling it from your computer,
- **Show Library:** Check an entry in the list to show a library in the Libraries tab of the Side pane.



You can also open NATIVE ACCESS from the Libraries tab by clicking on the **Launch Native Access** button. For more information, visit [Native Access](#).

## Memory

On the **Memory** tab, you can optimize Kontakt's memory usage settings for your specific computer configuration.

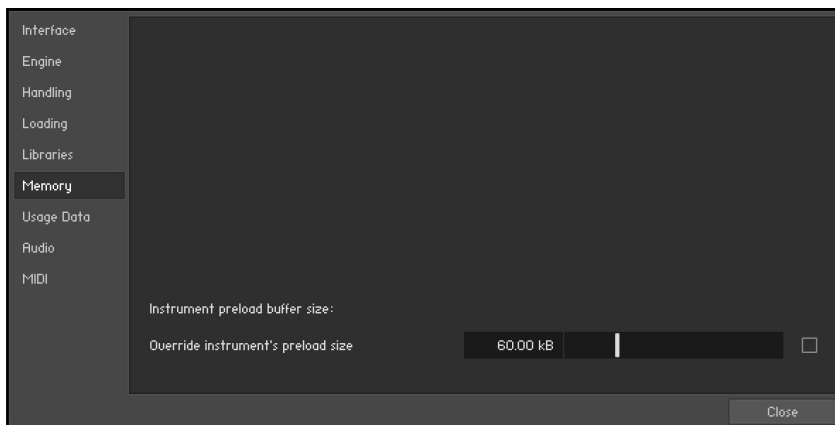

- **Override Instrument's preload size:** If activated, Kontakt will ignore the preload buffer size that's embedded in Instrument files since Kontakt 2, and use the specified buffer size instead. We recommend leaving the preload buffer size on default value. Memory improvements might be possible by moving the slider to the lowest setting possible without experiencing playback errors.

## Kontakt Memory Server options (macOS only)

**i** Using KMS is only recommended when working with very large numbers of samples which require more physical memory than one Kontakt instance can access. Do not enable Kontakt Memory Server if it is not absolutely necessary.

In order to use KMS on your computer, Mac OS X needs to be installed, and at least 4 GB of physical RAM must be available. Using KMS also requires administrator privileges, so make sure you are logged in as an administrator. Kontakt will detect the Mac OS X version and the amount of RAM present on your computer automatically. Subsequently, it will display an option to enable advanced memory access.

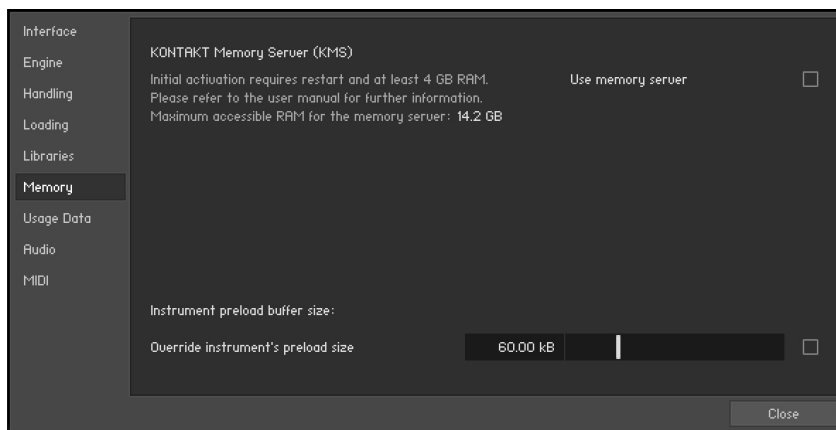

The Memory tab on OS X

After activating KMS you need to restart Kontakt for the changes to take effect.

Kontakt will automatically set the size of accessible RAM to a value suitable for most cases. You can find the amount of determined accessible RAM in the KMS Options dialog.

Kontakt Memory Server is a separate application running in background. Kontakt no longer loads samples itself as long as the KMS option is activated. All running Kontakt instances share the Kontakt Memory Server and can access the samples loaded. The Kontakt Memory Server will boot automatically as soon as you start a Kontakt instance.

The KMS utility appears in the Mac OS X system bar, so you can monitor the amount of RAM used by the server process. CPU and RAM requirements of KMS utility itself are negligible. Note that there is no option to shut down the KMS utility in Manual mode.

## Memory Server modes

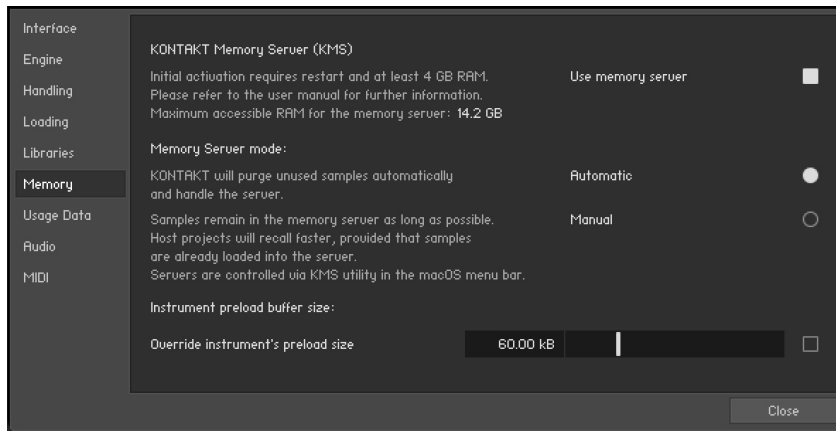

The Memory tab with Memory Server mode options

- **Automatic:** In Automatic mode the KMS will keep all samples currently used by Kontakt instances stored. If an Instrument is removed from Kontakt's rack, samples that are no longer needed will be also removed from the Memory Server's sample pool. The KMS will automatically shut down when all Kontakt instances are closed.
- **Manual:** In Manual mode the Kontakt Memory Server does not remove samples from the server when an instrument is removed from Kontakt's rack or when all Kontakt instances are closed. All samples stay in the memory as long as it is running. This can be helpful, e.g. when re-opening a project in your host sequencer which is using Kontakt as plug-in and when working with extensive templates of numerous instruments. Loading times are significantly shorter, since the samples are already stored in RAM and do not need to be loaded again.

## Managing the Kontakt Memory Server

The Kontakt Memory Server is managed via the KMS utility, which allows you to manually purge unused samples if you want to free memory. If you are running out of memory when loading additional Instruments, the server will automatically start to purge samples that are not referenced by any loaded Instrument.

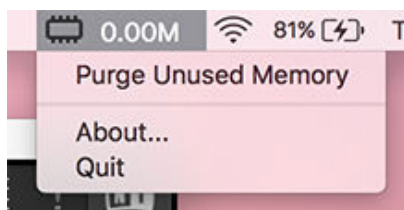

The KMS Utility in the Mac OS X system menu bar

## Developer

The Developer Tab includes a toggle for enabling development features. This allows you to use the Kontakt Lua API to modify files on your system via Lua scripts. For more information refer to the [Lua API reference manual](#).

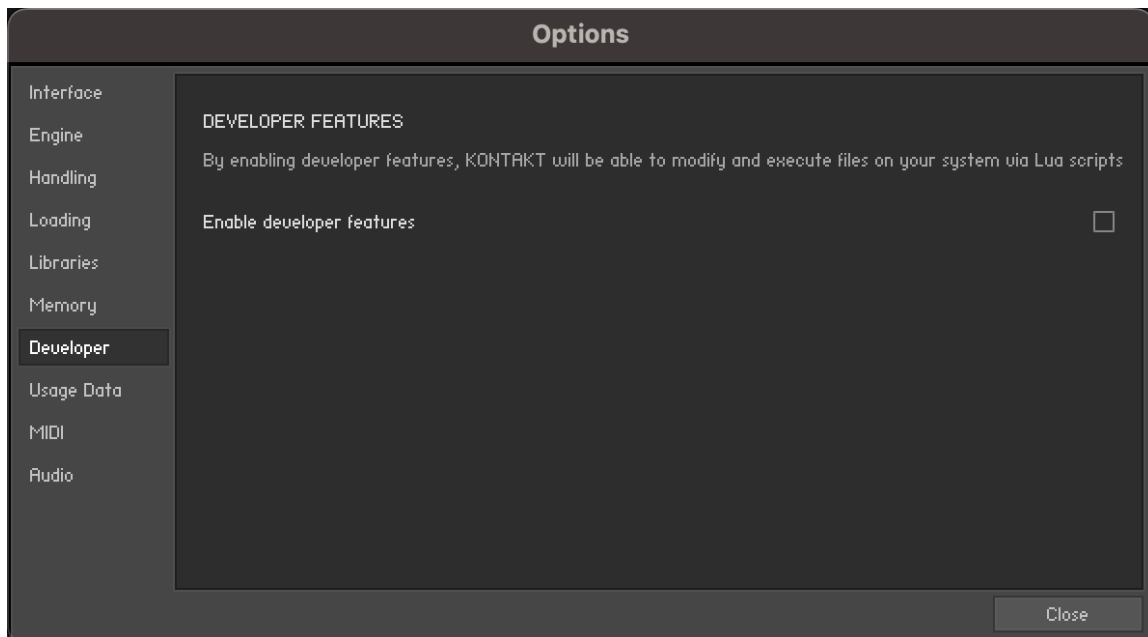

## Usage data

Kontakt collects data regarding your usage of the software in order to better inform future updates. Sending this data to Native Instruments will help make future versions of Kontakt better, but the choice of whether or not you want to share this information with Native Instruments is yours.

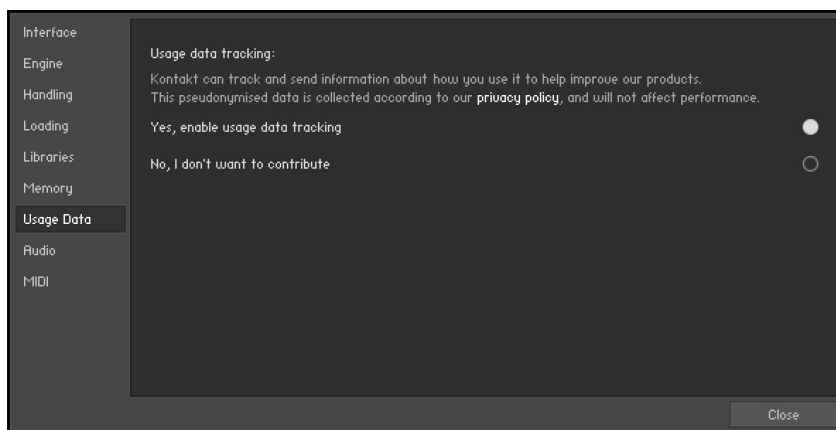

- **Yes, enable usage data tracking:** Selects the option to track and send usage data.
- **No, I don't want to contribute:** Selects the option to turn off data tracking.

 Refer to our [Privacy Policy](#) for more information on Usage Data Tracking.

## Audio

The contents of the Audio Tab are documented here: [Audio configuration](#).

## MIDI

The contents of the MIDI tab are documented here: [MIDI configuration](#)



# 16. File formats

The following file formats are supported by Kontakt:

## Kontakt file formats

NKI	Kontakt Instrument
NKM	Kontakt Multi
NKB	Kontakt Instrument Bank
NKP	Kontakt Preset
NKR	Kontakt Resource File
NCW	Kontakt Lossless Compression Audio File
NKX	Kontakt Monolith
NKC	Kontakt Cache File
NKS	Kontakt Snapshot File
N	
NKL	Kontakt Leap Kit

## Audio file formats

Software format	File extension
<b>ACID</b>	
Acidized Wave	.wav
<b>AIFF</b>	
mono / stereo	.aiff / .aif
multichannel	.aiff / .aif
<b>APPLE LOOPS</b>	
Apple Loop	.aiff / .aif
<b>Battery</b>	
Battery 1	.kit
Battery 2	.kt2
Battery 3 Kits	.kt3
Battery 3 Cells	.cl3
<b>Kontakt</b>	
lossless compressed	.ncw

Software format	File extension
<b>RECYCLE</b>	
REX 1	.rex
REX 2	.rx2
<b>WAV</b>	
mono / stereo	.wav
multichannel	.wav

# 17. Keyboard shortcuts

On OS X computers, use the [Cmd] (Command) key instead of the [Ctrl] (Control) key.

## Global

Shortcut	Function
[Ctrl] + [O]	Open Instrument
[Ctrl] + [S]	Save
[Shift] + [Ctrl] + [S]	Save As
[Ctrl] + [C]	Copy
[Ctrl] + [V]	Paste
[Ctrl] + [X]	Cut
[Ctrl] + [A]	Select All
[Alt] + [F4] (Windows) / [Cmd] + [Q] (Mac)	Quit
Delete / Backspace	Delete
[F9] (Windows) / [Ctrl] + [I] (Mac)	Info Pane
[F10]	Minimize view
[F12]	Options

## Side pane (Classic view)

Shortcut	Function
Alphanumeric Keys	Jump to file by name

## Instrument Edit mode

Shortcut	Function
Alphanumeric Keys	Play Instrument
[Ctrl] + [Z]	Undo
[Ctrl] + [Y]	Redo
[^] or [~]	Modulation Quick-Jump
[Esc]	Exit Instrument Edit mode

## Group Editor

Shortcut	Function
[Ctrl] + [D]	Duplicate Group

## Mapping Editor

Shortcut	Function
[Ctrl] + LMB	Cycle through overlapping Zones (inside Zones); Set Zone crossfades (on Zone edges)
[Shift] + LMB	Multiple selection; expand or collapse all Groups (in list view)
[Shift] + Cursor Keys	Add adjacent Zones to selection
[Ctrl] + Cursor Left / Right	Move key range of selected Zone(s) by one note
[Shift] + [Ctrl] + Cursor Left / Right	Adjust upper key limit of selected Zone(s) by one note
[Ctrl] + Cursor Up / Down	Move velocity range of selected Zone(s) by two steps
[Shift] + [Ctrl] + Cursor Up / Down	Adjust upper velocity limit of selected Zone(s) by two steps
[Shift] + LMB (Click + Drag)	Rubber band selection without moving Zones
[Alt] + LMB (Click + Drag)	Rubber band zooming
[+] (Number Pad)	Zoom in
[-] (Number Pad)	Zoom out
[Ctrl] + [T]	Auto-map selected Zone(s)
[Ctrl] + [E]	Auto-spread Zone ranges
[Ctrl] + [R]	Resolve key range overlaps
[Shift] + [Ctrl] + [R]	Resolve velocity range overlaps
[Ctrl] + [D]	Duplicate Zone
[Shift] + [Ctrl] + [E]	Auto-spread velocity ranges

## Wave Editor

Shortcut	Function
[Alt] + LMB (Click and Drag)	Rubber band zooming

# 18. Version history

## Kontakt 7.8

The following features have been added or improved in Kontakt 7.8:

- **ADDED:** New effects: EP Preamps, Fuzz, Big Fuzz, Stereo Tune
- **ADDED:** Option for double click Preset loading behavior ("Loading → Files, Libraries, Quick-Load: Double-clicking a file replaces currently selected instrument slot")
- **IMPROVED:** Loading speed when switching between snapshots of an actively loaded Instrument, when initiated from Library Browser
- **IMPROVED:** Increased the font size in Instrument Navigator
- **IMPROVED:** Instrument focus indicator (orange strip on the left of instrument header) is now only visible in Rack View
- **IMPROVED:** Use the resizer from Library Browser all across Kontakt
- **IMPROVED:** Kontakt now supports "Open with..." OS behaviors with samples, creating an instrument that has the specified sample mapped
- **FIXED:** Crash when Kontrol mk3 Hardware Connection Service not installed on macOS
- **FIXED:** Crash when playing a note after changing the output configuration with an already loaded Preset
- **FIXED:** Replika delay in Diffusion mode would not output sound when note duration was shorter than delay time
- **FIXED:** Visual glitches when resizing Kontakt's window across multiple displays
- **FIXED:** Replika delay not recalling delay time values correctly when loading snapshots that switch to Tape, Analogue and Vintage styles
- **FIXED:** CPU overloads during tempo ramps when Replika delay is bypassed
- **REMOVED:** Several entries in Options, which are now permanently enabled
  - "Interface → Show mapping and keyswitches on virtual keyboard"
  - "Interface → Auto-refresh Files browser"
  - "Handling → Files browser: Double click audio file loads instrument"

## Kontakt 7.7

The following features have been added or improved in Kontakt 7.7:

- **ADDED:** Simplified application header for efficient access to key functions
  - File, Library, and View have dedicated text labels
  - Single View / Rack View toggle is now found in View menu
  - Options is now found in File menu
- **Added:** Text search enhancements to full-screen Browser, allowing searches across full or partial names of libraries, instruments, presets, tags, and more
- **Added:** Search results display additionally available libraries in "New Instruments for you" panel
- **Added:** Options → Interface → "Display fullscreen Browser when launching new Rack View" to display fullscreen Browser for new Kontakt instances in Rack View. The Browser is always shown in Single View

- **Added:** 50% zoom setting
- **IMPROVED:** Double-clicking a preset in Files tab, Libraries tab or Quick-Load will now replace the preset loaded in the currently selected slot, instead of adding it to the Rack
- **IMPROVED:** Access fullscreen Browser by clicking Kontakt logo in application header. The About Box is accessed via the NI logo
- **FIXED:** Intermittent CPU spikes on macOS (introduced in Kontakt 7.6.1)
- **FIXED:** Regression in KSP message logging performance when Developer Options are enabled, causing CPU spikes in certain libraries
- **FIXED:** RAM footprint no longer increases after prolonged use
- **FIXED:** Instrument focus strip in instrument header now updates when using previous / next instrument buttons within instrument edit mode
- **FIXED:** Correct visual state for Library button when instantiating Kontakt
- **REMOVED:** "Batch resave" and "Batch collect / Compress samples" options in File menu will not show in plugin mode anymore

## Kontakt 7.6

The following features have been added or improved in Kontakt 7.6:

- **ADDED:** Kontakt can now be used directly with Kontrol MK3 keyboards
- **CHANGED:** Options → Loading → "Ask for confirmation when loading or replacing modified instruments" is now set to off for all users
- **CHANGED:** Options → Handling → "MIDI channel assignment for loaded patches" option is now set to "Assign to omni" for all users
- **CHANGED:** Options → Interface → both "Suppress drawing" options are now found in Mapping Editor's Edit → Display options
- **CHANGED:** It is now possible to focus on an empty instrument slot even in Single view
- **IMPROVED:** Per instance persistence of the Kontakt GUI state, which includes the layout (e.g. visibility of keyboard, info bar, side pane), zoom settings and full-screen browser
- **IMPROVED:** Loading an Instrument from full-screen browser now replaces the focused Instrument instead of adding it to the rack
- **IMPROVED:** Quick-Load menus in the top left of the instrument header now tells the user if Quick-Load is empty
- **ADDED:** 20 new Form shapes for the Wavetable source module
- **ADDED:** Vibrato/Chorus and Wow/Flutter factory presets from Guitar Rig 7
- **FIXED:** Kontakt would not respect offline rendering mode flag sent from host with the VST3 target
- **FIXED:** S1200 and MP60 sampler modes did not work
- **FIXED:** Typing a value for the Rate parameter of Vibrato/Chorus did not work correctly
- **ADDED KSP:** NKS2 parameters and navigation can be defined with KSP commands
- **ADDED KSP:** New control parameter, `$CONTROL_PAR_TYPE`, which returns the type of UI widget belonging to a specific UI ID
- **ADDED KSP:** New control parameter, `$CONTROL_PAR_CUSTOM_ID`, which allows assigning a custom value to each UI widget
- **ADDED KSP:** New internal constant, `$NI_UI_ID`, which returns the UI ID of the widget that executed the UI callback

- **ADDED KSP:** `$EVENT_PAR_MIDI_CHANNEL` can now be set for events in instrument scripts
- **ADDED KSP:** Engine parameter for Raum Predelay tempo sync (`$ENGINE_PAR_RAUM_PREDELAY_UNIT`)
- **FIXED KSP:** Twin Delay Predelay tempo sync, Cross and Width engine parameters did not work correctly
- **FIXED KSP:** `$EVENT_PAR_MOD_VALUE_(EX_)` ID getter now works properly when there is an active voice attached to the specified event ID
- **FIXED KSP:** Incorrect wording in script warning for `get_group_idx()` command

## Kontakt 7.6.1

The following has been fixed or changed in Kontakt 7.6.1

- **IMPROVED:** "Version too old" dialog now refers to the exact Kontakt version required to open a preset
- **IMPROVED:** Orange instrument focus rectangle is now reduced to a strip on the left side of the instrument header
- **IMPROVED:** Mapping Editor display option adjustments are now stored immediately upon change
- **FIXED:** Crash when attempting to save an instrument that attempts to MIDI learn or host automate above 512th instance of a KSP widget
- **FIXED:** Crash when instantiating a send effect when the output channel is set to Mono
- **FIXED:** Crash on quickly swapping presets while notes are playing under certain condition
- **FIXED:** Rare seemingly random voice dropouts in DFD mode when using loop crossfades
- **FIXED:** From script modulator could cause Kontakt to hang under certain conditions
- **FIXED:** Virtual keyboard was not shown by default when instantiating Kontakt on fresh install
- **FIXED:** Kontakt did not instantiate in single mode on fresh install
- **FIXED:** `set_controller()` did not work in `persistence_changed` callback when instrument is set to Omni
- **FIXED KSP:** `$ENGINE_PAR_RINGMOD_LFO_WAVE` getter always returned 0
- **FIXED KSP:** DFD preload buffer issue when using zone parameter setters on purged zones

## Kontakt 7.5

The following features have been added or improved in Kontakt 7.5:

- **CHANGED:** Minimum supported macOS version is now 11.0

### Kontakt Engine Improvements

- **ADDED:** Seven new effects: Bite, Dirt, Freak, Raum, Twin Delay, Vibrato/Chorus, Wow/Flutter
- **IMPROVED:** Context menus now follow zoom scaling settings
- **IMPROVED:** Rendering quality of raster images in Native UI based instruments
- **IMPROVED:** MIDI files dragged out of Kontakt don't have the copyright message anymore
- **IMPROVED:** NKG files are now visible in Files browser and also loadable or importable via double-click or drag and drop
- **IMPROVED:** Maximum number of host automation slots increased to 2048

- **FIXED:** Legato button did not work in any Tone/Time Machine mode except TMPro
- **FIXED:** Clicking on virtual keyboard when Kontakt was in Single view did not respect the MIDI channel setting of multiple loaded instruments

## Browser Improvements

- **ADDED:** A button for loading the first preset directly from the instrument tile
- **ADDED:** Filtering by brand
- **ADDED:** Filtering by sub-bank
- **ADDED:** User-authored presets can now have sound and character type metadata edited in bulk via multi-selection
- **ADDED:** Warning dialog with a list of files that failed to import
- **FIXED:** Scroll position is set to zero when the result list is resized
- **FIXED:** Resizing the window no longer resets the result list selection
- **FIXED:** Folders beginning with "-" can now be imported
- **FIXED:** Content type does not update with the focused module slot

## Instrument Building and Scripting Improvements

- **ADDED:** Kontakt Lua API, enabled through the new Developer panel in Options dialog
- **ADDED:** Various options for showing or hiding incoming, script generated and ignored events in Mapping Editor
- **ADDED:** Source module's playback mode can now be retrieved with `$ENGINE_PAR_SOURCE_MOD` getter
- **ADDED:** Option to snap sample start/end to zero crossings in Wave Editor
- **ADDED:** Option to copy sample end setting to all selected zones in Wave Editor
- **ADDED:** "continue" statement is now available in KSP
- **ADDED:** Real arrays can now be stored to and loaded from NKA files
- **ADDED:** Selection state of a zone can now be queried with `$ZONE_PAR_SELECTED` zone parameter, and a list of all currently selected zones can be retrieved with `get_sel_zones_idx()` command
- **ADDED:** `set_map_editor_event_color()` KSP command, which allows changing color of script-generated events in Mapping Editor, individually per script slot
- **IMPROVED:** Snap to value or zero crossing options in Wave Editor are now retained per instrument, rather than per zone
- **IMPROVED:** Internal modulator and modulation target KSP information is now always shown if Developer Options checkbox is enabled
- **IMPROVED:** TMPro polyphony can now be set to 0 via KSP, in order to match the range of the related parameters in Instrument Options->Voice Handling dialog
- **IMPROVED:** Snapshot files (.NKSX) can now be loaded from the File->Load... dialog
- **IMPROVED:** Reorganized Mapping and Group Editor context menus
- **IMPROVED:** Reorganized effect selection context menu
- **FIXED:** Boolean "not" operator would not correctly invert a boolean expression that consisted of only literals or constants
- **FIXED:** Function call stack would collapse entirely if "exit" statement was used at the beginning of user defined functions, rather than only exiting the currently called function



## Kontakt 7.4

The following features have been added or improved in Kontakt 7.4:

- **ADDED:** Zoom scaling of Kontakt application UI
- **FIXED:** Snapshots couldn't be saved when Ring Modulator LFO Wave parameter was modified from KSP
- **FIXED:** Crash when selecting items from dropdown menus in Playbox
- **FIXED KSP:** Reset waitless while loop iteration counter on every while loop instead of once per callback and increased the amount of such iterations to 10 million

## Kontakt 7.3

The following features have been added or improved in Kontakt 7.3:

- **ADDED:** Option to snap sample start and end to zero crossing in Wave Editor.
- **IMPROVED:** Selecting one of the loop snapping modes in the Wave Editor is now global for the instrument instead of per zone.
- **IMPROVED:** Any change in Options dialog is now stored immediately after closing the dialog instead of after exiting Kontakt.
- **FIXED:** PsycheDelay and Ring Modulator Info Pane help texts were mostly missing.
- **IMPROVED:** KSP `in_range()` command now also works with real expressions.
- **IMPROVED:** KSP Added optional arguments to `sort()` command which allows sorting only a range of the array instead of the whole array.
- **FIXED:** KSP Script warning for `get_mod_idx()` and `get_target_idx()` commands now correctly refers to the names of those commands.

### Kontakt 7.3.1

The following bug has been fixed in Kontakt 7.3.1:

- **FIXED:** White noise burst in some cases when Spread parameter of Stereo Modeller was modulated.

### Kontakt 7.3.2

The following has been changed or added in Kontakt 7.3.2:

- **ADDED:** Link to online store for quick access to additional content.
- **CHANGED:** Update to in-app branding.

## Kontakt 7.2

The following features have been added or improved in Kontakt 7.2:

- **ADDED:** Bus amplifier section now includes phase invert and L/R swap controls.
- **ADDED:** Naming voice groups is now possible in Group Editor.
- **ADDED:** Stereo Modeller Pan parameter can now be modulated.
- **ADDED:** Lo-Fi Color parameter can now be modulated.
- **ADDED:** Lowpass and Highpass filters in Solid EQ.
- **ADDED:** Repack NKR button in Instrument Options dialog (only shows if the instrument has a resource container assigned).

- **ADDED:** Collection of new wavetables and single cycle waveforms.
- **ADDED:** Several new mod shaper presets.
- **IMPROVED:** Previous and next instrument buttons in Single View are now disabled if only one instrument is loaded.
- **IMPROVED:** Output section now correctly recalls effect slot settings saved in output section presets.
- **IMPROVED:** Show additional useful info about the instrument in Monitor > Groups and Monitor > Zones panes.
- **IMPROVED:** All remaining dropdown menus are replaced with HiDPI menus.
- **FIXED:** TMPPro Legato behavior was incorrect since Kontakt 7.1.3.
- **FIXED:** Kontakt would crash attempting to reveal a sample in the Mapping Editor with no sample selected.
- **FIXED:** Bass Pro would always process the signal in stereo even if Mono button was enabled.
- **FIXED:** Mismatch in sample rate during sample analysis for AET filter which caused incorrect frequency response for non-44.1k samples.
- **FIXED:** In certain cases the performance view would be incorrectly shifted in the rack.
- **FIXED:** In certain cases the performance view size would not be updated correctly.
- **FIXED:** Slice Trigger group start condition listed available slices in the Trigger Zone menu, instead of Slice Index menu.
- **FIXED:** Pitch Bend Down/Up Only mod shaper presets were affecting the tuning even when pitch bend controller was zeroed out.
- **FIXED:** Harmonize and Harmonize - Tonal multi scripts produced an extraneous note off event for the original note.
- **REMOVED:** Pop-out buttons for Mapping/Wave Editors in plugin versions.

## Kontakt 7.1

The following features have been added or improved in Kontakt 7.1:

- **ADDED:** Purge all instances when Kontakt 7 is running as a plug-in.
- **ADDED:** 6 pole state variable (SV) filters.
- **ADDED:** Tone Machine and Time Machine 1 Smooth parameter modulation.
- **ADDED:** Reveal sample location via Mapping Editor edit menu and Wave Editor command menu (cog).
- **IMPROVED:** Maximum number of host automation slots increased to 1024.
- **IMPROVED:** Flex envelope slope can now be modulated for the first 8 segments, and includes Loop and Oneshot parameters.
- **IMPROVED:** Online KSP documentation can be directly accessed through the help menu.
- **FIXED:** Right click to open Quick-Load not working.
- **FIXED:** DAW key commands intercepted by Kontakt when running as a plug-in.
- **FIXED:** Notes would auto repeat when holding a key when using QWERTY as virtual keyboard.
- **FIXED:** Temporarily black performance view when loading Kontakt Factory Library 2 instruments.
- **FIXED:** Plug-in window would not re-open after being closed in Renoise with Kontakt VST3.

- **FIXED:** Crash using Quick-Load with a large number of entries. Number of visible entries has been reduced to 5000 as a consequence.
- **FIXED:** Voices would hang with certain effects placed post amp.
- **FIXED:** Time Machine Pro Legato would get out of sync when playing loops.
- **FIXED:** Cabinet effect in Output section would cut off the sound.
- **FIXED:** Excessive smoothing on group Tune parameter in wavetable mode.
- **FIXED:** "Restore loops from samples" option in Wave Editor not working when using the same sample repeatedly.
- **FIXED:** Auto-mapping using the "Make group name" token did not work properly.
- **FIXED:** Pasting a group without samples would paste with samples, and pasting groups with samples was not refreshing the Mapping Editor.
- **FIXED:** Loops 2-8 were not working in MP60, S1200 and TMPro modes.
- **ADDED:** Presets list now displays and sorts Instruments, Multis and Snapshots by their file type.
- **ADDED:** Reset Browser filter state.
- **ADDED:** Import multiple Custom Libraries in bulk.
- **ADDED:** Customize name of imported Custom Libraries (using the Alias field).
- **ADDED:** Error messages for failed Library import.
- **IMPROVED:** Tooltips display full text for Import Dialogue Folder path and Alias field, as well as Library tiles, in case when the text was truncated.
- **FIXED:** Resized components are now correctly displayed when the Preset list is dragged horizontally.

## Kontakt 7.0

The following features have been added and improved in Kontakt:

- **Factory Library:** The Factory Library has been redesigned and features seven new Collections of instruments, fresh sounds, effects, added functionality and a HiDPI interface. Refer to the [Kontakt Factory Library Manual](#).
- **Library Browser:** New Library Browser with advance filtering and tagging options. Refer to [Browser and presets](#).
- **Two Effects:** New PsycheDelay and Ring Modulator effects. Refer to [PsycheDelay](#) and [Ring Modulator](#).
- **HiDPI:** Kontakt is now HiDPI. To learn more, [visit our FAQ](#).
- **Improved Engine:** Updated time stretching algorithm.
- **Updated Side Pane:** The Database tab has been removed, its function replaced with the new [Library Browser](#). The Expert tab has been renamed to Monitor tab. Refer to [Monitor Tab](#).