

The following features are available in this PDF document.



Quick Keyword Search

Enter the keyword in the search box and hit the search button



Quick Jump between Chapters

Click the title of a specific chapter on the Contents to jump to it

*Reading software such as Adobe Reader is needed to support the functions above.



ZHIYUN MOLUS X60 COB Light

User Guide

Contents

<input type="checkbox"/> Brief Introduction	
Brief Introduction	1
<input type="checkbox"/> Product List	
Product List	3
<input type="checkbox"/> Get to Know ZHIYUN MOLUS X60	
Get to Know ZHIYUN MOLUS X60	5
<input type="checkbox"/> Power Supply	
Power Supply	6
<input type="checkbox"/> Installing and Removing ZHIYUN Mini Reflector (hereinafter referred to as "reflector")	
Installing the Reflector	8
Removing the Reflector	8
<input type="checkbox"/> Installing the Tripod	
<input type="checkbox"/> Installing and Removing ZHIYUN Mini Softbox (hereinafter referred to as "softbox")	
Installing the Softbox	10
Removing the Softbox	11
<input type="checkbox"/> Installing and Removing ZHIYUN diffusion dome (hereinafter referred to as "dome diffusion")	
Installing diffusion dome	12
Removing diffusion dome	12
<input type="checkbox"/> How to Use ZHIYUN MOLUS X60	
Buttons and Dials	13
Operation Instruction	14
Power-on Settings	16









<input type="checkbox"/> Firmware Upgrade	
<input type="checkbox"/> Product Specifications	
<input type="checkbox"/> Disclaimer and Warnings	
Reading Tips	21
Safe Operation Instructions	21
<input type="checkbox"/> Warranty Card	
Warranty Period	22
Warranty Exclusions	22
Warranty Claim Procedure	22
<input type="checkbox"/> Contact Card	

Brief Introduction

ZHIYUN MOLUS X60 is a high-power, portable, dual-color temperature fill light. It boasts a stylish appearance and compact size, and supports color temperature adjustment functions. It also features a variety of creative light effects, making professional light effects easily achievable. The product has the following highlights:

1. Lightweight, portable and easy to use.
2. Features adjustable brightness/color temperature, suitable for a wide range of applications.
3. Features high color rendering performance for accurately restoring the original color of objects.
4. Equipped with DynaVort Cooling System™ for excellent heat dissipation.
5. Supports music mode for easily creating a music scene atmosphere.
6. Supports Bluetooth mesh networking, APP remote dimming, for more efficient light control.
7. Offers multiple power supply methods, ensuring worry-free battery life.
8. Comes with a wealth of modifiers for precise light control.

WARNING

-  This product is not waterproof. Prevent contact with any kind of liquid with the ZHIYUN MOLUS X60. Never use the product in the rain or a humid environment.
-  If water accidentally enters the device when using, please stop using it immediately and contact the company or authorized maintenance personnel for maintenance, and continue to use it only when the maintenance is finished.
-  Do not expose this product to corrosive chemicals, inflammable and explosive materials.
-  Please connect the device to a grounded outlet before using.
-  Do not touch the heating part when the product is working to avoid getting burned.
-  Do not wrap or block the fans to avoid cooling effect damage.
-  Do not turn the product directly to the eyes to avoid eyesight damage.
-  Do not expose this product to an environment above 40°C .

⚠ Battery safety precautions:

- ① It is strictly prohibited to use batteries that are not provided by ZHIYUN.
If you need to replace the battery, please contact ZHIYUN or designated agents. ZHIYUN will not be responsible for any battery accidents or equipment malfunctions caused by using batteries that are not officially provided by ZHIYUN.
- ② If the battery bulges, leaks, or has other abnormalities, please stop using it immediately and contact ZHIYUN customer service or designated agents for further processing.
- ③ Do not completely discharge the battery and store it for a long time to prevent the battery from entering an over-discharged state and causing damage to the battery cell, which may make it impossible to recover and reuse.

BE CAREFUL

1. This product is a high-precision control device. Damage may be caused to the product if dropped or subject to external force, and this may result in malfunction.
2. Please keep your hands dry while using the product and use soft dry cloth for cleaning.
3. Keep this product out of the reach of children.
4. When not using this product, please disconnect the external power supply.
5. Do not place any other items on top of this product to avoid damage to this product.
6. Protect the product from dust and sand during use.
7. Before storing this product, please make sure it is completely cooled and store it in a dry and ventilated place.
8. Do not disassemble this product on your own. In the event of malfunctions, it should be repaired by ZHIYUN or authorized maintenance personnel.

Product List

Before using this product, please check carefully that all the following items are included in the product package. In case that any item is found missing, please contact ZHIYUN or your local selling agent.



Fill Light x1



DC Power Adapter x1

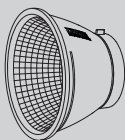

ZHIYUN Mini Reflector x1



ZHIYUN Silicone Diffusion Dome x1

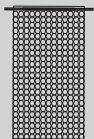

Power Adapter Organizer Bag x1

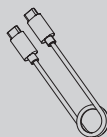

USB-C Cable x1*



ZHIYUN MOLUS Grip Battery x1*

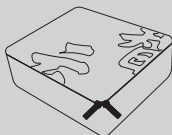

Storage Bag x1*

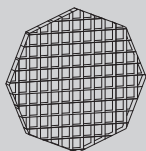

Grid x1**



ZHIYUN Mini Softbox x1**

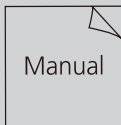

Quick Start Guide x1

Items marked “*” are included in the ZHIYUN MOLUS X60 COMBO and PRO package.

Items marked “**” are included in the ZHIYUN MOLUS X60 PRO package.

The ZHIYUN MOLUS X60 PRO package includes two ZHIYUN MOLUS grip batteries.

Get to Know ZHIYUN MOLUS X60

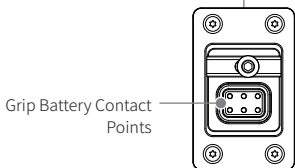
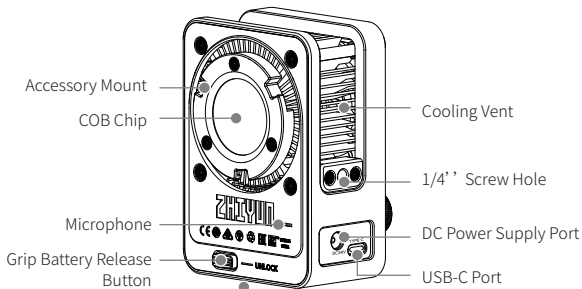
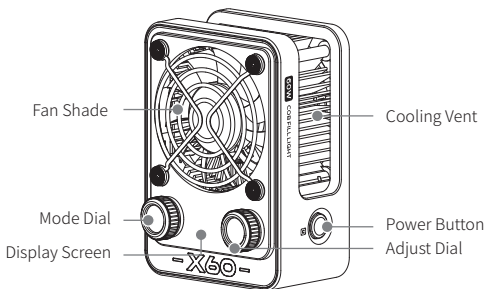

Power Supply

The battery is not included inside the device. For the ZHIYUN MOLUS X60 to work properly, please power the device using one of the following methods:

① **Power via USB adapter:** Use the USB Type-C charging cable to connect the USB adapter (not provided) and the USB-C power supply port of ZHIYUN MOLUS X60. Plug the adapter into the AC socket to power ZHIYUN MOLUS X60. It is recommended to use an adapter equal to or larger than 100W and supports PD fast charging protocol. The power will be displayed on the screen in real-time. When the input power is insufficient, it is unable to adjust the brightness of ZHIYUN MOLUS X60 to 100%.

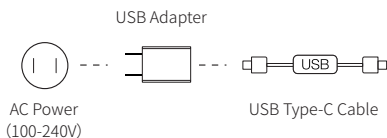

② **Power via DC power adapter:** Connect the DC power adapter to the DC power supply port and an AC socket to power ZHIYUN MOLUS X60.

AC Power (100-240V)

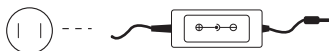

💡 You can use a power adapter organizer bag to organize the DC power adapter and hang at the proper location to avoid being stepped on.

- ③ **Power via ZHIYUN MOLUS Grip Battery:** Remove the silicone case at the ZHIYUN MOLUS grip battery contact points, and install the ZHIYUN MOLUS grip battery to the ZHIYUN MOLUS X60 as shown in the image to power ZHIYUN MOLUS X60.

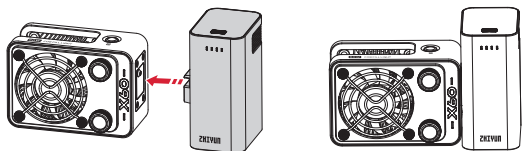

- 💡 To remove the ZHIYUN MOLUS grip battery, press and hold the grip battery release button and remove the grip battery from the ZHIYUN MOLUS X60.

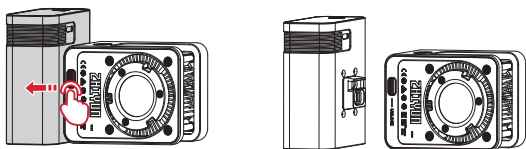

ZHIYUN MOLUS grip battery charging method: Use the USB Type-C charging cable to connect the USB adapter and the Type-C charge-discharge port of the grip battery. Plug the adapter into the AC socket to charge the grip battery. It is recommended to use an adapter that supports PD fast charging protocol.

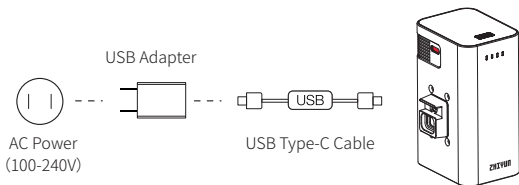

- 💡 Four solid battery level/charging indicator lights indicate the battery is fully charged.

Installing the Reflector

Align the reflector mount with the ZHIYUN MOLUS X60 accessory mount. Install the reflector to the ZHIYUN MOLUS X60 and rotate the reflector as shown in the image until you hear a click sound. The reflector is then installed.

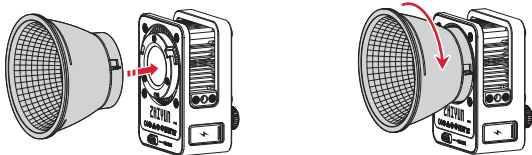

Removing the Reflector

Toggle the lock to another side ① and turn the reflector as shown in the image ②. Remove the reflector from the accessory mount ③.

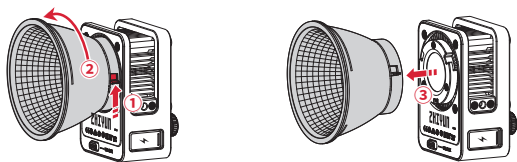

Installing the Tripod

Align the 1/4" screw of the tripod with the 1/4" threaded hole at the bottom of the ZHIYUN MOLUS X60. Drive the screw firmly to finish the installation.

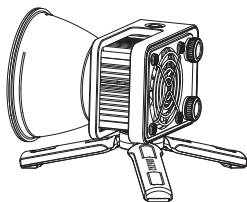
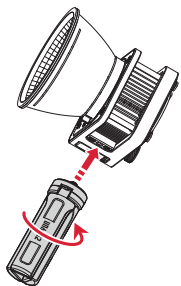

💡 Tripod is not provided.

Installing the Softbox

Align the softbox mount with the ZHIYUN MOLUS X60 accessory mount, install the softbox to the ZHIYUN MOLUS X60 ① and rotate the softbox as shown in the image until you hear a click sound ② . Loosen the softbox straps ③ , push the axis to the right as shown in the image until the softbox expands and clicks into the mount ④ . Expand the grid ⑤ and stick to the diffuser ⑥ .

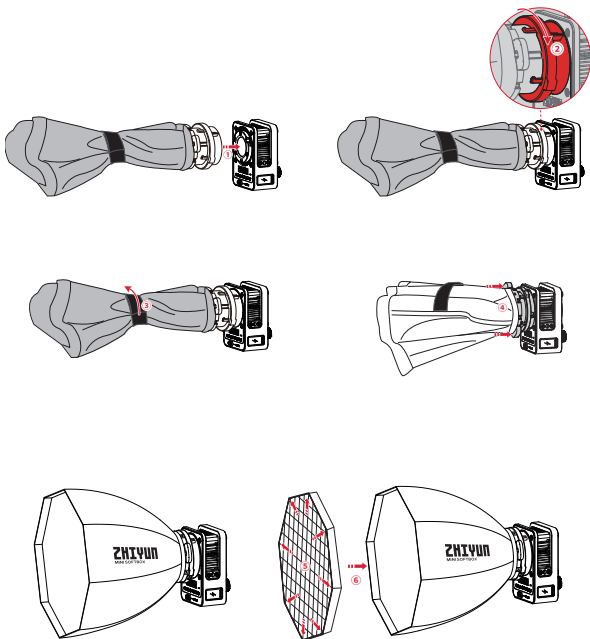

Removing the Softbox

Remove the grid from the softbox ① and rotate the softbox mount swivel as shown in the image ② . Toggle the lock to another side ③ while rotating the softbox as shown in the image ④ . Remove the softbox from the ZHIYUN MOLUS X60 accessory mount ⑤ . Pack the softbox and tie the straps.

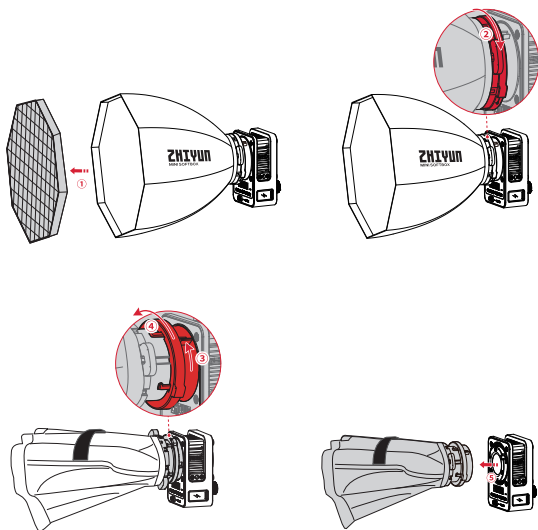

Installing Diffusion Dome

Install the reflector to ZHIYUN MOLUS X60. Expand the diffusion dome as shown in the image, and align the opening of the diffusion dome with the reflector. Engage the groove ring of the diffusion dome in the reflector.

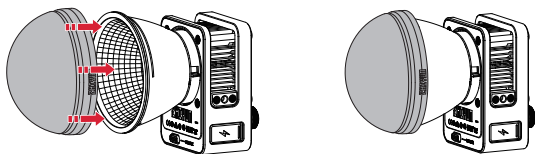

Removing Diffusion Dome

You can remove the diffusion dome from the reflector with your hand.

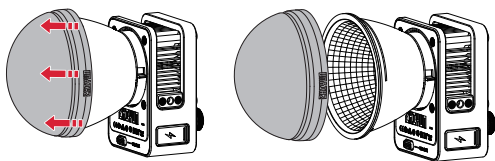

⚠ DO NOT stare at the chips when the device is operating.

⚠ The IP rating of the outer case is IP20.

Buttons and Dials

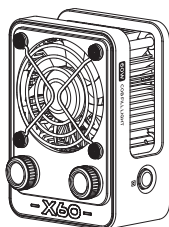

Power Button:

Long press the power button and turn the Adjust dial/
Mode dial Power on (grip battery powered).

Long press the power button:

Power on (USB/DC powered)/Power off

Triple press the power button: Reset Bluetooth



Mode Dial:

Single press: Switches modes

Double press: Switches to the previous mode.

Turn: Switches options (submenu).

Adjusts parameters (in CCT mode).



Adjust Dial:

Single press: Quickly adjusts the current parameter.
Confirm (submenu).

Turn: Adjusts the current parameter.

Operation Instruction

1. CCT Mode Settings

Single press Mode dial to switch to CCT mode. Single press or turn the Adjust dial to adjust brightness. Turn the Mode dial to adjust color temperature.

Brightness adjustment range: 0-100%

Color temperature adjustment range: 2700K-6500K.

CCT	PD60W
BRT:	100%
CCT:	5500k

2. FX Mode Settings

Single press Mode dial to switch to FX mode. Turn the Mode dial to switch to brightness/speed/color temperature options. Single press or turn the Adjust dial to adjust the value.

FX types: SOS, Paparazzi, Candlelight, Faulty Bulb, TV, Lightning, Strobe, Color Temperature Loop, Color Temperature Flash, Color Temperature Pulse,

FX	PD60W
FX:	SOS
DIM:	100%
SPD:	5 ▼

- ① The adjustable parameters vary under different light effects and the operation steps are similar. The “SOS” effect is used as an example to demonstrate the operation steps above.
- ② The parameter values in a single light effect are only effective for that light effect.

3. Music Mode Settings

Single press Mode dial to switch to Music mode. Single press or turn the Adjust dial to adjust brightness. Turn the Mode dial to adjust color temperature.

Brightness adjustment range: 0-100%

Color temperature adjustment range: 2700K-6500K.

Music	PD60W
BRT:	100%
CCT:	5500K

4. Menu Settings

Single press Mode dial to switch to Menu. Turn the Mode dial to switch to language/Bluetooth reset/power-on setting options. Turn the Adjust dial to adjust the chosen option. Finally, press the Adjust dial once to confirm.

MENU	PD60W
language:	English
BT Rst:	NO
Live:	off ▼

 Under the "MENU" option, you can also check the firmware version information for the ZHIYUN MOLUS X60.

Power-on Settings

In power-on settings, you can customize the way to power on the ZHIYUN MOLUS X60. The Live mode is turned off by default. Turn the Adjust dial to select to turn on/off the Live mode and press the Adjust dial once to confirm.

MENU	PD60W
language:	English
BT Rst:	NO
Live:	off ▼

- When the ZHIYUN MOLUS X60 is powered by a USB adapter/ZHIYUN MOLUS grip battery, the live mode will be disabled:
 - ZHIYUN MOLUS grip battery powered: Long press the power button and turn the Adjust dial or Mode dial to power on the light.
 - USB adapter powered: Long press the power button to power on.
 - When the ZHIYUN MOLUS X60 is powered by a DC power adapter:
 - When the Live mode is off: Long press the power button to power on the light.
 - When the Live mode is on: After directly unplugging the ZHIYUN MOLUS X60 from the power source, simply plug it back in and the light will turn on immediately with no button press required.
-  When the light is powered by a DC power adapter and the Live mode is on, if you use a long press at the power button to power off the ZHIYUN MOLUS X60, you need to also use a long press to power on the light when you plug the power source back in again.

You can use “Zhiyun Led Tools” or “ZY Vega” to perform the ZHIYUN MOLUS X60 firmware upgrade.

Method 1:

1. Visit the official website of ZHIYUN (www.zhiyun-tech.com), go to the ZHIYUN MOLUS X60 product page, click "Download", find the Zhiyun Led Tools and the firmware and download.
2. Unzip the firmware for the files with the ".ptz" file extension.
3. Connect the USB-C port of ZHIYUN MOLUS X60 to the USB port of the computer with the USB Type-C cable.
4. Open "Zhiyun Led Tools", click "Open", and click "Firmware Upgrade". Click "Browse" under "Path" to select the latest firmware downloaded (with the ".ptz" file extension), and click "Upgrade" at the bottom to upgrade firmware. ZHIYUN MOLUS X60 will automatically turn off when the upgrade is finished.

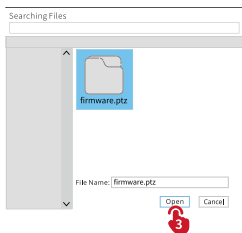
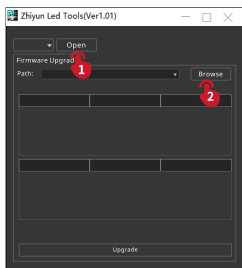
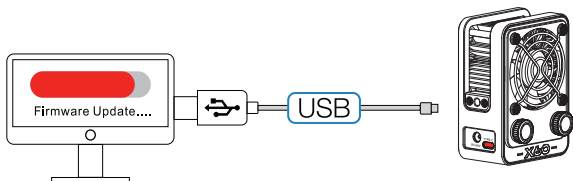

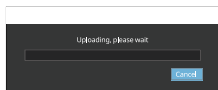
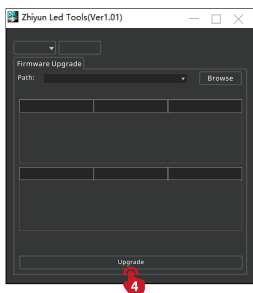

Method 2: The firmware of the ZHIYUN MOLUS X60 can be upgraded using the "ZY Vega" app. For more detailed instructions, please visit the ZHIYUN official website at www.zhiyun-tech.com and watch the related video tutorials for the ZHIYUN MOLUS X60.

- ① When using Method 1 for the upgrade, please wait until the screen displays that the upgrade is finished, then you can plug out the USB Type-C cable.
- ② Before upgrading the firmware, please ensure that the ZHIYUN MOLUS X60 has more than 50% power remaining. You can not exit the app interface or access in the background during the upgrading process. Pay attention to the prompts on the app.

Product Model: PLX105

Maximum Output Power	60W	
Brightness Adjustment Range	0-100%	
Color Temperature Range	2700K-6500K	
CRI/TLCI	CRI \approx 95 TLCI \approx 97	
Illuminance (maximum power, without reflector)	2680(lux)	Lab Data 1
Illuminance (maximum power, with reflector)	10500(lux)	Lab Data 2
ZHIYUN MOLUS Grip Battery Capacity	2550mAh	
ZHIYUN MOLUS Grip Battery Runtime (maximum power)	50min	Lab Data 3
ZHIYUN MOLUS Grip Battery Charging Time	2H 30min	Lab Data 4
ZHIYUN MOLUS Grip Battery USB-C Port Max. Input/Output Power	30W	
DC Power Supply Voltage	DC 24V	
USB Supply Power/ Voltage	$P \geq 18W$ $U \geq 9V$	
Power Adapter Rated Output Voltage/Current	24V/2.7A	
Operation Temperature	-10° C-40° C	
Product Size (without reflector and battery)	100*71*56mm	
ZHIYUN MOLUS Grip Battery Size	94*61*52.8mm	

Product Net Weight (without reflector and battery)	313g
ZHIYUN MOLUS Grip Battery Net Weight	370g

Lab Data 1: The data is collected in the following conditions: No reflectors, 25°C temperature, indoor illuminance lower than 0.1lux, test distance 1m, and the color temperature is set at 6500K with 100% brightness. The illuminance is 2680lux. The actual illuminance varies under different conditions.

Lab Data 2: The data is collected in the following conditions: Installed reflector, 25°C temperature, indoor illuminance lower than 0.1lux, test distance 1m, and the color temperature is set at 6500K with 100% brightness. The illuminance is 10500lux. The actual illuminance varies under different conditions.

Lab Data 3: The data is collected in the following conditions 25°C temperature, ZHIYUN MOLUS grip battery is fully-charged, and the color temperature is set at 6500K with 100% brightness. The battery runtime is 50 min. The actual grip battery runtime varies under different conditions: the longer the operating time, the higher the charge and discharge frequency, and the less the battery activity, leading to a shorter battery runtime.

Lab Data 4: The data is collected at a specified temperature of 25°C with 28W PD Fast Charging. The charging time of the light is 2h 30 min. The actual charging time varies under different conditions: the lower the charging temperature, the lower the charging current, leading to a longer charging time.

Thank you for purchasing this product. The information contains herein affects your safety, legitimate rights and obligation. Please read this instruction carefully to ensure proper configuration before use. Failure to read and follow this instruction and warnings herein may result in serious injury to you or bystanders, or damage to your device or property. Guilin Zhishen Information Technology Co., Ltd (hereinafter referred to as "ZHIYUN") reserves all rights for final explanation of this instruction and other documents related to this product. The information is subject to update without notice. Please visit www.zhiyun-tech.com to obtain the latest product information.

By using this product, you hereby signify that you have read this document carefully and that you understand and agree to abide by the terms and conditions herein. You agree that you are solely responsible for your own conduct while using this product, and for any consequences thereof. You agree to use this product only for purposes that are proper and in accordance with all terms, precautions, practices, policies and guidelines ZHIYUN has made and may make available.

ZHIYUN accepts no liability for damage, injury or any legal responsibility incurred directly or indirectly from the use of this product. Users shall observe safe and lawful practices including, but not limited to, those set forth herein.

ZHIYUN™ is the trademark of Guilin Zhishen Information Technology Co., Ltd and its affiliates. All product names or trademarks referred to herein are trademarks or registered trademarks of their respective holders.

Reading Tips

Legends:  Hints and Tips  Important

Safe Operation Instructions

Read the ENTIRE User Guide to become familiar with the features of this product before operating. Failure to operate the product correctly can result in damage to the product or personal property and cause serious injury. This is a sophisticated product. It must be operated with caution and common sense and requires some basic mechanical ability. Failure to operate this product in a safe and responsible manner could result in injury or damage to the product or other property. This product is not intended for use by children without direct adult supervision. DO NOT use with incompatible components or in any way otherwise as mentioned or instructed in the product documents provided by ZHIYUN. The safety guidelines herein contain instructions for safety, operation and maintenance. It is essential to read and follow all of the instructions and warnings in the User Guide, prior to assembly, setup or use, in order to operate the product correctly and avoid damage or serious injury.

Warranty Period

1. Customers are entitled to replacement or free repair service in case of quality deficits found in the product within 15 days upon receipt of the product.
2. Customers are entitled to free repair service from ZHIYUN for any product proven defective in material or workmanship that results in product failure during normal consumer usage and conditions within the valid warranty period, which is 12 months counting from the date of selling. However, warranty period varies by product component and country of purchase. Please contact our after-sales service team on ZHIYUN official website or your place of purchase for detailed warranty information.

Warranty Exclusions

1. Products subjected to unauthorized repair, misuse, collision, neglect, mishandling, soaking, accident, and unauthorized alteration.
2. Products subjected to improper use or whose labels or security tags have been torn off or altered.
3. Products whose warranty has expired.
4. Products damaged due to force majeure, such as fire, flood, lightning, etc.

Warranty Claim Procedure

1. If failure or any problem occurs to your product after purchase, please contact a local agent for assistance, or you can always contact ZHIYUN's customer service through email at info@zhiyun-tech.com or website at www.zhiyun-tech.com.
2. Your local agent or ZHIYUN's customer service will guide you through the whole service procedure regarding any product issue or problem you have encountered. ZHIYUN reserves the right to reexamine damaged or returned products.

Customer Information

Customer Name:

Phone Number:

Address:

Sales Information

Sales date:

Product Serial Number:

Distributor Name:

Distributor's Contact Number:

First Maintenance Record

Service Date:

Repairman Signature:

Cause of Problem:

Service Result:

 Solved Unsolved Refunded/Replaced



Website



Weibo



Vimeo



Google+



Facebook
(Zhiyun Support)



Facebook
(Zhiyun Tech)



Youku



Youtube



Wechat



Instagram

Tel: +86 400 900 6868

USA Hotline: +1 808-319-6137,9:00-18:00 GMT-7,Mon-Fri

Europe Hotline: +49 (0) 61018132180,10:00-17:00 GMT+1,Mon-Fri

Web: www.zhiyun-tech.com

E-mail: info@zhiyun-tech.com

Address: 09 Huangtong Road, Tieshan Industrial Zone, Qixing District, Guilin, 541004, Guangxi, China

Certificate of Quality

This product is confirmed to meet quality standards and permitted for sale after strict inspection.

QC Inspector: _____



For full product information, please visit ZHIYUN's official website: Content on www.zhiyun-tech.com is subject to update without notice.

ZHIYUN™ is a trademark of ZHISHEN

All product names or brands referred to hereunder may be trademarks or registered trademarks of their respective holders.

Copyright © 2024 ZHISHEN. All rights reserved.

ZHIYUN-TECH.COM